



CATALOGUE

- ENGLISH -

22 | 23



génia



injection



surgery



orthopedics



hospitalization



capture



protection



hygiene



livestock



grooming

■ GÉNIA, A SHARED VISION

For over 70 years, Génia has been committed to delivering **innovative solutions that accurately respond to the needs of animal health professionals, who represent our core business.**

Driven by a passion for animals, a visionary spirit, and an obsession with quality, Bernard Comminges has turned this small family business into an international group dedicated to designing, manufacturing, and distributing a complete range of veterinary equipment.

Traditionally, our sales staff would travel around France to restock clinics using demonstration vans. Nowadays, the vans have gone, but we still maintain a close relationship with veterinarians thanks to our sales teams, both in France and abroad, who inform and advise animal health professionals, thereby contributing both to improvements in the technical skills of veterinary teams and to animal welfare.

This heritage is an integral part of Génia's philosophy, which is centred on quality and proximity to animal health professionals and preserved by bringing our teams together to share **strong values such as trust, ethics and quality, and by remaining true to the founder's vision.**

Génia is also known for having developed a range of Plexiglas hypodermic syringes that are able to withstand repeated sterilisation and are resistant to wear over time. This innovative spirit has fuelled and driven the development of our projects since Génia was founded.

The success of our collaboration with animal health professionals has been largely due to the **combination of our extensive knowledge of the veterinary profession with innovation, in a constant quest for creativity and flexibility.**

FINELY TUNED TO MARKET EXPECTATIONS

The last thirty years have been characterised by significant developments, from the launch of several generations of innovative products to the expansion of our production capacity.

Today, we are moving to a new level in responding to our customers' expectations by acting as a group and through our subsidiaries **in France and abroad, we are able to provide a local presence and propose advanced and innovative technical solutions.**

A PARTNER AT THE FOREFRONT OF RESEARCH

Daily involvement with animal health professionals aids the creation of ever better and more efficient veterinary equipment.

Our Research & Development department stands out in particular thanks to the development of innovative concepts whose usefulness quickly makes them market standards, such as **suture threads, drug guns, automatic syringes and more.**

These new products are **designed and developed in our Saint-Hilaire-de-Chaléons facility and tested with partner users.**

CERTIFIED QUALITY FOR OPTIMAL SERVICE

The implementation of the ISO 9001 standard since 2007 for all our processes, from design to delivery via procurement and production, is a guarantee of quality and reliability in terms of the traceability of our products.

This certification binds all of our teams to a process of continuous improvement in order to establish a maximum level of service in total confidence.

SEE GÉNIA'S COMPREHENSIVE RANGE OF PRODUCTS AND SERVICES, AVAILABLE IN DIFFERENT FORMATS:

- Our catalogue contains a **wide range of over 2,500 items** organised into 9 product families.
- Our website welcomes you with all the newest products and gives you quick access to the information you need: **www.genia.fr/en/**
- Our sales department is at your disposal for any specific studies and requests
 - by phone: **+33 (0)2 40 03 24 17**
 - by email: **genia@genia.fr**

■ GOOD PROSPECTS ON THE EUROPEAN AND OVERSEAS MARKETS

For more than 60 years, Génia has been building up its export business, which now represents one-third of the company's sales.

We attract foreign customers with product lines specifically designed for their markets. Exports have enabled us to increase production and achieve economies of scale to reduce costs.

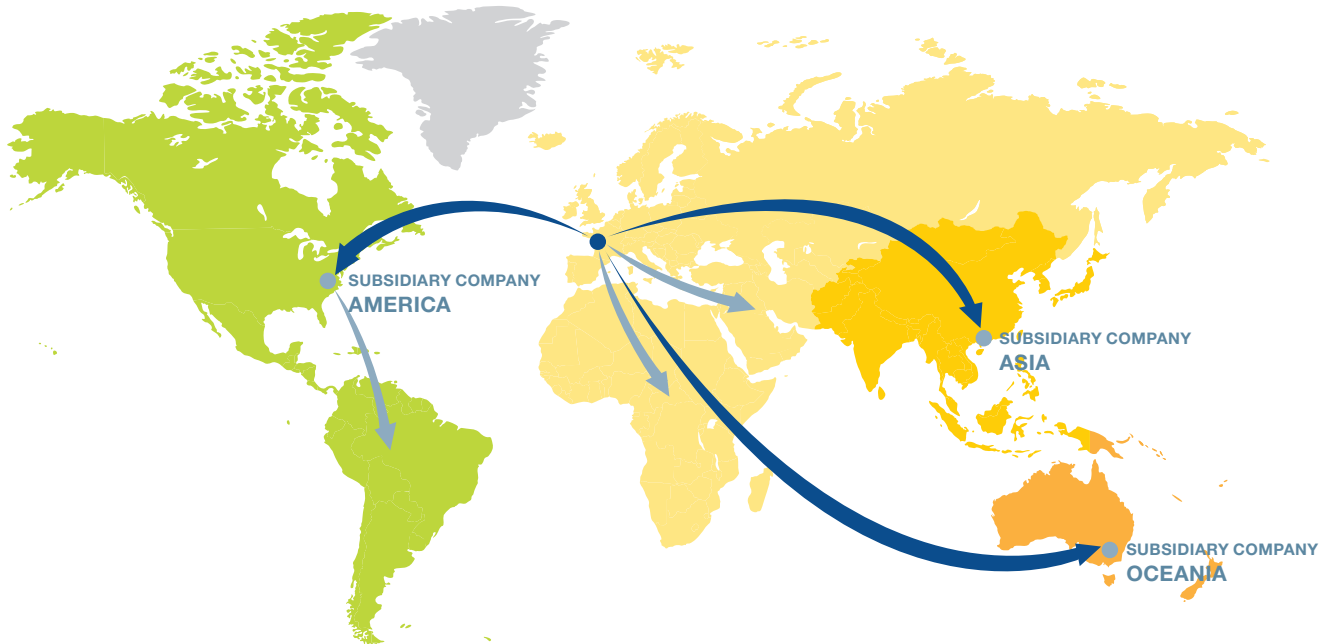

■ Europe, Middle East, Africa: **+33 (0)2 40 03 24 17**

Subsidiaries:

■ America: **+1 917 576 8097**

■ Asia: **+86 189 8857 3879**

■ Oceania : **+61 4 28 112 151**

■ GÉNIA, QUALITY GUARANTEED, OUTSTANDING PERFORMANCE

Génia has been ISO 9001 certified since 2007.

We are fully committed to continuous improvement of our organisation.

Our quality management system is built around our collective commitment to meet our customers' needs in terms of deadlines, products and quality business relations.

Our continuous improvement system helps us serve you better, which is our number one priority.



■ GÉNIA, DESIGN AND ENGINEERING

1. PRODUCT DESIGN: AN INNOVATIVE, CUSTOM SOLUTION

Génia has always emphasised research and development of new solutions to simplify veterinary practice.

Our design and engineering staff concentrate their efforts on constantly improving our product offerings. We upgrade our current products and develop new ones based on customer suggestions and feedback. And, with our vast experience and expertise in veterinary science, we design new equipment and instruments that get rave reviews from our customers.

2. PRODUCTION: EXPERTISE ESSENTIAL FOR INNOVATION

As a market leader in veterinary supplies, Génia invests heavily in our plant and equipment, and our growth strategy includes adding new production capacities.

Our production of small veterinary supplies is divided into six specialised production units:



- **Lathe production unit:**

this workshop works mainly on machining plexiglas for the production of GéniaPlex syringes and on machining steel for the osteosynthesis range.



- **Plastic injection production unit:**

the moulds are used to make a wide range of products such as syringes, drenching guns, ticks remover, suture cases, etc.

- **Electro-mechanical equipment unit:**
this facility makes electric fences, electric prods and tattooing machines.

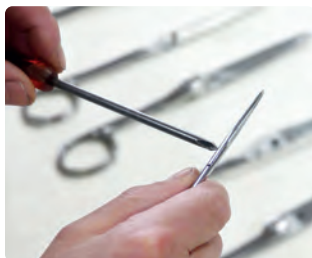

- **Clean room unit:**

this unit packages and sterilizes surgical sutures in a cleanroom.

- **Cutlery production unit:**

this facility specialises in farrier tools (blades), surgical and grooming scissors, as well as repair of surgical instruments.



- **Distinject equipment unit:**

from 2015, manufacture and assembly of animal immobilisation and capture equipment (hypodermic projectors and accessories, poles...).



3. DISTRIBUTION: WE MAKE EVERY EFFORT TO GET YOU YOUR ORDER AS QUICKLY AS POSSIBLE

We have set up a state-of-the-art logistics system.

The delivery process is totally automated, including order tracking, production, inventory management and shipping, as part of our ISO 9001 certification.

With a storage capacity of 3,600 pallets, Génia's goal is to guarantee the availability of our products, in a timely manner.



injection



surgery



orthopedics



hospitalization



capture



protection



hygiene



livestock



grooming

CONTENTS

● Injection	7
● Surgery	37
● Orthopedics	57
● Hospitalization	69
● Capture	87
● Protection	121
● Hygiene	127
● Livestock	133
● Grooming	157
Index	159



INJECTION

Hypodermic syringes

Plexiglas syringes	8
Manual syringes	10
Semi-automatic and automatic syringes	12
Disposable syringes	14
Replacement parts	16
Syringe accessories	17

Needles

Reusable hypodermic needles	18
Disposable hypodermic needles	20
Detectable disposable hypodermic needles	22
Specific needles and needle accessories	23

Infusion sets, sampling, catheters

Catheters	25
Infusion sets	27
Other catheters and tubing	34

■ GÉNIAPLEX

Hypodermic plexiglas syringes for professionals.

- Manufactured from a solid block of plexiglas that is treated to avoid deformation and cracking.
- Stainless steel plungers, rods and handles and chromium-plated Zamac caps.
- Flat, bevelled silicone washers are extra strong, water resistant and nonstick, providing a perfect washer and smoothly sliding plunger.
- Sterilisation: resistant to boiling water and autoclave up to 125°C (30 min - 1.3 bars), but not to alcohol.
- No contraindication for use with standard pharmaceutical products.
- Can be entirely disassembled.
- Black indelible graduations.
- Nickel-plated brass bibloc Luer-Lock hub.

Supplied in a polyethylene bag with instructions for use, 6 extra washers and a 10 mL silicone oil bottle.

On demand:

- syringes with a screw rod,
- Recordfix and Rotlauf Luer-Lock monobloc hubs.



IDEAL FOR
INTENSIVE USE

Code	Model	Capacity	Washer	Graduation	Hub
100002	Standard	1 mL	9-14	0.1 mL	Concentric
100003	Standard	2 mL	9-14	0.1 mL	Concentric
100004	Standard	3 mL	9-14	0.1 mL	Concentric
100006	Long	5 mL	9-14	0.1 mL	Concentric
100007	Short	5 mL	14-20	0.5 mL	Concentric
100008	Standard	10 mL	14-20	0.5 mL	Concentric
100010	Standard	20 mL	20-28	1 mL	Eccentric
100032	Standard	20 mL	20-28	1 mL	Concentric
100014	Long	30 mL	20-28	1 mL	Eccentric
100036	Long	30 mL	20-28	1 mL	Concentric
100012	Short	30 mL	24-32	2 mL	Eccentric
100034	Short	30 mL	24-32	2 mL	Concentric
100018	Long	50 mL	24-32	2 mL	Eccentric
100040	Long	50 mL	24-32	2 mL	Concentric
100016	Short	50 mL	30-40	2 mL	Eccentric
100038	Short	50 mL	30-40	2 mL	Concentric
100022	Long	60 mL	24-32	2 mL	Eccentric
100020	Short	60 mL	30-40	2 mL	Eccentric
100026	Long	100 mL	30-40	2 mL	Eccentric
100048	Long	100 mL	30-40	2 mL	Concentric
100024	Short	100 mL	40-50	5 mL	Eccentric
100046	Short	100 mL	40-50	5 mL	Concentric
100028	Standard	200 mL	40-50	5 mL	Eccentric
100050	Standard	200 mL	40-50	5 mL	Concentric

[p.16](#) Find hubs and washers

[p.18](#) Find Delvo needles

■ GÉNIAPLEX 300 ML

Hypodermic plexiglas syringe for professional use.

- Extruded plexiglas barrel.
- Bottom, cap and plunger made of polished aluminium.
- Aluminium rod and handle made of unbreakable and non-deformable plastic.
- Can be entirely disassembled.
- Flat and bevelled silicone washer.
- Can be converted into a drenching syringe.
- Sterilisation: resistant to boiling water.
- Black indelible graduations.
- Concentric Bibloc Luer-Lock hub.
- To convert into a drenching syringe, replace the hub and adapter with a 10 mm diameter long nozzle (code 187040 or 186052 p.138).

Supplied in a polyethylene bag with an extra washer and a 10 mL silicone oil bottle.

On demand: Recordfix and Rotlauf Luer-Lock monobloc hubs.



Code	Model	Capacity
A 104850	Hypodermic syringe	300 mL

SPARE PARTS

Code	Model
B 189625	Reducer with needle hub seal

[p.16](#) Find hubs and washers

■ LONG GÉNIAPLEX

Extra-long hypodermic syringes, same type as Géniaplex syringes for professionals.

- Identical to Géniaplex syringes.
- Total length 65 cm.
- Rigid extension made of anodised aluminium.
- Dose adjustment by rotating the extension screw that passes through the cap of the syringe.
- Dose unlocking by unscrewing the locknut.
- Monobloc concentric Luer-Lock hub.

On demand:

- others lengths available,
- Recordfix and Rotlauf hubs.

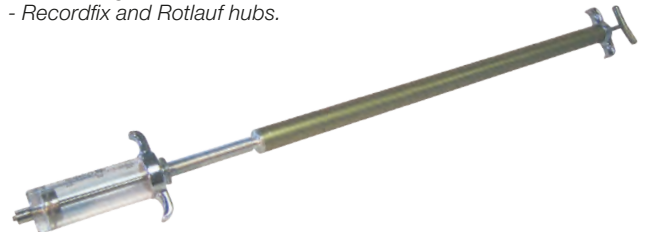

Code adjustable	Code non-adjustable	Model	Capacity	Washer	Graduation
100410	100530	Short	5 mL	14-20	0.5 mL
100412	100531	Standard	10 mL	14-20	0.5 mL
100414	100532	Standard	20 mL	20-28	1 mL
100416	100533	Short	30 mL	24-32	2 mL
100418	100534	Short	50 mL	30-40	2 mL

[p.16](#) Find hubs and washers



■ GÉNIAMATIC WITH TUBING

Automatic Géniaplex syringes with 4/7 mm tubing.

- Identical to Géniaplex syringes.
- Dose adjustment by rotating the screw that passes through the cap of the syringe.
- Dose unlocking by unscrewing the locknut.
- Valve assembly with stainless steel springs and plastic or metal precision ground balls.
- 10 and 20 mL models can be adjusted from 5 to 10 mL and from 10 to 20 mL respectively.
- Bibloc Luer-Lock hub.

Supplied in a cardboard box with 1 m of flexible PVC tubing, washers and valves set and a 10 mL silicone oil bottle, **without an air needle**.
On demand: 0.3 mL, 0.5 mL, 1 mL, 10 mL and 20 mL syringes.



Code	Capacity	Washer	Graduation	Adjustment range
100451	2 mL	9-14	0.1 mL	from 0 to 2 mL
100453	5 mL	14-20	0.5 mL	from 0 to 5 mL

[p.23 Find air needles](#)

[p.16 Find hubs and washers](#)

[p.16 Find ball, spring and washer kit](#)

■ LONG GÉNIAMATIC

Automatic, extra-long, adjustable Géniaplex syringes.

Same type as Géniamatic and long Géniaplex syringes.

- Identical to Géniaplex, long Géniaplex, and automatic Géniaplex syringes.
- Bibloc concentric Luer-Lock hub.

Supplied complete with 4/7 mm flexible PVC tubing and a 20 cm air needle.

On demand: 10 mL and 20 mL syringes.



Code	Capacity	Washer	Graduation axis
100470	5 mL	14-20	0.5 mL

ACCESSORIES

Code	Model
140504	1.5 m Ø 4/7 mm tubing

[p.16 Find hubs and washers](#)

[p.16 Find ball, spring and washer kit](#)



METALPLEX®

Non-deformable moulded plastic hypodermic syringes with indelible engraved graduations.

- Removable nickel-plated brass plunger, cap and rod.
- Sterilisation: resistant to boiling water and autoclave up to 134°C (30 min - 1.5 bars).
- No contraindication for use with standard pharmaceutical products.
- Flat, bevelled, extra-strong, water-resistant, non-stick silicone washers, guaranteeing a perfect seal and a smooth sliding of the plunger.
- Nickel-plated brass hub.

Supplied in a polyethylene bag with instructions for use.

On demand:

- 20 mL, 30 mL and 50 mL syringes with concentric hub,
- Recordfix and Rotlauf hubs.

Code monobloc	Code bibloc	Capacity	Washer	Graduation	Hub
102020	102030	5 mL	9-14	0.1 mL	Concentric
102021	102031	10 mL	14-20	0.5 mL	Concentric
102022	102032	20 mL	20-28	1 mL	Eccentric
102023	102033	30 mL	24-32	2 mL	Eccentric
102024	102034	50 mL	30-40	5 mL	Eccentric



[p.16 Find hubs and washers](#)

[p.17 Find drenching nozzles](#)

LONG METALPLEX®

Extra-long hypodermic syringes, same type as Metalplex®.

- Identical to Metalplex® syringes.
- Total length 65 cm.
- Rigid extension made of anodised aluminium.
- Monobloc concentric Luer-Lock hub.
- Non-adjustable.

On demand: Recordfix and Rotlauf hubs.

Code	Capacity	Washer	Graduation
102600	10 mL	14-20	0.5 mL
102602	20 mL	20-28	1 mL
102603	30 mL	24-32	2 mL
102605	50 mL	30-40	5 mL



[p.16 Find washers](#)

DOSIPLEX

Same as Metalplex® and Eplex® non-deformable hypodermic syringe but with a screw rod.

- Identical to Metalplex® and Eplex® syringes.
- Concentric monobloc hub.
- Reinforced clear plastic caps.
- Chromed Zamac rod-handles with flat sides and engraved graduations.
- Nickel-plated brass plunger and screw rod.

Supplied in a polyethylene bag with instructions for use.

On demand:

- 20 mL, 30 mL and 50 mL syringes with eccentric hub,
- Recordfix and Rotlauf hubs.

Code	Capacity	Washer	Graduation
102210	5 mL	9-14	0.5 mL
102211	10 mL	14-20	1 mL
102212	20 mL	20-28	1 mL
102213	30 mL	24-32	1 mL
102214	50 mL	30-40	5 mL



[p.18 Find needles](#)



■ HYPODERMIC SYRMAN

Translucent plastic hypodermic syringes with indelible engraved graduations.

- Sterilisation: resistant to boiling water and autoclave.
- No contraindication for use with standard pharmaceutical products.
- Can be entirely disassembled.
- Silicone washer.
- Can be converted into a drenching syringe.
- Plunger, rod and handle made of unbreakable plastic.
- Concentric hub.
- To convert into a drenching syringe, replace the hub and adapter with a 10 mm diameter nozzle (code **187040** or **186052**, p. 138).

Supplied in a polyethylene bag with a reducer, a washer (code **189500**), a bibloc Luer-Lock hub and a 10 mL silicone oil bottle.

On demand: monobloc, Recordfix and Rotlauf hubs.



SYRINGES

	Code	Model	Capacity
A	104800	Complete hypodermic syringe	300 mL
	104801	Complete hypodermic syringe	450 mL
B	104804	Syringe with sow uterine catheter hub	450 mL

ACCESSORIES

	Code	Model
C	187032	Uterine catheter hub (p.16)
D	189625	Reducer with needle hub seal (p.138)

p.16 Find hubs and washers

■ ELPLEX®

Moulded plastic hypodermic syringes with engraved graduations.

- Plastic plunger, cap and handle, nickel-plated brass rod, non-removable.
- Sterilisation: resistant to boiling water and autoclave up to 134°C (30 min - 1.5 bars).
- No contraindication for use with standard pharmaceutical products.
- Flat, bevelled, extra-strong, water-resistant, non-stick silicone washers, guaranteeing a perfect seal and smooth sliding of the plunger.
- Nickel-plated brass hub.

Supplied in a polyethylene bag with instructions for use.

On demand:

- 20 mL, 30 mL and 50 mL syringes with concentric hub,
- Recordfix and Rotlauf hubs.



■ POLYMEX

Hypodermic syringes, same type as Elplex® but in translucent plastic.

- Same type as Metalplex® and Elplex® syringes.
- Engraved graduations.
- Non-deformable.
- Monobloc hubs.

Supplied in a polyethylene bag with instructions for use.

On demand:

- 20 mL, 30 mL and 50 mL syringes with concentric hub,
- Recordfix and Rotlauf hubs.



Code monobloc	Code bibloc	Capacity	Washer	Graduation	Hub
103002	103010	5 mL	9-14	0.1 mL	Concentric
103003	103011	10 mL	14-20	0.5 mL	Concentric
103004	103012	20 mL	20-28	1 mL	Eccentric
103005	103013	30 mL	24-32	2 mL	Eccentric
103006	103014	50 mL	30-40	5 mL	Eccentric
103504	-	20 mL	20-28	1 mL	Concentric
103505	-	30 mL	24-32	2 mL	Concentric
103506	-	50 mL	30-40	5 mL	Concentric

Code	Size	Washer	Graduation	Hub
104000	5 mL	9-14	0.1 mL	Concentric
104002	10 mL	14-20	0.5 mL	Concentric
104003	20 mL	20-28	1 mL	Eccentric
104004	30 mL	24-32	2 mL	Eccentric
104005	50 mL	30-40	5 mL	Eccentric

p.16 Find hubs and washers

p.16 Find hubs and washers



REVOLROUX

Semi-automatic fixed-dose syringes.

- Graduations from 0.25 to 5 mL according to the model.
- Glass barrels and silicone washers.
- Luer-Lock hub.



Code	Capacity	Graduation
107800	10 mL	0.25 - 0.5 - 1 mL
107803	20 mL	0.5 - 1 - 2 - 3 - 3.5 mL
107805	30 mL	1 - 2 - 3 - 4 - 5 mL
107810	50 mL	1 - 2 - 3 - 4 - 5 mL

Outer packaging:
Master case of 25 boxes.

ACCESSORIES

Code	Model
107861	Washers for plunger and barrel 10 mL
107862	Washers for plunger and barrel 30-50 mL

EXTENDED ROUX

Semi-automatic fixed-dose syringes.

- Graduations from 1 to 5 mL.
- Glass barrels and silicone washers.
- Luer-Lock hub.



Code	Capacity	Dosis
107270	50 mL	1 - 2 - 3 - 4 - 5 mL

ACCESSORIES

Code	Model
107262	Washers for plunger and barrel 50 mL

TUBMATIC®

Moulded plastic automatic syringe with 1.5 meters of 4/7 mm tubing with engraved graduations on the barrel.

- Can be completely disassembled.
- Sterilisation: resistant to boiling water and autoclave up to 134°C (autoclave: completely disassemble the syringe, do not sterilise handles).
- More compact than standard models for the same dose, using a patented system in which the spring and adjustment screw are not stacked.
- The syringe can be held in two positions for **ease of use**.
- Dose adjustment by turning the barrel on the front handle. This innovation brings the operator's hand closer to the animal when the dose is smaller, for greater **precision** and easier handling.
- Ergonomic handles with V-shaped washer for **leverage** and ease of use.
- Easy lubrication of the barrel washer simply by removing the unit from the front valve assembly.
- Valve assembly with stainless steel springs and plastic ball bearings to prevent the valves from sticking to the walls.
- The needle is locked in the Luer hub by a cap with a flat surface that protects the animal from the hub.
- Flat silicone seals, bevelled, highly resistant, hydrophobic, non-stick, ensuring perfect sealing and slight sliding of the piston for models with plastic hub (A) and O-rings for models with metal hub (B).
- High-tech, sterilisable materials, resistant to pharmaceutical products.

Supplied individually in a polyethylene bag with instructions for use, washers and valves set, and a 10 mL silicone oil bottle.



TUBMATIC® TUBE

A	B	Capacity	Diameter int.	Graduation
Code plastic hub	Code metal hub			
105000	105002	2 mL	9 mm	0.1 mL
105010	105012	5 mL	14 mm	0.5 mL

FLAMATIC®

Automatic syringe made from moulded plastic with indelible engraved graduations of the barrel.

- Identical to Tubmatic® syringes.
- Bottle adapter at the back for better support, and easy handling of bottles from 10 to 100 mL. This innovative device ensures flexibility and freedom of movement.
- Bottle adapter fits 3 neck diameters, meaning all models on the market:
 - 5 mL bottles,
 - 10 mL to 100 mL bottles,
 - 250 mL and 500 mL bottles with large necks.

Supplied individually in a polyethylene bag with instructions for use, washers and valves set, and a 10 mL silicone oil bottle.

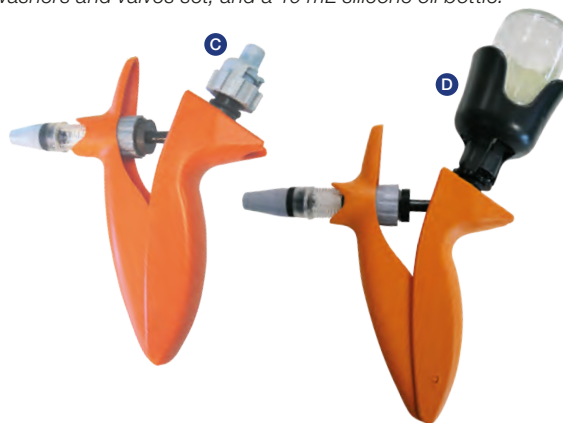

C FLAMATIC® NUT

Code plastic hub	Code metal hub	Capacity	Diameter int.	Graduation
105020	105022	2 mL	9 mm	0.1 mL
105025	105027	5 mL	14 mm	0.5 mL

D FLAMATIC® BOTTLE ADAPTOR

Code plastic hub	Code metal hub	Capacity	Diameter int.	Graduation
105080	105082	2 mL	9 mm	0.1 mL
105085	105087	5 mL	14 mm	0.5 mL

ACCESSORIES

Code	Model
106196	Valves and springs set (common to all models)
140504	1.5 m Ø 4/7 mm tubing

p.16 Find hubs and washers



INJECTMASTER®

Moulded plastic automatic syringe.

- Sterilisation: resistant to boiling water.
- Plastic or metal monobloc Luer-Lock hub.
- Ergonomics designed to reduce user effort and to limit musculoskeletal discomfort. Reduces the risks of tendonitis with intensive use.
- Fast, accurate dose adjustment using the "select-a-dose system" (for adjustable models).
- Anti-slip surface on front handle.
- Customisable (please contact us for minimum quantities).
- Interchangeable silicone valves and stainless steel springs.
- Easy lubrication of the plunger seal by removing the barrel.
- Medical-grade material does not react with common pharmaceuticals.
- Durable superior quality plastic.
- Bottle holder on the rear for better support, easy handling and use of heavy bottles (250 and 500 mL, for example). This innovative feature ensures flexibility and freedom of movement.
- Plastic outer shell protects the bottle from rupture during handling.
- Plastic hub models for possible use with Sterimatic-type needle protection systems.

Supplied in a polyethylene bag with valves, springs, seals and teats set, instructions for use, a 10 mL silicone oil bottle and 1.50 mm 4/7 mm diameter tubing (for tube models).



COMPATIBLE WITH FLAMATIC® NUTS SYSTEM



INJECTMASTER® TUBE

A	B			
Code Plastic hub	Code Metal hub	Model	Capacity	Graduation
186313	186312	Fixed dose tube	1 mL	-
186321	186320	Fixed dose tube	2 mL	-
186329	186328	Fixed dose tube	5 mL	-
186315	186314	Adjustable dose tube	1 mL	0.1 mL
186323	186322	Adjustable dose tube	2 mL	0.2 mL
186331	186330	Adjustable dose tube	5 mL	0.5 mL



INJECTMASTER® BOTTLE ADAPTOR*

C	D			
Code Plastic hub	Code Metal hub	Model	Capacity	Graduation
186309	186308	Fixed dose bottle adaptor	1 mL	-
186317	186316	Fixed dose bottle adaptor	2 mL	-
186325	186324	Fixed dose bottle adaptor	5 mL	-
186311	186310	Adjustable dose bottle adaptor	1 mL	0.1 mL
186319	186318	Adjustable dose bottle adaptor	2 mL	0.2 mL
186327	186326	Adjustable dose bottle adaptor	5 mL	0.5 mL

*Supplied without nuts set.

ACCESSORIES

Code	Model
106155	3 nuts set (T1, T2, T3)
186790	Valves, springs, seals and teats set
140504	1.5 m Ø 4/7 mm tubing

p.16 Find hubs and washers

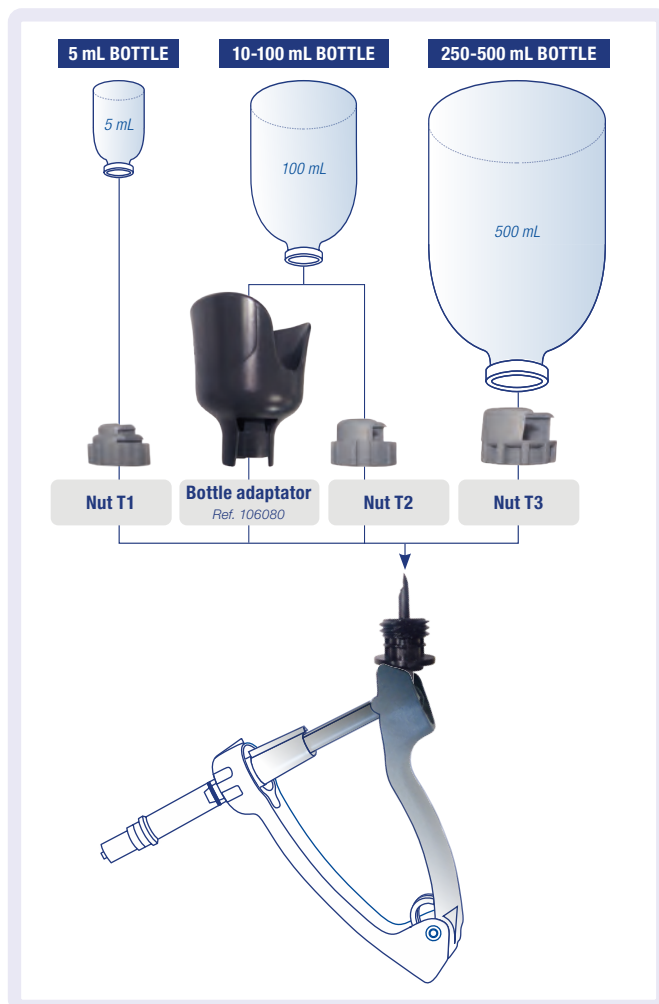

Watch the video version on our website and our Youtube channel !



Presentation



Instructions for use



DISPOJECT® 3 PIECES SYRINGES

Disposable syringes without needle, made of polypropylene.

- Latex-free, silicone-free, DEHP-free, BPA-free and styrene-free.
- Pointed plunger in the 1 ml model to prevent loss of product with small volumes.
- Quick and easy graduation reading.
- Luer base, except force-feeding syringes.

Supplied individually sterile wrapped in boxes of 30, 50 and 100.

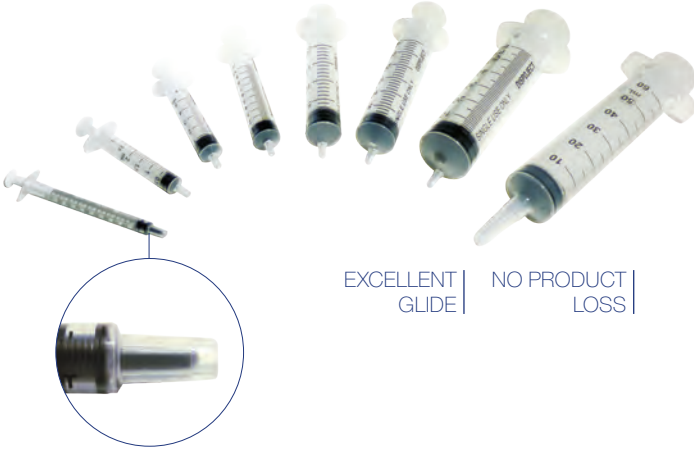

EXCELLENT GLIDE | NO PRODUCT LOSS

1 mL tuberculin model

Code	Capacity	Graduation	Hub	Pack	O/pack.**
107140	1 mL*	0.1 mL	Concentric Luer	x 100	x 36
107142	2 mL	0.1 mL	Concentric Luer	x 100	x 32
107144	5 mL	0.2 mL	Concentric Luer	x 100	x 24
107146	10 mL	0.2 mL	Eccentric Luer	x 100	x 15
107148	20 mL	1 mL	Eccentric Luer	x 50	x 16
107150	30 mL	1 mL	Eccentric Luer	x 50	x 12
107152	50 mL	1 mL	Eccentric Luer	x 30	x 12
107154	50 mL	1 mL	Feeding	x 30	x 12

*Tuberculin model.
**Number of boxes.



DISPOJECT® 2 PIECES SYRINGES

Disposable syringes without needle, made of polypropylene.

- Latex-free, silicone-free, DEHP-free, BPA-free, styrene-free.
- Luer hub.

Supplied individually sterile wrapped in boxes of 50 and 100.

Code	Capacity	Graduation	Hub	Pack.	O/pack.*
107162	2 mL	0.1 mL	Concentric Luer	x 100	x 25
107164	5 mL	0.2 mL	Concentric Luer	x 100	x 20
107166	10 mL	0.2 mL	Eccentric Luer	x 100	x 12
107168	20 mL	1 mL	Eccentric Luer	x 50	x 16

*Number of boxes.



p.21 Find disposable hypodermic syringes



DISPOJECT® STANDARD INSULIN SYRINGE

3 parts 40 IU insulin syringe of 1 ml with a 29G extra-fine overmolded needle.

- Sterile, disposable, latex-free.
- Needle with a protective cap.

Supplied individually sterily wrapped in boxes of 100.

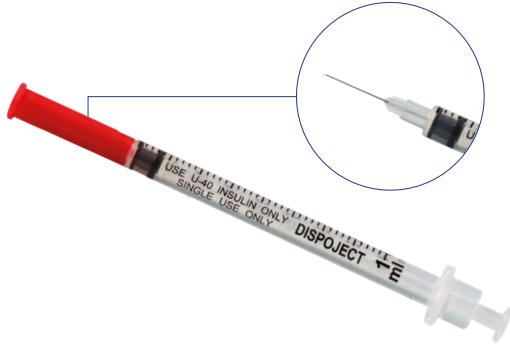

Code x 100	Capacity	Graduation
107135	1 mL	1 IU

Outer packaging :
master case of 36 boxes



DISPOJECT® SAFETY INSULIN SYRINGE

3 parts 40 IU insulin syringe of 1 ml with a 29G extra-fine overmolded needle.

- Sterile, disposable, latex-free.
- Secured insulin syringe with a unique, innovative protection system which lets you cap the needle once you have used the syringe, to avoid pricking yourself.
- It offers safety and comfort.

Supplied individually sterily wrapped in boxes of 100.



 **LOCK,
YOU ARE SECURE !**

Code x 100	Capacity	Graduation
107136	1 mL	1 IU

Outer packaging :
master case of 20 boxes



Watch the video version
on our website !

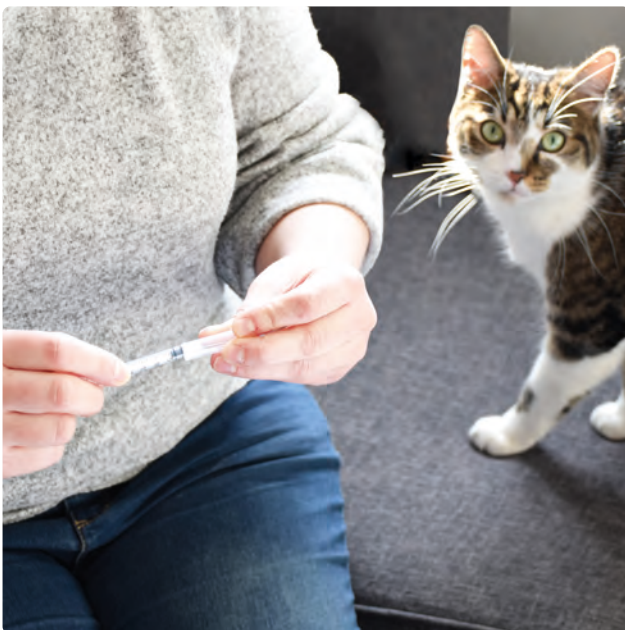

■ SYRINGE ADAPTERS

Nickel-plated brass adapters for 4/7 PVC tubing.



	Code	Model
A+B	106050	Male Luer-Lock/olive
A	106046	Male Luer/olive
B	109304	Luer-Lock connector
C	106048	Female Luer/olive
D	106051	Male olive/no screw for hypodermic syringes
E	140482	Male Luer/male record (plastic) for Imoplast (p.32)
F	106008	Olive tip for injection extension stick hub (p.17)

■ HUBS

Hubs for Géniaplex, Metalplex®, Elplex®, Polymex, Flamatic® and Tubmatic® metal syringes.

Supplied with washer.

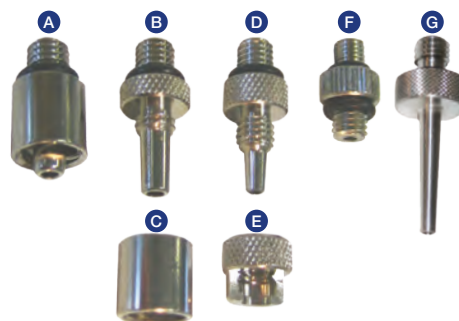

	Code	Model
A	109300	Luer-Lock hub monobloc
B+C	109306	Luer-Lock hub bibloc
B	109302	Threaded Luer hub
C	109304	Luer-Lock connector
D+E	109312	Recordfix hub
D	109310	Record hub (Pravaz) threaded
E	109314	Recordfix connector
F	109308	Hub with screw (Rotlauf)
G	187032	Uterine catheter hub, use without reducer (Syman syringe)

■ VALVE ASSEMBLIES

Valve assemblies for automatic Géniamatic syringes.

- Precision cut chrome-plated brass.
- Polished ball bearings to prevent sticking to the inner walls.
- Interchangeable Luer-Lock hub.

Supplied complete with 1 meter 4/7 tubing.

Code	Model
106032	Valve assembly for 0.3 to 0.5 mL Géniamatic with tubing
106030	Valve assembly for 1 to 20 mL Géniamatic with tubing
106033	Valve assembly for 0.3 to 0.5 mL Géniamatic - bottle adaptor
106034	Valve assembly for 1 to 20 mL Géniamatic - bottle adaptor

ACCESSORIES

Code	Model
106043	Balls, springs and washers set (for all Géniamatic valve assemblies)

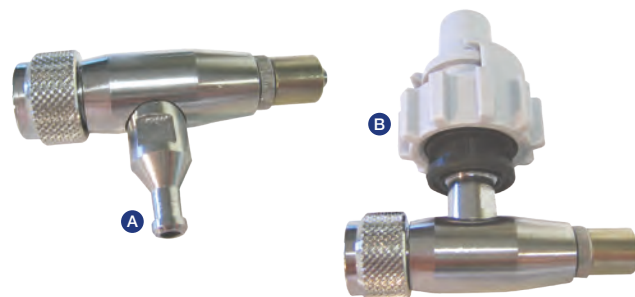

p.9 Find Géniamatic syringes

■ SYRINGE WASHERS

Common washers for normal and automatic Géniaplex syringes, Metalplex®, Elplex®, Polymex, Tubmatic®, Flamatic® and Drugmatic syringes, plastic models, syringes with screw plunger, normal and automatic extra-long syringes.

- Flat silicone washers (except the 0.3 and 0.5 mL nitrile O-rings), moulded according to Génia standards, bevelled, extra-strong, with constant shore hardness across the entire surface. Water-resistant, non-stick.
- Guaranteed perfect seal and smooth sliding of the plunger.

Supplied by 6.

On demand: washers in bulk from 100 parts.

	Code x6	Model	Washer
A	109253	0.3 mL	4-14
B	109257	0.5 mL	5-14
C	109265	1, 2, 3, 5 mL long	9-14
D	109266	5 mL short, 10 mL	14-20
E	109267	20, 30 mL long	20-28
F	109268	30 mL short, 50 mL long, 60 mL long	24-32
G	109269	50 mL short, 60 mL court, 100 mL long	30-40
H	109270	100 mL short, 200 mL long, 300 mL plexi	40-50

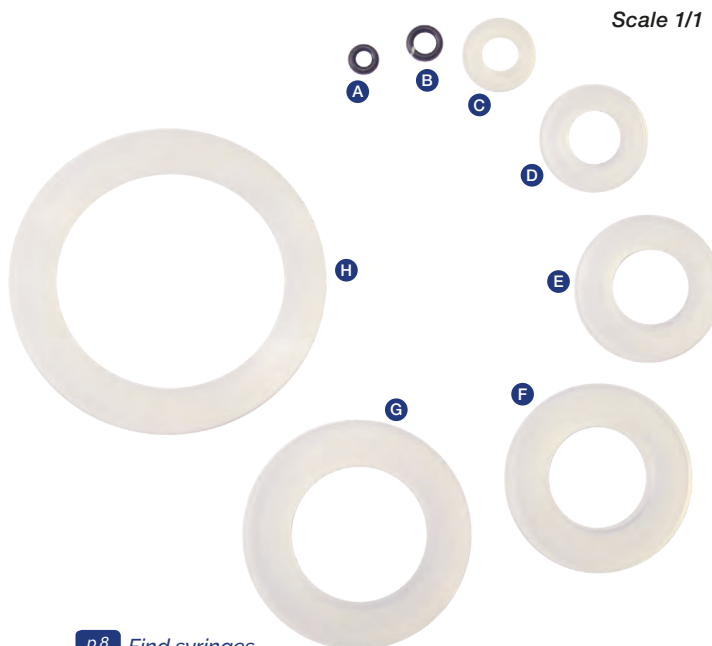

p.8 Find syringes



SILIGLISS

Thick silicone for lubricating the washers of syringes and drenching guns.

Supplied individually, by 20 and 40.



Code	Model	Pack.
106023	Tube 10 mL	x 40
106021	Tube 30 mL	x 20
106024	Tube 1 L	by unit

DRENCHING NOZZLES

Brass drenching nozzles adaptable to hypodermic syringes and Drugmatic (p.136).

- 10.5 cm length.
- 6 mm diameter.
- For sheep, goats and small animals.



	Code	Model
A	106025	Luer-Lock model attaches to hub
B	187036	Model with screw in place of the hub

INJECTION EXTENSION STICK

Light and rigid injection extension (70 cm) for remote access.

- 0.80 m reinforced tubing between the syringe and the extension.
- Fits all types of syringes.
- Anodised aluminium.
- Reinforced tubing for injecting viscous products.
- Monobloc Luer-Lock hub.
- Plastic handle.
- Overall length of the tubing 1.5 m (volume of 19 mL).

On demand: other lengths and hubs available.

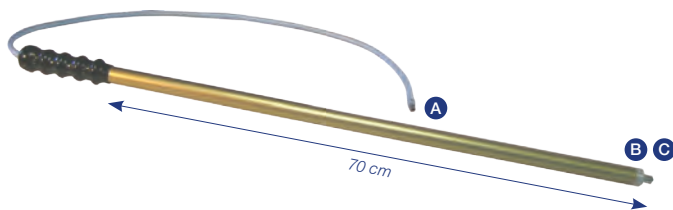

	Code	Model
	106002	Complete extension 70 cm
	106007	Reinforced tubing (one meter)
A	106048	Female Luer/olive
B	106008	Olive tip for needle hub
C	109300	Luer-Lock hub monobloc

INJECTION HARNESS

Multi-purpose harness (injection, Pour-On or drenching) designed for operator comfort and safety.

- Two chest pockets with double zipper receiving bottles up to 500 mL.
- One back pocket receiving tanks from 1 to 5 L.
- Belt equipped with two adjustable pockets (clean and used needles) and a holster to secure an injector.
- Machine washable and fast drying.

Supplied individually with two carabiners hook.



Code	Model
227296	Injection harness



DELVO STANDARD QUALITY

Stainless steel hypodermic needles, standard quality.

- Medium tri-bevelled.
- 6% taper, Luer-Lock.
- 16 mm squared hub.

Supplied in boxes of 12.

On demand: other sizes available.

Code x 12	Length	Size (G)	Code x 12	Length	Size (G)
147399	4 x 0.7 mm	22G x 1/8"	147437	20 x 1.6 mm	16G x 3/4"
147400	10 x 0.7 mm	22G x 3/8"	147435	25 x 1.6 mm	16G x 1"
147403	10 x 1.0 mm	19G x 3/8"	147468	15 x 1.8 mm	15 G x 5/8"
147404	13 x 1.0 mm	19G x 1/2"	147470	20 x 1.8 mm	15G x 3/4"
147406	15 x 1.0 mm	19G x 5/8"	147472	25 x 1.8 mm	15G x 1"
147409	20 x 1.0 mm	19G x 3/4"	147473	30 x 1.8 mm	15G x 1 1/4"
147411	15 x 1.2 mm	18G x 5/8"	147476	50 x 1.8 mm	15G x 2"
147412	20 x 1.3 mm	18G x 3/4"	147440	10 x 2.0 mm	14G x 3/8"
147415	30 x 1.3 mm	18G x 1 1/4"	147439	15 x 2.0 mm	14G x 5/8"
147418	10 x 1.5 mm	17G x 3/8"	147442	20 x 2.0 mm	14G x 3/4"
147421	15 x 1.5 mm	17G x 5/8"	147443	25 x 2.0 mm	14G x 1"
147423	16 x 1.5 mm	17G x 5/8"	147445	30 x 2.0 mm	14G x 1"
147424	20 x 1.5 mm	17G x 3/4"	147448	40 x 2.0 mm	14G x 1 1/2"
147427	25 x 1.5 mm	17G x 1"	147451	50 x 2.0 mm	14G x 2"
147430	30 x 1.5 mm	17G x 1 1/4"	147454	60 x 2.0 mm	14G x 2 1/2"
147433	40 x 1.5 mm	17G x 1 1/2"	147456	30 x 2.2 mm	13G x 1 1/4"
147436	50 x 1.5 mm	17G x 2"	147458	35 x 2.2 mm	13G x 1 3/8"
147438	15 x 1.6 mm	16G x 5/8"	147460	40 x 2.2 mm	13G x 1 1/2"

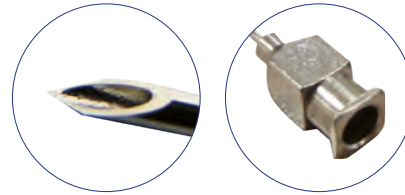

Outer packaging:
master case of 12 boxes

DELVO VETERINARY QUALITY

Stainless steel hypodermic needles, veterinary and professional quality.

- Medium tri-bevelled, counter sharpened and rounded heel.
- 6% taper, Luer-Lock.
- 17.8 mm rectangular hub; excellent handling.

Supplied in boxes of 12.

On demand: other sizes available.

Code x 12	Length	Size (G)	Code x 12	Length	Size (G)
147003	4 x 0.7 mm	22G x 1/8"	147048	10 x 2.0 mm	14G x 3/8"
147010	10 x 0.7 mm	22G x 3/8"	147049	15 x 2.0 mm	14G x 5/8"
147011	7 x 1.0 mm	19G x 1/5"	147052	20 x 2.0 mm	14G x 3/4"
147013	10 x 1.0 mm	19G x 3/8"	147053	25 x 2.0 mm	14G x 1"
147015	12 x 1.0 mm	19G x 4/9"	147055	30 x 2.0 mm	14G x 1 1/4"
147016	15 x 1.0 mm	19G x 5/8"	147058	40 x 2.0 mm	14G x 1 1/2"
147019	20 x 1.0 mm	19G x 3/4"	147061	50 x 2.0 mm	14G x 2"
147022	20 x 1.3 mm	18G x 3/4"	147064	60 x 2.0 mm	14G x 2 1/2"
147025	30 x 1.3 mm	18G x 1 1/4"	147067	70 x 2.0 mm	14G x 2 3/4"
147028	10 x 1.5 mm	17G x 3/8"	147070	80 x 2.0 mm	14G x 3 1/4"
147031	15 x 1.5 mm	17G x 5/8"	147073	150 x 2.0 mm	14G x 6"
147034	20 x 1.5 mm	17G x 3/4"	147076	70 x 2.5 mm	13G x 2 3/4"
147037	25 x 1.5 mm	17G x 1"	147078	25 x 3.0 mm	11G x 1"
147040	30 x 1.5 mm	17G x 1 1/4"	147080	30 x 3.0 mm	11G x 1 1/4"
147043	40 x 1.5 mm	17G x 1 1/2"	147082	60 x 3.0 mm	11G x 2 1/2"
147046	50 x 1.5 mm	17G x 2"	147085	50 x 3.5 mm	10G x 2"



Outer packaging:
master case of 12 boxes



DERMASTEEL

Stainless steel hypodermic needles with reinforced walls, standard quality.

- Short tri-bevelled.
- 6% taper, Luer-Lock.
- 14 mm hub.

Supplied in boxes of 12.

Code x 12	Length	Size (G)	Code x 12	Length	Size (G)
147886	25 x 0.6 mm	23G x 1"	147942	15 x 1.5 mm	17G x 5/8"
147890	10 x 0.7 mm	22G x 3/8"	147943	20 x 1.5 mm	17G x 3/4"
147891	13 x 0.7 mm	22G x 1/2"	147944	25 x 1.5 mm	17G x 1"
147894	25 x 0.7 mm	22G x 1"	147945	30 x 1.5 mm	17G x 1 1/4"
147903	13 x 0.8 mm	21G x 1/2"	147946	40 x 1.5 mm	17G x 1 1/2"
147906	25 x 0.8 mm	21G x 1"	147951	13 x 1.6 mm	16G x 1/2"
147910	6 x 0.9 mm	20G x 1/4"	147953	20 x 1.6 mm	16G x 3/4"
147911	13 x 0.9 mm	20G x 1/2"	147954	25 x 1.6 mm	16G x 1"
147913	20 x 0.9 mm	20G x 3/4"	147955	30 x 1.6 mm	16G x 1 1/4"
147914	25 x 0.9 mm	20G x 1"	147956	40 x 1.6 mm	16G x 1 1/2"
147917	40 x 0.9 mm	20G x 1 1/2"	147959	12 x 1.8 mm	15G x 1/2"
147920	10 x 1.0 mm	19G x 3/8"	147960	13 x 1.8 mm	15G x 1/2"
147921	13 x 1.0 mm	19G x 1/2"	147962	15 x 1.8 mm	15G x 5/8"
147922	15 x 1.0 mm	19G x 5/8"	147963	20 x 1.8 mm	15G x 3/4"
147923	20 x 1.0 mm	19G x 3/4"	147964	25 x 1.8 mm	15G x 1"
147924	25 x 1.0 mm	19G x 1"	147965	30 x 1.8 mm	15G x 1 1/4"
147925	30 x 1.0 mm	19G x 1 1/4"	147966	40 x 1.8 mm	15G x 1 1/2"
147926	40 x 1.0 mm	19G x 1 1/2"	147970	10 x 2.0 mm	14G x 3/8"
147931	13 x 1.3 mm	18G x 1/2"	147971	13 x 2.0 mm	14G x 1/2"
147933	20 x 1.3 mm	18G x 3/4"	147972	15 x 2.0 mm	14G x 5/8"
147934	25 x 1.3 mm	18G x 1"	147973	20 x 2.0 mm	14G x 3/4"
147935	30 x 1.3 mm	18G x 1 1/4"	147974	25 x 2.0 mm	14G x 1"
147936	40 x 1.3 mm	18G x 1 1/2"	147975	30 x 2.0 mm	14G x 1 1/4"
147940	10 x 1.5 mm	17G x 3/8"	147976	40 x 2.0 mm	14G x 1 1/2"
147941	13 x 1.5 mm	17G x 1/2"	147977	50 x 2.0 mm	14G x 2"



Outer packaging:
master case of 12 boxes

p.24 [Find the equivalence chart for hypodermic needles](#)

NEEDLE SCALE

1:1

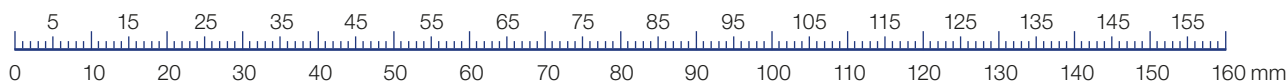

HYPOJET®

Stainless steel sterile disposable hypodermic needles for large animals, veterinary quality.

- Medium tri-bevelled with silicone-coated cannula.
- Polypropylene hub.
- 6% taper, Luer-Lock.

Supplied in boxes of 100.



Code x 100	Length	Size (G)	Code x 100	Length	Size (G)
147485*	9 x 0.8 mm	21G x 3/8"	147365	50 x 1.5 mm	17G x 2"
147376	6 x 0.9 mm	20G x 1/4"	147392	25 x 1.6 mm	16G x 1"
147371	16 x 1.1 mm	19G x 5/8"	147360	38 x 1.6 mm	16G x 1 1/2"
147373	6 x 1.3 mm	18G x 1/4"	147369	30 x 2.0 mm	14G x 1 1/4"
147374	13 x 1.3 mm	18G x 1/2"	147361	38 x 2.0 mm	14G x 1 1/2"
147372	16 x 1.3 mm	18G x 5/8"	147364	50 x 2.0 mm	14G x 2"
147366	50 x 1.3 mm	18G x 2"	147362	60 x 2.0 mm	14G x 2 1/2"
147367	20 x 1.5 mm	17G x 3/4"	147363	80 x 2.0 mm	14G x 3 1/4"
147368	30 x 1.5 mm	17G x 1 1/4"			

Outer packaging:

master case of 50 and 100 boxes
*master case of 40 boxes

GENALU

Stainless steel sterile hypodermic needles, veterinary quality.

- Long tri-bevelled with silicone-coated cannula.
- Aluminium hub.
- 6% taper, Luer-Lock.

Supplied in boxes of 100.



Code x 100	Length	Size (G)
147694	16 x 1.3 mm	18G x 5/8"
147696	25 x 1.3 mm	18G x 1"
147704	20 x 1.6 mm	16G x 3/4"
147706	25 x 1.6 mm	16G x 1"
147708	38 x 1.6 mm	16G x 1 1/2"
147700	25 x 2.0 mm	14G x 1"
147702	38 x 2.0 mm	14G x 1 1/2"
147710	50 x 2.0 mm	14G x 2"

Outer packaging:

master case of 10 and 40 boxes

MONOJECT

Stainless steel sterile hypodermic needles, veterinary quality.

A: long bevel. B: short bevel. I: medium bevel.

- Tri-bevelled with silicone-coated cannula.
- Aluminium hub.
- 6% taper, Luer-Lock.

Supplied in boxes of 100.



Code x 100	Length	Size (G)	Bevel
147277	16 x 1.3 mm	18G x 5/8"	B
147275	25 x 1.3 mm	18G x 1"	A
147278	20 x 1.6 mm	16G x 3/4"	I
147280	25 x 1.6 mm	16G x 1"	A
147290	38 x 1.6 mm	16G x 1 1/2"	A
147282	38 x 1.6 mm	16G x 1 1/2"	B
147283	25 x 2.0 mm	14G x 1"	I
147284	38 x 2.0 mm	14G x 1 1/2"	I

Outer packaging:
master case of 10 boxes

p.24 Find the equivalence chart for hypodermic needles

NEEDLE SCALE

1:1

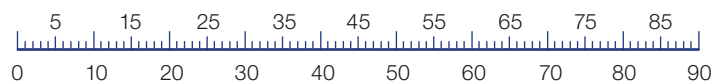

DISPOJECT® NEEDLES

Stainless steel, sterile disposable hypodermic needles in professional, veterinary quality.

- Injection-optimised for veterinary practice with a triple-bevel **medium** point, sharpened to reduce tissue irritation.
- Siliconised tube for better sliding, to improve the animal's comfort and healing.
- Numerous models to suit all species and all situations (blood samples, intradermal injections, cystocentesis...).
- Conicity 6% Luer-Lock.
- Epoxy resin base.
- Ethylene oxide sterilisation.
- Latex-free, DEHP-free.

Supplied in boxes of 100.

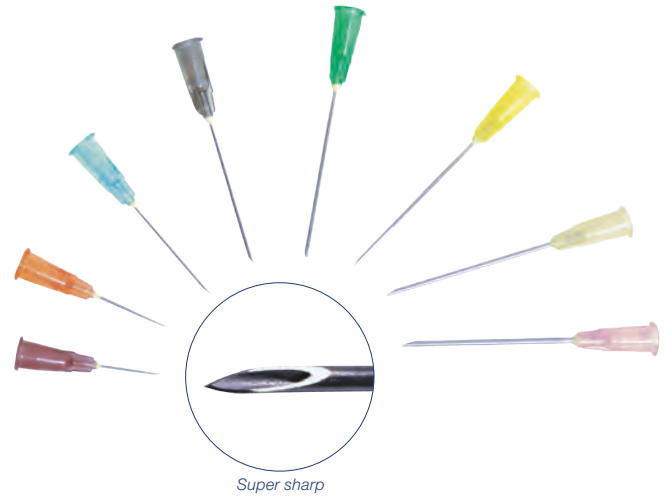

Code x 100	Length	Size (G)	Code x 100	Length	Size (G)
147750	13 x 0.45 mm	26G x 1/2"	147766	38 x 0.8 mm	21G x 1 1/2"
147752	16 x 0.5 mm	25G x 5/8"	147768	50 x 0.8 mm	21G x 2"
147754	16 x 0.6 mm	23G x 5/8"	147770	25 x 0.9 mm	20G x 1"
147756	25 x 0.6 mm	23G x 1"	147772	38 x 0.9 mm	20G x 1 1/2"
147757	16 x 0.7 mm	22G x 5/8"	147774	25 x 1.1 mm	19G x 1"
147758	32 x 0.7 mm	22G x 1 1/4"	147776	38 x 1.1 mm	19G x 1 1/2"
147760	38 x 0.7 mm	22G x 1 1/2"	147778	50 x 1.1 mm	19G x 2"
147762	16 x 0.8 mm	21G x 5/8"	147780	38 x 1.2 mm	18G x 1 1/2"
147764	25 x 0.8 mm	21G x 1"			

Outer packaging:
master case of 20 and 100 boxes
master case of 30 boxes for 50 mm needles

VETERINARY QUALITY | SILICONE COATED CANNULA



PRIMAJECT®

NEW

Stainless steel, sterile, disposable hypodermic needles, standard quality.

A: long bevel. B: short bevel.

- Tri-bevelled and silicone-coated cannula.
- 6% taper, Luer-Lock.
- Epoxy resin hub.
- Sterilised with ethylene oxide.
- Latex-free, DEHP-free.

Supplied in boxes of 100.

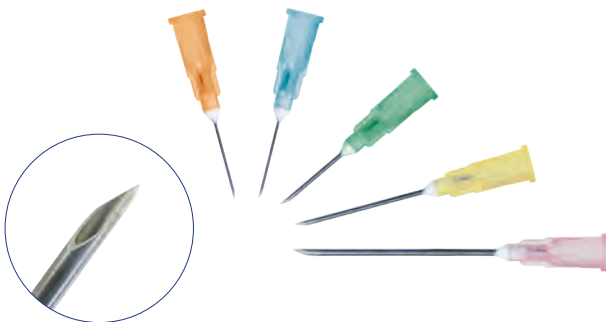

Code x 100	Length	Size (G)	Bevel
147602	0,5 x 16 mm	25G x 5/8"	A
147604	0,6 x 16 mm	23G x 5/8"	A
147608	0,6 x 25 mm	23G x 1"	A
147616	0,8 x 16 mm	21G x 5/8"	A
147618	0,8 x 25 mm	21G x 1"	A
147624	0,9 x 25 mm	20G x 1"	A
147634	1,2 x 38 mm	18G x 1 1/2"	B

Outer packaging:
master case of 20 and 100 boxes



■ PLASTI-DETECT®

Disposable, sterile detectable hypodermic needles.

- Detectable stainless steel cannula: detectable by any type of metal detector such as those used in food processing plants.
- Detectable because of steel composition.
- Plastic hub, colour depending on the diameter.
- Long tri-bevelled.
- 6% taper, Luer-Lock.

Supplied in boxes of 100.



Code x 100	Length	Size (G)
148285 ●	9 x 0.8 mm	21G x 3/8"
148287 ●	16 x 0.8 mm	21G x 5/8"
148290 ●	50 x 0.8 mm	21G x 2"
148292 ●	16 x 1.1 mm	19G x 5/8"
148295 ●	50 x 1.1 mm	19G x 2"
148300 ●	40 x 1.2 mm	18G x 1 1/2"
148303 ●	16 x 1.3 mm	18G x 5/8"
148305 ●	25 x 1.3 mm	18G x 1"
148308 ●	50 x 1.3 mm	18G x 2"
148310 ●	20 x 1.5 mm	17G x 3/4"
148312 ●	30 x 1.5 mm	17G x 1 1/4"
148314 ●	50 x 1.5 mm	17G x 2"

Outer packaging:
master case of 10 and 40 boxes

■ ALU-DETECT®

Disposable, sterile detectable hypodermic needles.

- Identical to PLASTI-DETECT® needles.
- Aluminium hub.

Supplied in boxes of 100.



Code x 100	Length	Size (G)
148218	38 x 1.6 mm	16G x 1 1/2"
148220	50 x 2.0 mm	14G x 2"

Outer packaging:
master case of 10 and 40 boxes

NEEDLE SCALE

1:1

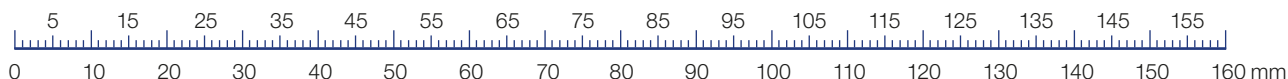

RUMEN NEEDLE

Stainless steel needle of veterinary quality.

- Tri-bevelled.
 - Counter sharpened.
 - Rounded heel.
 - 6% taper, Luer-olive hub.
- Supplied in boxes of 12.



Code x 12	Length	Size (G)
147090	160 x 4 mm	8G x 6 3/8"

AIR NEEDLES

Air needles with double wall for air intake.

- Usable with the automatic Géniamatic (p.9), Tubmatic® (p.12) and Injectmaster® (p.13) syringes.
- Tip for PVC 4/7 tubing.



Code	Length
106040	9 cm
106041	20 cm

OLIVE-TIP NEEDLE

Olive-tip needle for flexipack.



Code	Diameter		Length	Cannula length
	int.	ext.		
187030	2 mm	2,99 mm	58 mm	40 mm

[p.8 Find syringes](#)

SHARPS CONTAINERS

Disposable containers for medical waste with tamper-proof lid, conform to the French standard NF X30.511.

- Material reduces toxic emissions during incineration.
- 0.5, 2 or 5 L capacities.

On demand: available in 10 L.



	Code	Capacity	O/pack.
	148503	0.5 L	x 40
A	148502	2 L	x 50
B	148500	5 L	x 30

GARFLEX

Tourniquet with plastic fastening system offering 2 possibilities:

- Gradually reduce the pressure.
- Instantly release the strap over elastic tissue.

Code	Dimensions
307860	390 x 25 mm



FLAT TOURNIQUET

Flat natural latex tourniquet.

Code	Dimensions
307865	750 x 20 mm























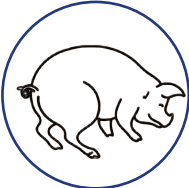







EQUIVALENCE CHART FOR HYPODERMIC NEEDLES

THE CHOICE DEPENDS ON THE VETERINARIAN'S CLINICAL ASSESSMENT

IV: INTRAVENOUS

IM: INTRAMUSCULAR

SC: SUB CUTANEOUS

		Length x diameter		
	CATTLE	IV	60 x 2.0 mm	
		IV	50 x 2.0 mm	
	CALF	IM	50 x 1.3 mm	
		IV IM	30 x 1.5 mm	
		IV	30 x 2.0 mm	
		IV IM	40 x 1.5 mm	
		IM	25 x 1.0 mm	
		IM SC	25 x 1.5 mm	
			PIG	IM
IM	50 x 1.3 mm			
IM	50 x 1.1 mm			
IM	40 x 1.5 mm			
IM	40 x 1.2 mm			
IM	30 x 2.0 mm			
IM SC	30 x 1.5 mm			
	PIGLET			IM SC
		IM	16 x 1.1 mm	
		IM	16 x 0.8 mm	
	SHEEP	IM	25 x 1.0 mm	
		IM	15 x 1.5 mm	
		IM	10 x 1.0 mm	
		IM SC	20 x 1.5 mm	
	POULTRY RABBIT	IM	20 x 0.6 mm	
		IM	13 x 0.9 mm	
		IM	4 x 0.7 mm	



ANIVEN®

NEW



Veterinary FEP intravenous catheter with flexible movable wings mounted on an internal needle with a triple bevel tip.

- Veterinary grade needle with long triple bevel for excellent pricking and efficient, painless placement **A**.
- Optimal glide thanks to the silicone covering the needle and the catheter.
- Silicone-coated Teflon Fluoroethylene Propylene (FEP) catheter designed to prevent kinking during catheter placement **B**.
- Transparent viewing chamber for immediate visualisation of blood reflux.
- Hygienic porous membrane calibrated to allow blood to rise quickly into the viewing chamber without overflow **C**.
- Ergonomic finger rest for optimal fit **D**.
- Movable and flexible wings with two grooves to adapt perfectly to the animal's limb **E**.
- Catheter can be fixed using sutures, thanks to the two holes present on the wings.
- Luer-Lock cap with the colour code of the catheter **F**.

Supplied individually sterilely wrapped in boxes of 12.

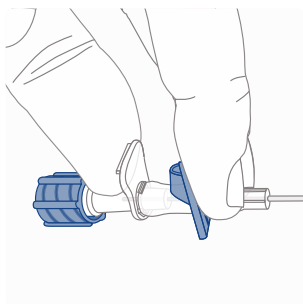
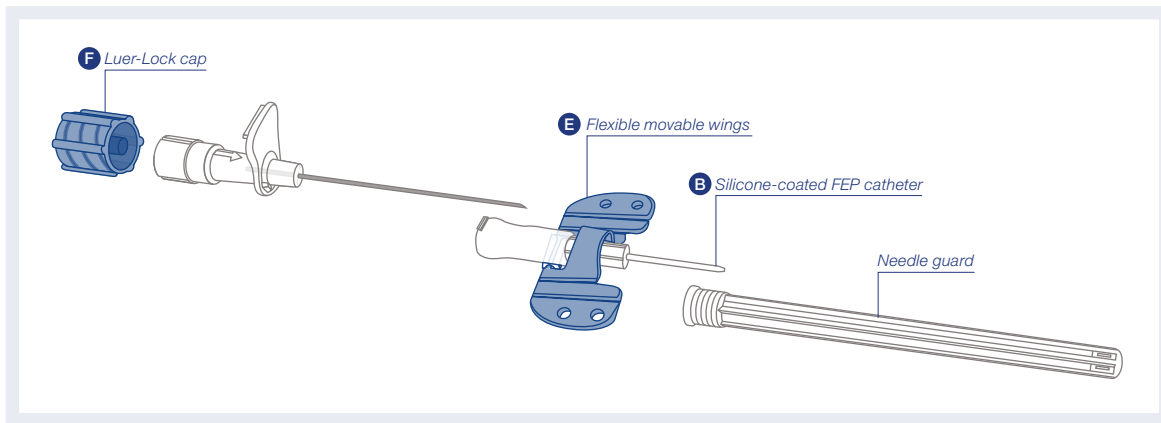
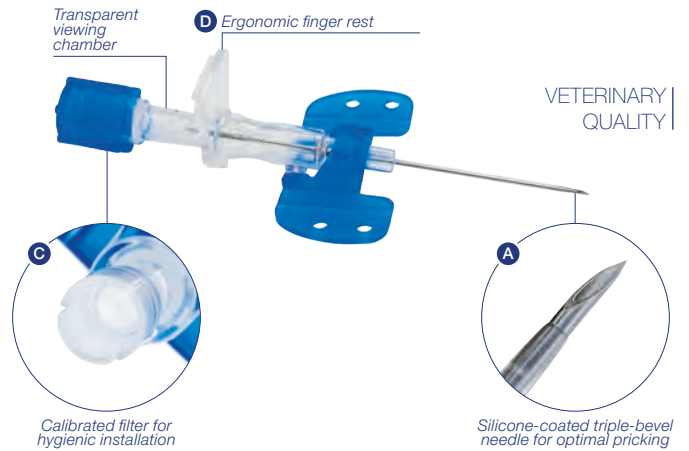

ERGONOMIC CATHETER

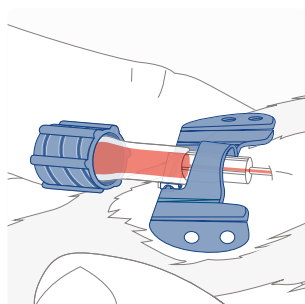

OPTIMISED MAINTENANCE

Watch the video version on our website !



Code x 12	Length	Size (G)	Ext. diameter
157850	19 mm	24G x 3/4"	0.7 mm
157852	25 mm	22G x 1"	0.9 mm
157854	33 mm	20G x 1 1/4"	1.1 mm
157856	45 mm	18G x 1 3/4"	1.3 mm

Outer-packaging :
master case of 24 boxes

■ INTRAFLO

PTFE intravenous catheters, with internal needle.

Intravenous butterfly catheter mounted on a needle with a tri-bevelled point.

- The needle's Luer-Lock hub includes a visualisation chamber and a porous seal.
- Individual sterile packaging.

Supplied in boxes of 50.



A SHORT INTRAFLO

Code x 50	Length	Size (G)	Outside diameter
157190	18 mm	24 G x 3/4"	0.7 mm
157192	24 mm	22 G x 1 1/8"	0.8 mm
157194	30 mm	20 G x 1 1/4"	1 mm
157196	38 mm	18 G x 1 1/2"	1.3 mm
157198	52 mm	16 G x 2"	1.6 mm
157200	52 mm	14 G x 2"	2.1 mm
157202	52 mm	13 G x 2"	2.4 mm
157204	52 mm	12 G x 2"	2.7 mm

B LONG INTRAFLO

Code x 50	Length	Size (G)	Outside diameter
157208	36 mm	20 G x 1 1/2"	1 mm
157209	47 mm	18 G x 1 3/4"	1.3 mm
157210	60 mm	16 G x 2 1/2"	1.6 mm
157212	80 mm	14 G x 3 1/4"	2.1 mm
157214	80 mm	13 G x 3 1/4"	2.4 mm
157216	80 mm	12 G x 3 1/4"	2.7 mm

Outer packaging:
master case of 20 boxes

■ INTRANULE

Polypropylene intravenous catheters with an internal needle.

Intravenous butterfly catheter mounted on a needle with a tri-bevelled point.

- The needle's Luer-Lock hub includes a visualisation chamber and a porous seal.
- Individual sterile blister packaging.

Supplied in boxes of 50.



Code x 50	Length	Size (G)	Outside diameter
157268	105 mm	18 G x 4 1/4"	1.2 mm
157270	105 mm	16 G x 4 1/4"	1.6 mm
157271	50 mm	16 G x 2"	1.6 mm
157272	105 mm	14 G x 4 1/4"	2.0 mm
157274	105 mm	13 G x 4 1/4"	2.3 mm

Outer packaging:
master case of 18 boxes

■ INFUJECT

Multipurpose PVC tubes with male and female Luer-Lock hubs.

- Can be placed on manual and automatic syringes with a Luer-Lock hub or as an infusion extension.

Supplied individually sterilely wrapped in boxes of 12.

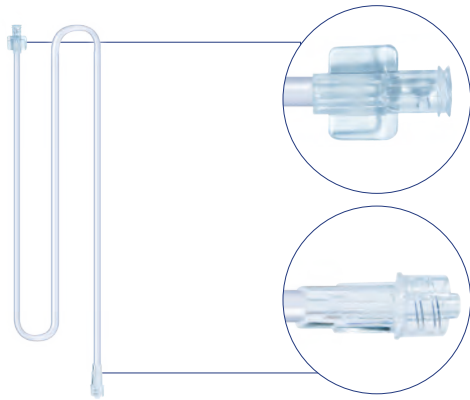

LIPID-RESISTANT | REINFORCED MODEL

Code x 12	Diameter		Length	Tube capacity
	Int.	Ext.		
157404	1.6 mm	2.5 mm	50 cm	1 mL
157406	3 mm	4 mm	25 cm	1.76 mL
157405	3 mm	4 mm	50 cm	3.53 mL
157407	3 mm	4 mm	70 cm	3.7 mL



Outer packaging:
master case of 48 boxes



■ INFUJECT-TRIO

Polyvalent extensions with 3 way stop-cock.

- An injection port 11 cm from the Luer-Lock connection.
- 3-way stop cock, slide clamp with injection port.
- Fixed Luer-Lock hub with protective cap.
- Useful for different types of puncture and as an infusion extension.

Supplied individually sterilely wrapped in boxes of 12.

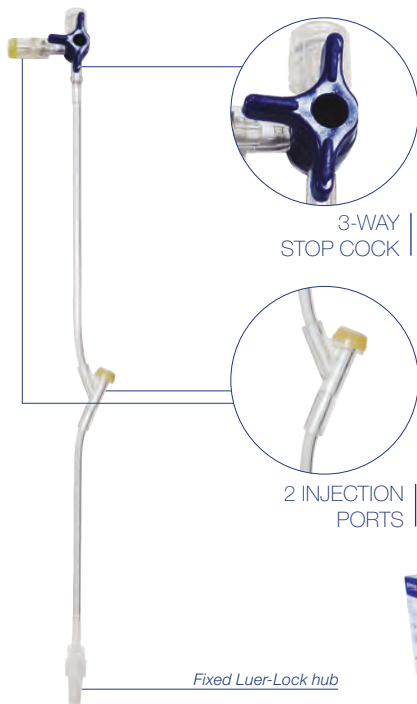

3-WAY STOP COCK

2 INJECTION PORTS

Fixed Luer-Lock hub



Code x 12	Diameter		Length	Tube capacity
	Int.	Ext.		
157319	2.5 mm	4 mm	25 cm	1.75 mL

■ INFUJECT-SITE

Polyvalent PVC extensions with Luer-Lock hub.

- Can be connected to any type of infuser compatible with infusion pumps.
- Injection port 5 cm from the infusor line connection.
- Slide clamp fitted.
- Mobile Luer-Lock connector with protective cap.
- Available in 2 lengths.

Supplied individually sterilely wrapped in boxes of 25 with 2 caps packed separately in sterile bags.

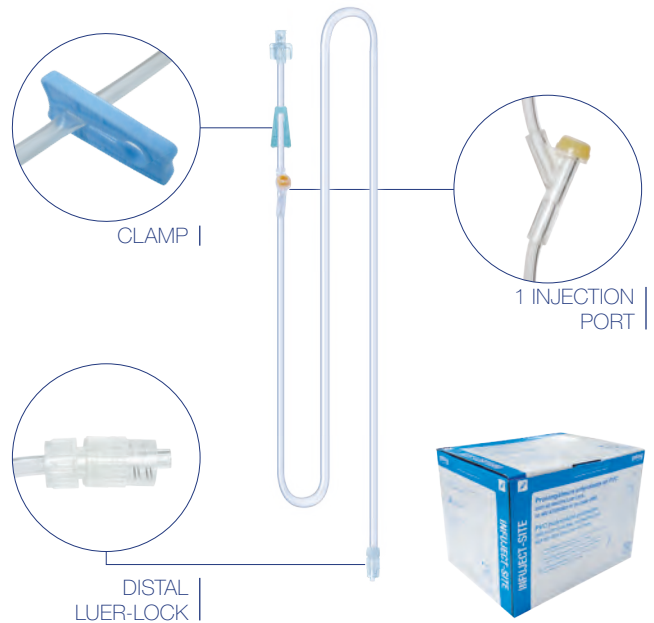

CLAMP

1 INJECTION PORT

DISTAL LUER-LOCK



Code x 25	Diameter		Length	Tube capacity
	Int.	Ext.		
157399	2.9 mm	4.1 mm	26.5 cm	2.08 mL
157400	2.9 mm	4.1 mm	100 cm	6.72 mL



PERFUVET® SOLO

NEW

Long infusion set with one injection port for **SMALL ANIMALS**.

- Precise flow control roller clamp.
- Calibration: **20 drops/mL**.
- For animals over 5 kg.
- Long **180 cm** PVC tube.
- One injection port at 17 cm from the Luer-Lock connector.
- Convenient clear and flexible drip chamber to control the flow and to allow for easy priming.
- Sharp spike to ensure easy piercing of any bottle.
- Closable venting.
- Mobile Luer-Lock connector with protective cap.
- Slide clamp fitted.

Supplied individually sterile wrapped in boxes of 12.

Code x 12	Model
157394	Perfuvet® Solo

Outer packaging:
master case of 12 boxes

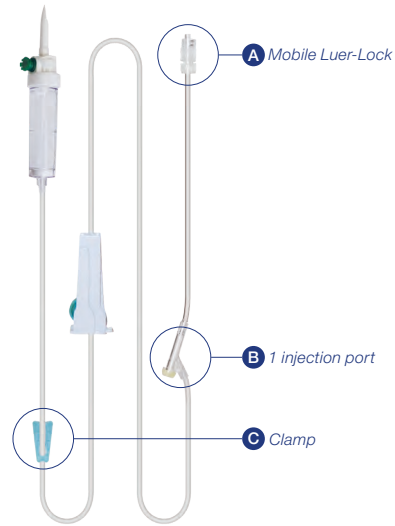

20 DROPS/ML |

PERFUVET® DUO

Extra-long infusion set with two injection ports for **SMALL ANIMALS**.

- Ideal for surgery if the injection port is inaccessible or if the patient is aggressive.
- Precise flow control roller clamp.
- Calibration: **20 drops/mL**.
- For animals over 5 kg.
- Extra-long **200 cm** PVC tube to avoid using extension tubes.
- Two injection ports at 20 cm and 110 cm from the Luer-Lock connector.
- Convenient clear and flexible drip chamber to control the flow and to allow for easy priming.
- Sharp spike to ensure easy piercing of any bottle.
- Closable venting.
- Mobile Luer-Lock connector with protective cap.
- Slide clamp fitted.

Supplied individually sterile wrapped in boxes of 12.

Code x 12	Model
157395	Perfuvet® Duo

Outer packaging:
master case of 12 boxes

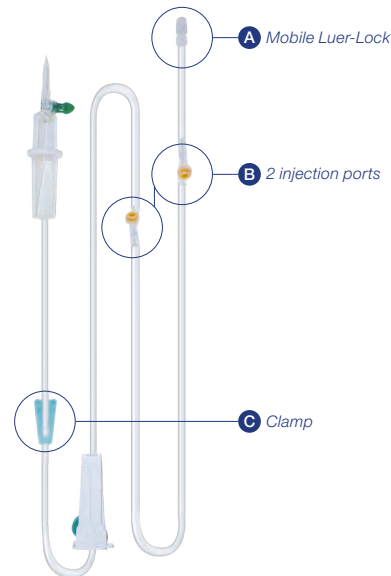

20 DROPS/ML | 2 INJECTION PORTS |

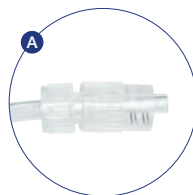

MOBILE LUER-LOCK

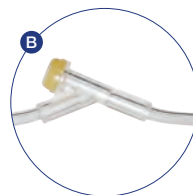

INJECTION PORT

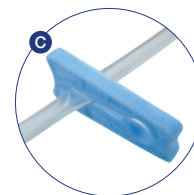

CLAMP



■ PERFUVET® PLUG

Extra-long infusion set with two injection ports and Luer-Lock hub for **SMALL ANIMALS**.

- Ideal for surgery if the injection port is inaccessible or if the patient is aggressive.
- Luer-Lock hub at 5 cm from the first injection port making it possible to easily disconnect the infusion to move the animal.
- Precise flow control roller clamp.
- Calibration: **20 drops/mL**.
- For animals over 5 kg.
- Extra-long **200 cm** PVC tube.
- Two injection ports at 20 cm and 110 cm from the Luer-Lock connector.
- Convenient clear and flexible drip chamber to control the flow and to allow for easy priming.
- Sharp spike to ensure easy piercing of any bottle.
- Closable venting.
- Mobile Luer-Lock connector with protective cap.
- Slide clamp fitted.
- Delivered assembled for easy use, with 2 caps packed separately in a sterile bag.

Supplied individually sterile wrapped in boxes of 12.

Code x 12	Model
157397	Perfuvet® Plug

Outer packaging:
master case of 12 boxes

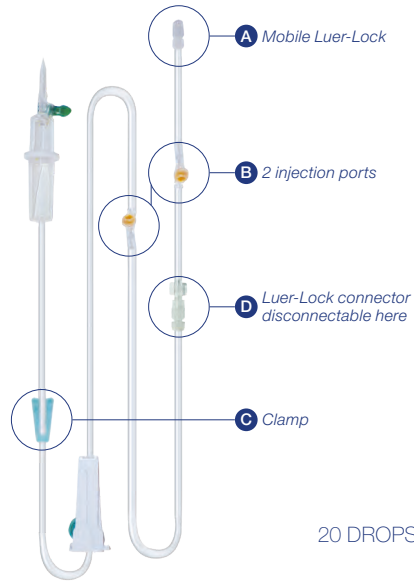

20 DROPS/ML | LUER-LOCK CONNECTOR

■ PERFUVET® MICRO

Micro IV infusion set with two injection ports for **VERY SMALL ANIMALS** (puppies, kittens, exotics).

- Luer-Lock hub at 5 cm from the first injection port making it possible to easily disconnect the infusion to move the animal.
- Flow regulator to refine the infusion.
- Calibration: **60 drops/mL**.
- For animals less than 5 kg.
- Extra-long **200 cm** PVC tube.
- Two injection ports at 20 cm and 110 cm from the Luer-Lock connector.
- Convenient clear and flexible drip chamber to control the flow and to allow for easy priming.
- Sharp spike to ensure easy piercing of any bottle.
- Closable venting.
- Mobile Luer-Lock connector with protective cap.
- Slide clamp fitted.

Supplied individually sterile wrapped in boxes of 12.

Code x 12	Model
157398	Perfuvet® Micro

Outer packaging:
master case of 12 boxes

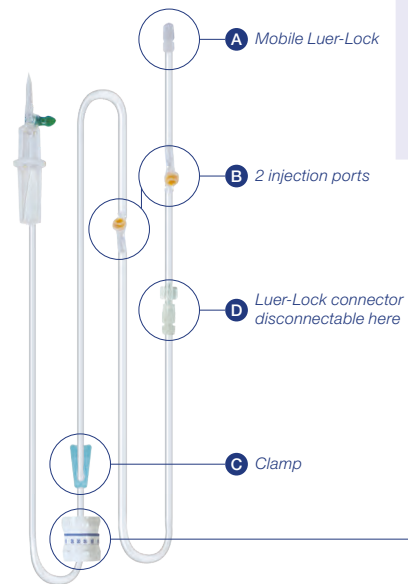

3 IN 1
- 2 injection ports
- Integrated extension
- Flow regulator

60 DROPS/ML | FLOW REGULATOR

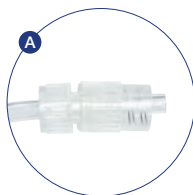

MOBILE LUER-LOCK

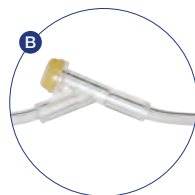

INJECTION PORT

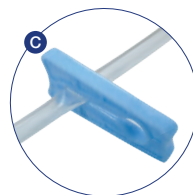

CLAMP

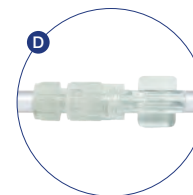

LUER-LOCK CONNECTOR



■ PERFUVET® TWIST

Anchored, rotating infusion fixation set that prevents the animal from tangling the tubing or blocking fluid flow. Ideal for fractious hospitalised patients.

- One base to attach to the cage equipped with double-sided tape and four holes to fix with screw.
- Two clasps that attach the infusion tubing to the base, allowing unlimited rotation.
- One 3 m length of sterile spiral PVC tubing with a Luer-Lock tip and a ring for attaching to the collar as needed.
- Perfuvet® Twist is easily attached to the cage; the base can be left on the cage and reused as often as necessary.
- The unlimited rotation prevents the animal from becoming tangled in the infusion set and blocking flow or requiring a time-consuming change of tubing.
- The spiral tubing allows ease of movement and prevents excessive pulling on the catheter.
- Saves time, improves safety of hospitalised animals, easy to use.
- Use on any size of animal (dogs, cats, rabbits...).

Supplied as a set (one fixed base, two half-clasps and three sterile single-use spiral tubing).

Watch the video version on our website !



Code	Model
157450	Set (one fixed base, two clasps and three sterile single-use spiral tubing)
157451	3 sterile single-use spiral tubing
157452	6 half-clasps

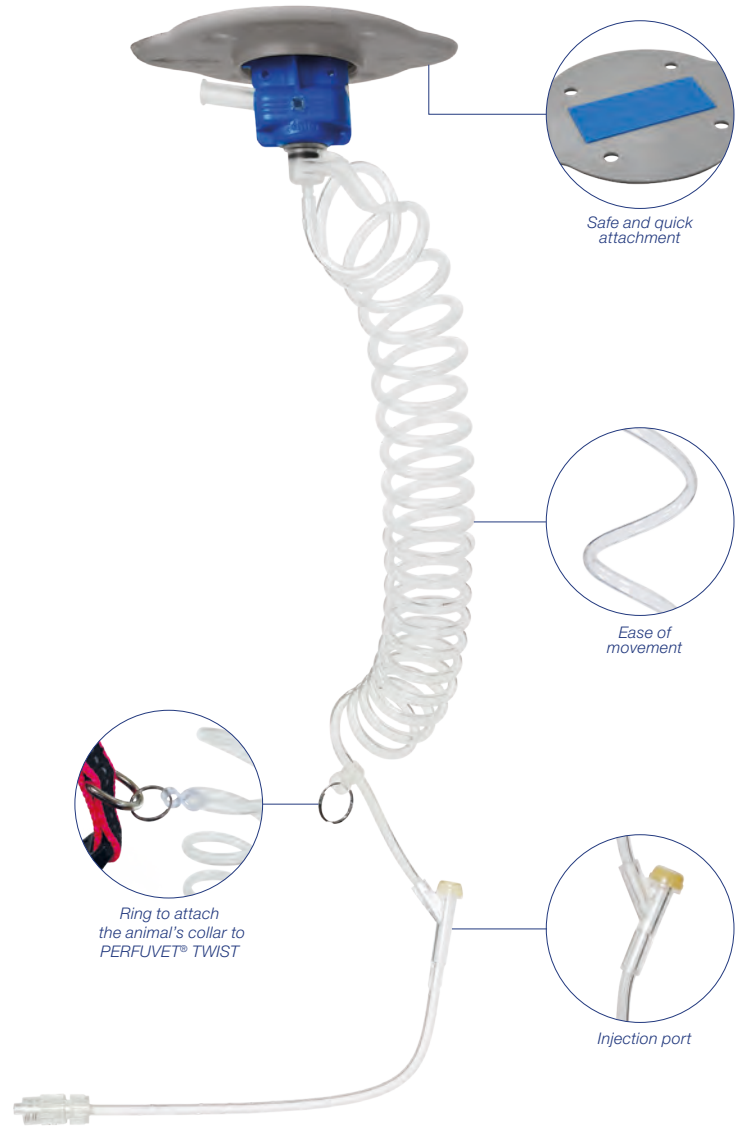
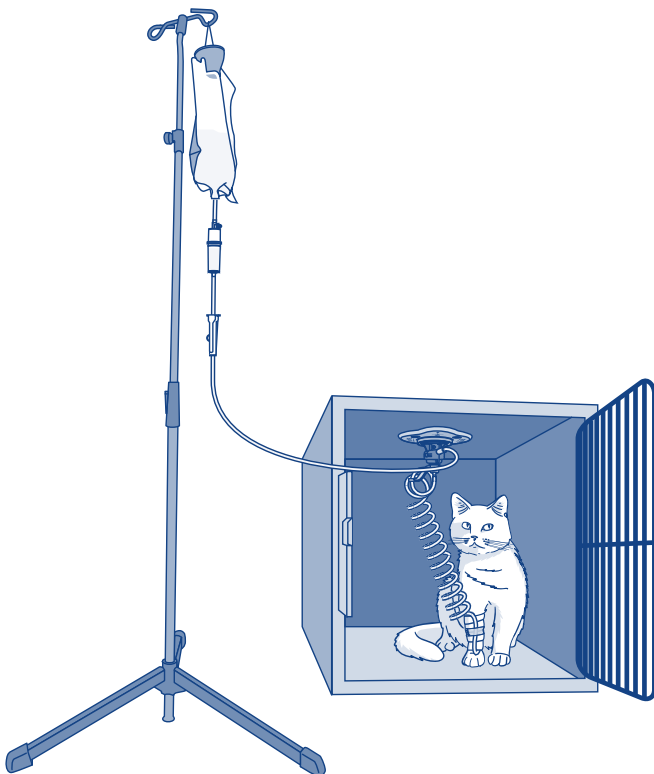

SAVE TIME | EASY TO USE | IMPROVES SAFETY OF HOSPITALISED ANIMALS



■ PERFUVET® SOFT

Extra long IV set for CALVES with an convenient and flexible drip chamber that is easy to prime.

- Precise flow control roller clamp.
- Calibration: **20 drops/mL**.
- For animals over 5 kg.
- Extra-long **250 cm** PVC tubing, very resistant, allowing you to dip part of it in a bucket of warm water to warm the infusion during IV administration.
- Two injection ports at 25 cm and 95 cm from the Luer-Lock connector.
- Convenient clear and flexible drip chamber, designed for fast priming.
- Sharp spike to ensure easy piercing of any bottle.
- Closable venting.
- Mobile Luer-Lock connector with protective cap.
- Slide clamp fitted.

Supplied individually sterile wrapped in boxes of 12.

Code x 12	Model
157393	Perfuvet® Soft

Outer packaging:
master case of 16 boxes

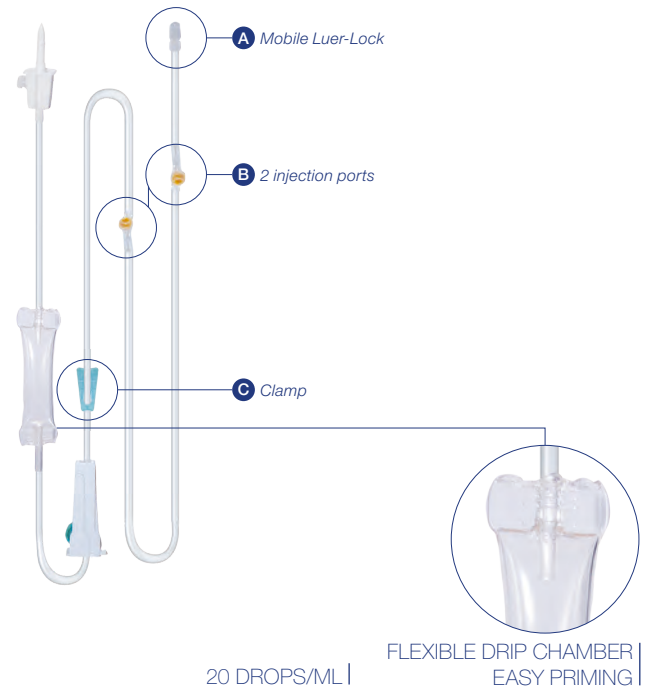

■ PERFUVET® LARGE

NEW

Extra long IV set for large animals with large flow. Large capacity, convenient and flexible drip chamber that is easy to prime. Ideal for boluses.

- Precise flow control roller clamp.
- Calibration: **20 drops/mL**.
- For animals over 5 kg.
- Extra-long and very resistant **230 cm** PVC tube.
- Convenient clear and flexible large capacity (30 mL) drip chamber, designed for fast priming.
- Sharp spike to ensure easy piercing of any bottle.
- Closable venting.
- Mobile Luer-Lock connector with protective cap.
- Slide clamp fitted.

Supplied individually sterile wrapped in boxes of 12.

Code x 12	Model
157398	Perfuvet® Micro

Outer packaging:
master case of 6 boxes

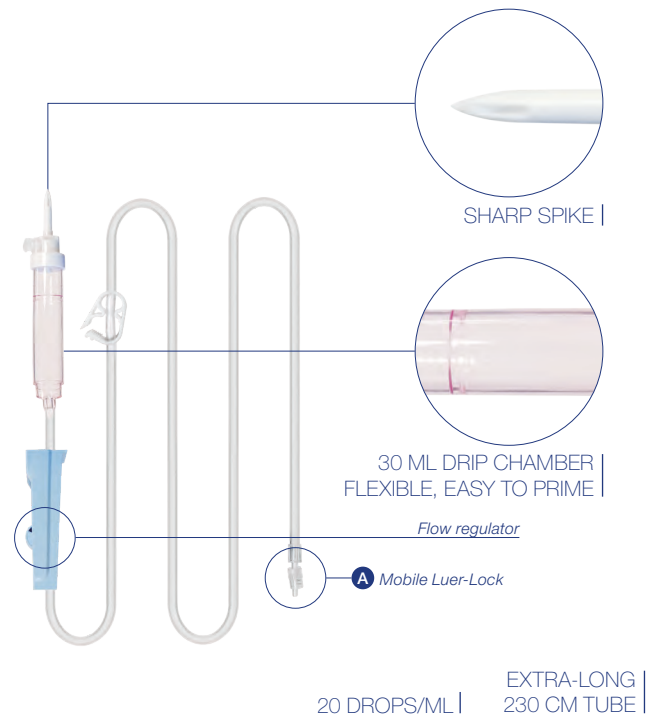

MOBILE LUER-LOCK

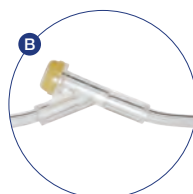

INJECTION PORT

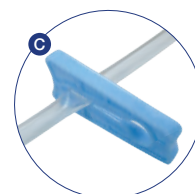

CLAMP



IMOMÉTAL

Metal large volumes intravenous injection set with:

- Double needle for air intake.
- Top collar.
- 150 cm clear PVC tubing.

Supplied individually in non-sterile polyethylene bag.

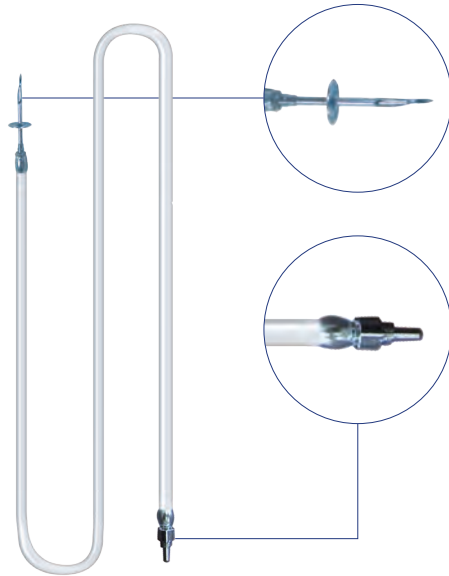

Code	Model
140512	Imometal

Outer packaging:
master case of 48 boxes

IMOPLAST

Plastic disposable large volumes intravenous injection set with double needle.

- With a closable venting for flexi-packs or hard bottles.
- 150 cm clear PVC tubing.
- Plastic Luer-Record hub.

Supplied in non-sterile polyethylene bag by 25.

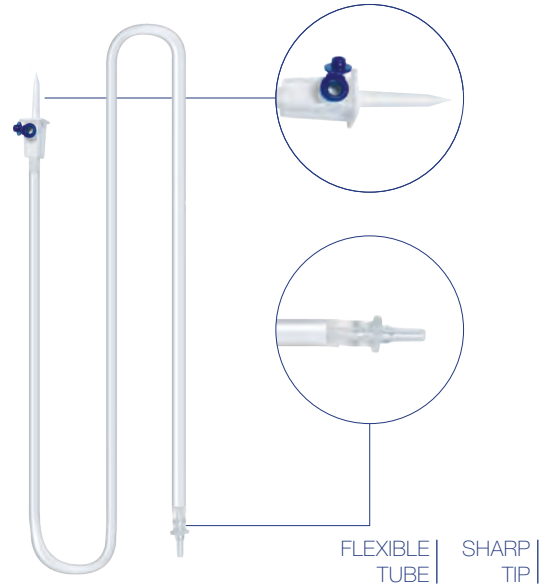

Code x 25	Model
140514	Complete with plastic Luer-Record hub
140515	Double needle only

IMOVALVE

Large volume intravenous set. The rubber dome fits all standard bottles and contains a built-in air intake.

Supplied in polyethylene bag with 150 cm tubing.

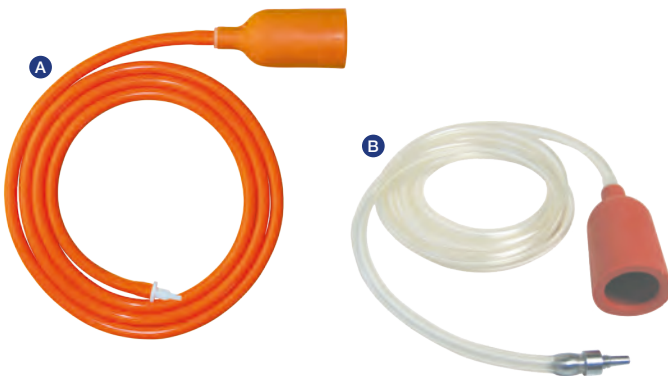

	Code	Model
A	140481	Complete set with plastic Luer-Record hub
	140483	Complete set with metal Luer hub
B	140500	Complete set with metal hub
	140501	Complete set with plastic hub
	140502	Dome only with reducer
	140533	1 meter of 4/7 tubing
	109332	1 meter 4/7 transparent tubing

K-STAR®

Infusion tubing anti-pinch device for PERFUVET® range.

- Prevents pinching of infusion tubing.
- Limits the risk of kinking the infusion tubing.
- Helps to secure the catheter.
- Can be used in any position.
- Quick to set up.
- Adaptable: can be used with 4 or 5 branches depending of the situation.
- Can be used on standard tubings for small animals (maximum diameter 4 mm).
- Size: 3 x 3 cm.

Supplied in packages of 50 or 100 pieces.

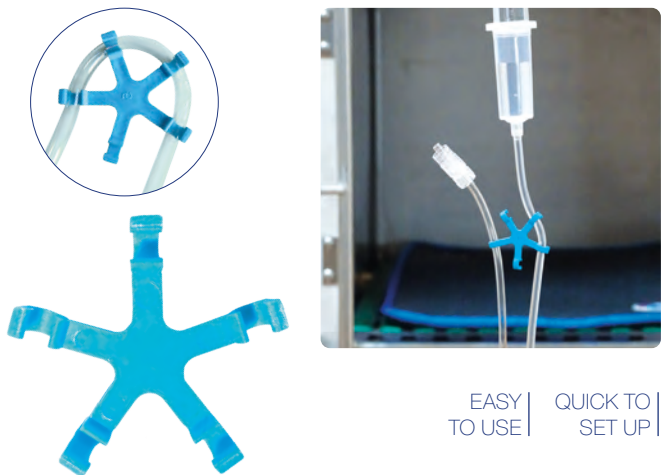

Code	Model	Pack.
191052	K-Star® - Anti-pinch device	x 50
191054	K-Star® - Anti-pinch device	x 100

FLUIDOTHERAPY SET

Fluidotherapy set including:

- A 5 liter tank with 4 holes to hang it and a pair of shoulder straps **A + B**.
- IMOFU system **C**: a drip chamber, a 20 cm 7/11 junction tube, a flow adjustment clamp **D**, 1.50 m of 4/7 clear tubing and a mixed plastic Luer-Record hub **E**.
- Fill through the cap.

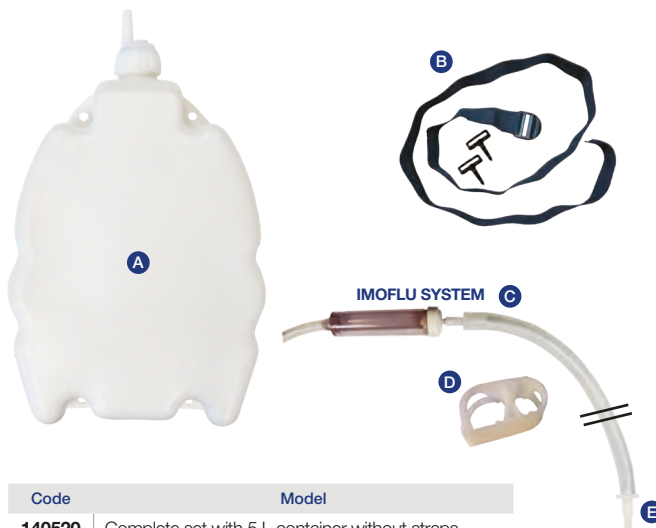

Code	Model
140520	Complete set with 5 L container without straps
140521	Complete set without tank (Imoflu)
D 140524	Clamp only
A 187010	5 L tank + cap, without shoulder straps
B 187011	Shoulder straps (pair) 2.5 and 5 L

DOUBLE NEEDLE

Double transfer needle to mix powder and liquids under vacuum.



Code	Model
140535	Transfer needle in bulk
140536	Sterile transfer needle on demand

MALE CAP

Male Luer-Lock cap with perforated membrane that fits on any female Luer-Lock hub.

Supplied in boxes of 12.



Code x 12	Model
157330	Male cap



UROLENE® CAT

Sterile cat urinary catheters, DEHP-free.

- Luer-lock hub with perforated and rotating collar to fix the catheter.
- Colour-coded according to size.
- Latex-free and DEHP free.
- Two end types:
 - Closed atraumatic rounded end with two side holes.
 - Open atraumatic end: facilitates removal of plug in the urethra, faster catheterisation.
- Stylet very easy to put back in place, does not move in the hub (closed end available with or without stylet).

Supplied individually sterilely wrapped in boxes of 12.

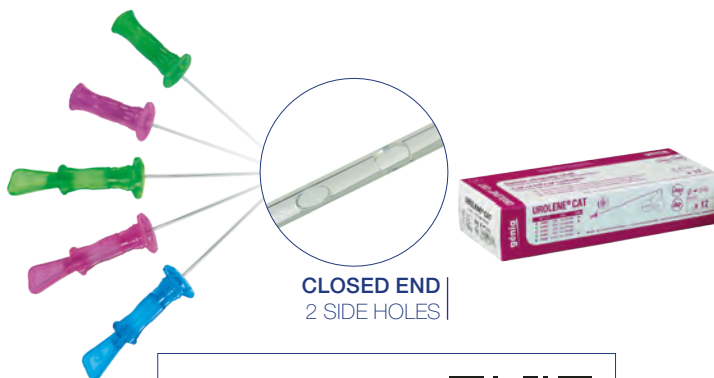

CLOSED END
2 SIDE HOLES

Watch the video version
on our website!

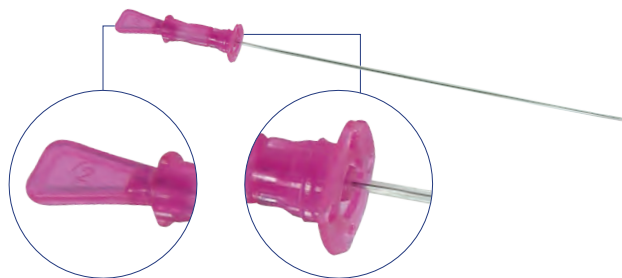

STYLET EASY TO
PUT IN PLACE

ROTATING PERFORATED
COLLAR

Code x 12 Closed end	Code x 12 Open end	Model	Dimensions
306898	-	With stylet	2.5 FG 0.8 x 110 mm
306900	306940	With stylet	3 FG 1.0 x 110 mm
306902	306942	With stylet	4 FG 1.3 x 140 mm
306904	-	Without stylet	3 FG 1.0 x 110 mm
306908	-	Without stylet	4 FG 1.3 x 140 mm



OPEN END
EASIER TO REMOVE

Watch the video version
on our website!



UROLENE® DOG

Sterile dog urinary catheters, DEHP-free.

- Blunt, atraumatic closed end with two side holes.
- Luer-Lock hub.
- Colour-coded according to size.
- Without stylet.
- Available in 5 sizes.

Supplied individually sterilely wrapped in boxes of 12.

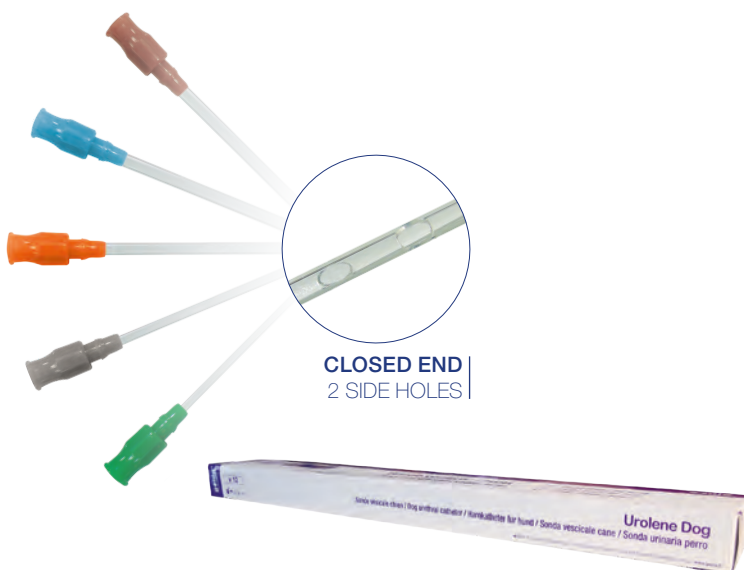
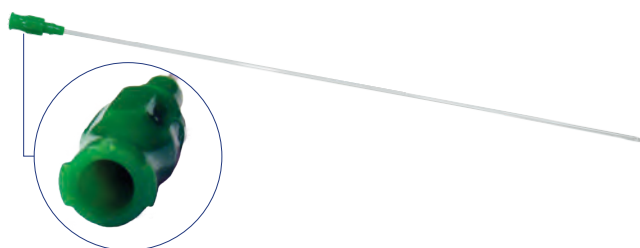

CLOSED END
2 SIDE HOLES

Code x 12 Closed end	Model	Dimensions
306920	Without stylet	4 FG 1,3 x 300 mm
306922	Without stylet	5 FG 1,7 x 350 mm
306924	Without stylet	6 FG 2,0 x 450 mm
306926	Without stylet	8 FG 2,6 x 500 mm
306928	Without stylet	10 FG 3,3 x 600 mm



■ STAINLESS STEEL BLADDER AND UTERINE CATHETERS

Stainless steel bladder and uterine catheters for large animals and pets.

- Blunt, closed ends with two deburred side holes.
- Luer-Lock hubs.

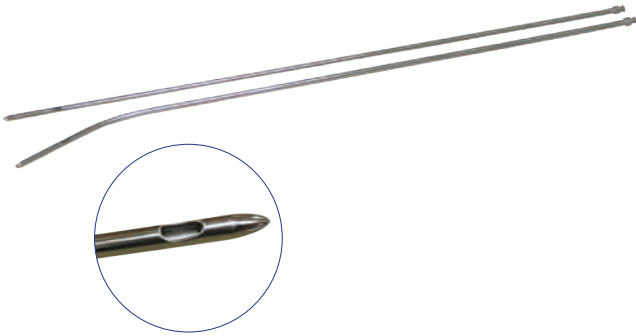

Code	Model	Length	Outside diameter
307126	Straight (cat)	170 mm	1 mm
307120	Curved (dog)	180 mm	2 mm
307122	Curved (dog)	250 mm	2.5 mm
307124	Curved (dog)	300 mm	3 mm
307110	Straight (large animals)	540 mm	5 mm
307112	Curved (large animals)	540 mm	5 mm

■ PVC BLADDER CATHETERS

PVC bladder catheters for female dogs.

- Blunt, closed ends with two side holes.
- Luer hub.
- Individual sterile packaging.

Supplied in packages of 10.



Code x 10	Model	Size	Outside diameter	French
317102	Curved	180 mm	2.0 mm	6
317104	Curved	180 mm	2.6 mm	8
317106	Curved	180 mm	3.3 mm	10

Outer packaging:
bag of 50



UROLITHIASIS CATHETERS

Urolithiasis catheters for ultrasonic scalers with stainless steel ball tip.
For SATELEC or EMS devices.

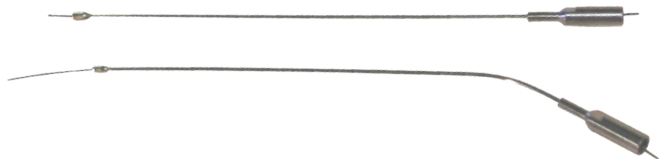

Code	Model	Length	Side
307130	EMS for dog	155 mm	Straight
307132	EMS for cat	115 mm	Curved
307133	SATELEC for dog	155 mm	Straight
307134	SATELEC for cat	115 mm	Curved

TUBING FOR CATHETERS

Plexiglas tubing with 2 caps for store the catheters and disinfect them with an appropriate product.
On demand: other lengths available.



Code	Length	Inside diameter	Outside diameter
300015	1 m	26 mm	30 mm

LACRIMAL CATHETERS

Stainless steel lacrimal catheters for small animals.
• Open, blunt end.
• Luer-Lock hub.
Supplied by 12.



Code x 12	Model	Length	Outside diameter
307102	Straight	10 mm	6/10 mm
307104	Curved	15 mm	7/10 mm

INTUBATION CATHETERS WITH BALLOON

Intubation catheters with balloon.
Supplied individually sterile wrapped in boxes of 10.

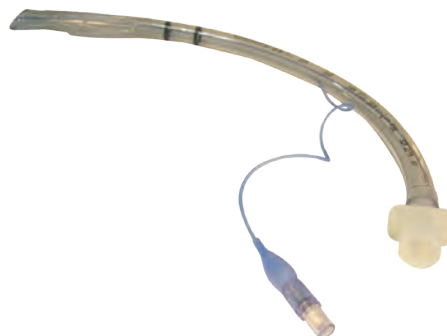

Code x 10	Size	Inside diameter	Outside diameter
307320	300 mm	5 mm	6.9 mm
307322	300 mm	6 mm	8.2 mm
307324	300 mm	7 mm	9.3 mm
307326	300 mm	8 mm	10.9 mm
307328	300 mm	9 mm	12.0 mm
307330	300 mm	10 mm	13.3 mm



SURGERY

Suture materials

Absorbable sutures	38
Non-absorbable sutures	40
Suture needles	43

Surgical instruments

Scalpel	44
Surgical scissors	46
Various scissors	48
Needle holders	49
Dissecting forceps	50
Haemostatic forceps	51
Various	52

Surgical equipment

Surgical drapes	54
Displaced abomasum treatment	55
Prolapse prevention and Caesarean	56

Watch the video
“Best practices for use and storage of our sutures in dispensers”
 on our Youtube channel !



p 41 Read about our Cleanroom

FASTFIL®

Synthetic rapidly absorbable monofilament suture. Purple.
 Composition: poly(glycolide-co-caprolactone) (PGCL).

- Ethylene oxide sterilisation.
- Tolerance: excellent, no wicking effect.
- Smoothness: excellent.
- Flexibility: minimal memory.
- Knot security: good.
- Loss of tensile strength: **7 days** (55%).
- Complete absorption by hydrolysis: **80 to 120 days**.
- Lasts under storage.
- Indications: ideal for rapid healing of tissues with limited tension (uterus).
- Packaging: vacuum-sealed in an aluminium bag in a cardboard box.
- Expiration: 2 years if stored in its original packaging, **1 month once opened**. Store in a cool, dry place.

Supplied individually.

DISPENSER CASE

EP	USP	Code 15 m	Code 25 m	Code 50 m
4	1	-	343014	343015
5	2	343016	343018	343020

MONOFIL

Synthetic absorbable monofilament suture, purple.
 Composition: polydioxanone (PDO).

- Sterilised with ethylene oxide.
- Tolerance: excellent, no wicking effect.
- Smoothness: excellent.
- Flexibility: minimal memory.
- Minimal sawing effect.
- Knot security: good.
- Loss of tensile strength: **30 days** (75%).
- Complete absorption by hydrolysis: **180 to 240 days**.
- Lasts under storage.
- Indications: soft tissues, uterus and hollow organs. Infected or slow-healing tissues.
- Packaging: vacuum-sealed in an aluminium bag in a cardboard box.
- Expiration: 3 years if stored in its original packaging, **4 months once opened**. Store in a cool, dry place.

Dispenser case: supplied individually.
 5 m spool: supplied by 12.

DISPENSER CASE

EP	USP	Code 15 m	Code 25 m	Code 50 m	Code 75 m
1.5	4/0	340902	340903	-	-
2	3/0	340904	340905	-	-
3	2/0	340906	340907	-	-
3.5	0	340908	340909	-	-
4	1	340910	340911	340918	340919
5	2	340900	340901	340912	340922
6	3-4	340913	340914	340916	-

5 M SPOOL

EP	USP	Code 5 m	Pack.
5	2	340990	x 12
6	3-4	340991	x 12

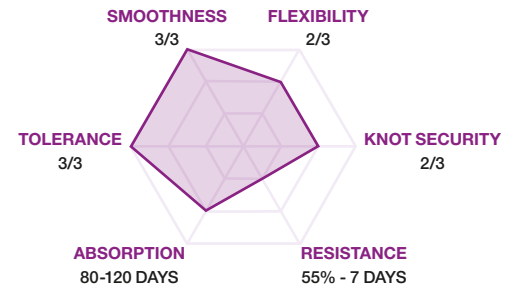

VERY RAPID | ABSORPTION

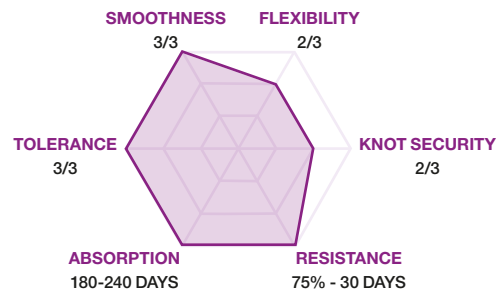

EASY TO | HANDLE



LACFIL

- Synthetic absorbable **BRAIDED** suture, purple.
Composition: PGLA - polyglycolic acid (90%) and lactic acid (10%) copolymer.
Coating: PGLA and calcium stearate.
- Sterilised with ethylene oxide.
 - Tolerance: excellent.
 - Smoothness: very easy passage, coating minimises sawing effect.
 - Flexibility: very easy to work with and easy to knot.
 - Knot security: excellent.
 - Loss of tensile strength: **21 days** (50%).
 - Absorption by hydrolysis in **60 to 80 days**.
 - Lasts under storage.
 - Indications: versatile suture (uterus, muscles, skin).
 - Packaging: vacuum-sealed in an aluminium bag in a cardboard box.
 - Expiration: 3 years if stored in its original packaging, **4 months once opened**. Store in a cool, dry place.

Supplied individually.

DISPENSER CASE

EP	USP	Code 15 m	Code 25 m	Code 50 m
2	3/0	342000	342001	-
3	2/0	342002	342003	-
3.5	0	342004	342006	-
4	1	342008	342009	-
5	2	342010	342012	342014
6	3-4	342016	342018	342020
7	5	342022	342024	342026
8	6	342028	342030	342032

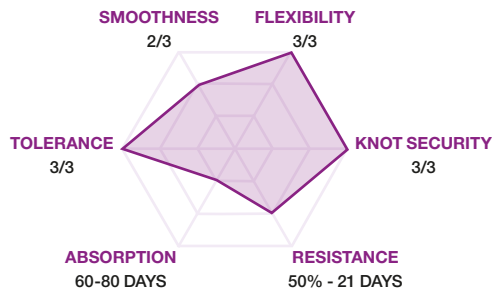

EXCELLENT TOLERANCE

GLYCOFIL®

- Synthetic absorbable **BRAIDED** suture, purple.
Composition: polyglycolic acid (PGA).
Coating: polycaprolactone and calcium stearate.
- Sterilised with ethylene oxide.
 - Tolerance: good.
 - Smoothness: good.
 - Flexibility: excellent.
 - Knot security: excellent.
 - Loss of tensile strength: **21 days** (50%).
 - Absorption by hydrolysis in **60 to 90 days**.
 - Lasts under storage.
 - Indications: very resistant, perfect for muscles.
 - Packaging: vacuum-sealed in an aluminium bag in a cardboard box.
 - Expiration: 3 years if stored in its original packaging, **4 months once opened**. Store in a cool, dry place.

Dispenser case: supplied individually.
 5 m spool: supplied by 12.

DISPENSER CASE

EP	USP	Code 15 m	Code 25 m	Code 50 m	Code 75 m	Code 100 m
2	3/0	340810	340811	-	-	-
3	2/0	340812	340813	-	-	-
3.5	0	340814	340815	-	-	-
4	1	340816	340817	340836	-	-
5	2	340818	340820	340822	340838	340839
6	3-4	340824	340826	340827	340840	-
7	5	340834	340828	340829	-	-
8	6	340831	340830	340832	-	-

5 M SPOOL

EP	USP	Code 5 m	Pack.
5	2	340890	x 12
6	3-4	340891	x 12
7	5	340892	x 12
8	6	340893	x 12

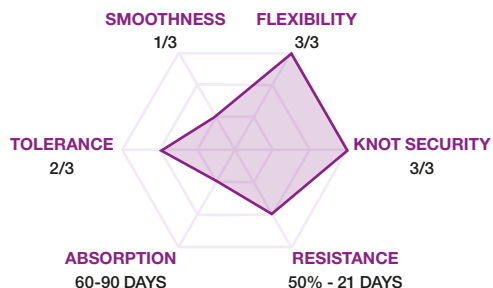

VERY RESISTANT

FILSILK

Strong and flexible braided silk suture with low wicking. Black.

- Sterilised with ethylene oxide.
- Packaging: in a sterilisation bag and a cardboard box.
- Expiration: 5 years if stored in its original packaging. Store in a cool, dry place.

Supplied individually.



EP	USP	Code	Length
9	7	340500	45 m
8	6	340502	55 m
7	5	340504	70 m
6	3-4	340506	90 m
5	2	340508	100 m
4	1	340510	100 m
3.5	0	340512	100 m
3	2/0	340514	100 m

FILAMID

Braided, coated polyamide suture. Black.

- Sterilised with ethylene oxide.
- Packaging: in a sterilisation bag and a cardboard box.
- Expiration: 5 years if stored in its original packaging. Store in a cool, dry place.

Supplied individually.



EP	USP	Code	Length
9	7	340552	40 m
8	6	340554	50 m
7	5	340556	60 m
6	3-4	340558	70 m
5	2	340560	100 m
4	1	340562	100 m
3.5	0	340564	100 m
3	2/0	340566	100 m
2.5	2/0	340568	100 m
2	3/0	340570	100 m

FILINE

Flexible, natural linen suture. Beige.

- Sterilised with ethylene oxide.
- Packaging: in a sterilisation bag and a cardboard box.
- Expiration: 5 years if stored in its original packaging. Store in a cool, dry place.

Supplied individually.



EP	USP	Code	Length
6	3-4	340604	50 m
5	2	340606	75 m
4	1	340608	100 m
3	2/0	340612	100 m

FILESTER

Braided polyester suture. White.

- Sterilised with ethylene oxide.
- Packaging: in a sterilisation bag and a cardboard box.
- Expiration: 5 years if stored in its original packaging. Store in a cool, dry place.

Supplied individually.



EP	USP	Code	Length
9	7	340652	40 m
8	6	340654	45 m
7	5	340656	65 m
6	3-4	340658	90 m
5	2	340660	100 m
4	1	340662	100 m
3.5	0	340664	100 m

p.43 [Find suture needles](#)

SUTURE RACK

Suture rack for 3 Génia dispenser cases. May be stacked side-by-side.



CAN BE CONNECTED

Code	Model
340480	Suture rack

REMINDER:

EP - European Pharmacopoeia unit for suture diameter: 1/10 mm. From thinnest to thickest: 1,5 < 9.

USP - United States Pharmacopoeia unit for resistance: number of 0's. From thinnest to thickest: 4/0 < 0 < 7.



CLEANROOM

DESIGN AND QUALITY OF THE SUTURES

Génia masters each step of the manufacturing process of sutures, from raw materials to finished, ETO-sterilised products.

Our cleanroom is ISO 8-certified according to the standard NF EN 14644-1.



Our internal laboratory allows us to conduct lot testing of sterilisation and to validate and certify the chemical and physical conformity of our products to the standards of the European Pharmacopoeia.

Our cleanroom is validated and certified every year by an independent and authorised quality control organisation.

SUTURE CONSERVATION

Our sutures are packed within several layers of protection to guarantee optimal preservation:

1) REEL DISPENSER

The sterile thread is contained in a dispenser designed to provide maximum security during use, and specifically intended for the practicing conditions of veterinary medicine. Génia dispensers have a hermetic safety cover and thick, impermeable walls to maintain minimum air humidity for proper preservation of the thread. Conceived to accompany the vet in all of their interventions, their compact design lets you slide them into your pocket, and store them easily in the car.

2) ALUMINIUM SACHET

The dispensers are packaged in sachets made of an aluminium alloy specially designed to increase the storage life of sutures. The dispensers are vacuum-packed in the aluminium sachets to guarantee an optimal barrier to air humidity.

3) CARDBOARD PACKAGING

The aluminium sachet is then packed into a cardboard package to protect it during transport and storage before use.

DISPENSER CASES

Outer packaging: sterilisation bag and a cardboard box.

WATERPROOF SAFETY COVER

The suture stays dry, even if the cover is open.

COMPACT

Pocket-sized, No sharp angle.

REEL

Adapted to the suture. Allows you to decrease the suture memory (Fastfil, Monofil and some Lacfil).

THICK AND WATERPROOF

Reinforced, minimal moisture.



ABSORBABLE SUTURES

The dispensers, after packaging in a peel-off sterile sheath, are then packaged in an aluminium sachet which guarantees minimum humidity.

If the sachet is not under vacuum, it does not guarantee the humidity barrier.



VACUUM INTACT - USE



PUNCTURED - DO NOT USE

Cautions for use:

- Our sutures are classified for **veterinary use** and can be handled with surgically sterile instruments.



- Provided that it is under vacuum, the aluminium sachet guarantees that thread is sterile. **Do not use the thread if the aluminium sachet is inflated.** If the sachet has just been damaged, the thread must be used immediately.

- Do not re-sterilise after opening the sachet.



- Store away from sunlight, in a dry place at a temperature lower than 25°C. Do not use the thread if there are traces of moisture inside the reel.

- Remember to properly close the cap after using the thread. If the dispenser is dirty, clean it with a wipe soaked in alcohol.



Opening date

/ /



- Respect the expiry date and the maximum period of use after opening indicated on the packaging. Write the opening date of the thread on the label provided on the reel for this purpose.

Watch the video version on our Youtube channel !



p.38 Find sutures



SUTURE NEEDLES SELECTION GUIDE

SUTUREC NEEDLES

SCALE 1:1

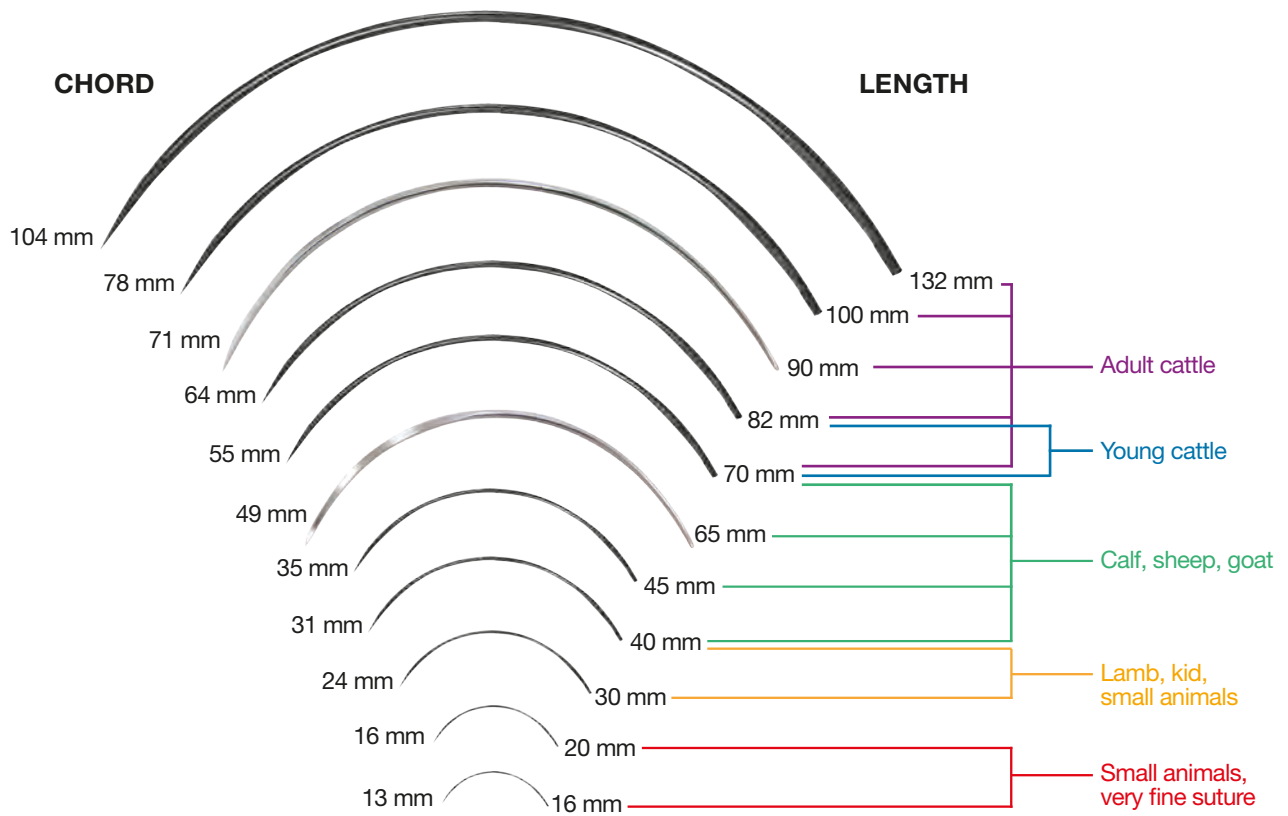

REMINDERS



Triangular needle cross-section: to be used for skin, muscle, fascia.

Reverse cutting : a triangular needle with the cutting edge facing outwards (reverse cutting) causes less tissue injury than a needle with the cutting edge facing inwards. It is the first choice to penetrate firm, solid tissues such as fasciae, cartilage, fibrous tissues...



Round needle cross-section: to be used for hollow organs, blood vessels.



Regular eye

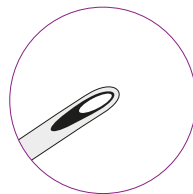

Spring eye

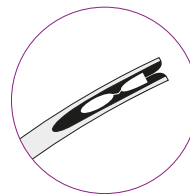

Coubure : Curvature is expressed as eighths of a circle. In principle, the deeper the plane, the more curved the needle should be.

1/2 C

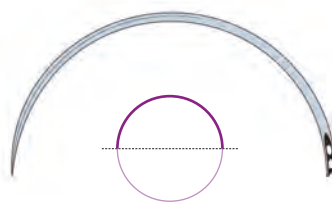

3/8 C

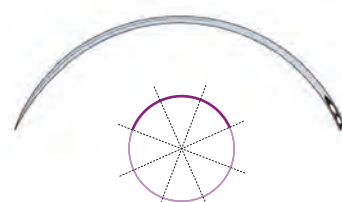

POST-MORTEM NEEDLES

Curved, triangular suture needles with regular eye.
Supplied in boxes of 12.

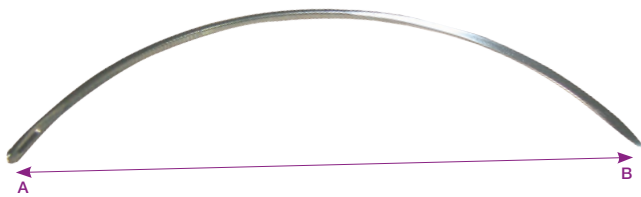

Code x 12	Length	Chord (Distance A-B)
147690	94 mm	74 mm
147691	126 mm	99 mm
147692	150 mm	118 mm

SERPENTINE NEEDLES

Stainless steel serpentine suture needles with regular eye.
Supplied in boxes of 12.



Code x 12	Length	Chord (Distance A-B)
147685	150 mm	140 mm

SUTUREC NEEDLES

Stainless steel suture needles, curved, 3/8 circle.
Supplied in boxes of 12.

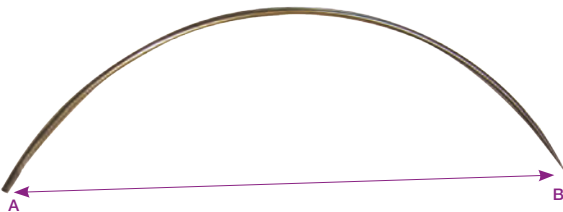

Code x 12 Spring	Code x 12 Regular	Length	Chord (Distance A-B)	Point type
157746	-	16 mm	13 mm	Round
157745	-	20 mm	16 mm	Round
157744	-	30 mm	24 mm	Round
157743	157713	40 mm	31 mm	Round
157742	157712	45 mm	35 mm	Round
157741	157711	70 mm	55 mm	Round
157740	157710	90 mm	71 mm	Round
-	157708	132 mm	104 mm	Round
157728	-	82 mm	64 mm	Triangular
157727	-	16 mm	13 mm	Triangular
157726	-	20 mm	16 mm	Triangular
157725	-	30 mm	24 mm	Triangular
157724	157696	40 mm	31 mm	Triangular
157723	157704	45 mm	35 mm	Triangular
157722	157701	70 mm	55 mm	Triangular
-	157703	90 mm	72 mm	Triangular
-	157702	90 mm	70 mm	Triangular
157721	-	92 mm	72 mm	Triangular
157720	157700	100 mm	78 mm	Triangular
-	157698	130 mm	102 mm	Triangular

SUTUREC NEEDLES EXTRA FINE EF

Stainless steel suture needles, curved, 3/8 circle.
Regular large eye and extra fine triangular point.
Supplied in boxes of 12.

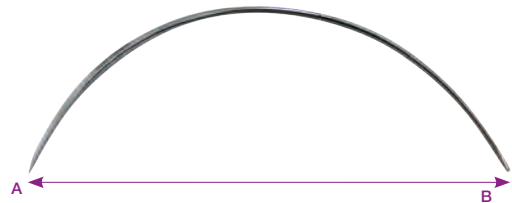

Code x 12	Length	Chord (Distance A-B)	Point type	Eye type
157760	65 mm	49 mm	Triangular	Regular
157761	90 mm	71 mm	Triangular	Regular

SUTUREC NEEDLES EXTRA FINE EF2/EF3

Stainless steel REVERSE CUTTING suture needles, curved, 3/8 circle. Large eye, extra fine triangular point.
Supplied in boxes of 12.



Code x 12	Length	Chord (Distance A-B)	Point type	Eye type	Model
157764	65 mm	49 mm	Triangular	Regular	EF2
157766	90 mm	71 mm	Triangular	Regular	EF3

BONNEY'S NEEDLES

Stainless steel suture needles, curved, triangular with regular eye.
Supplied in boxes of 12.

Code x 12	Length	Chord (Distance A-B)
147670	33 mm	26 mm
147665	46 mm	36 mm
147660	61 mm	48 mm
147655	80 mm	63 mm
147650	93 mm	73 mm

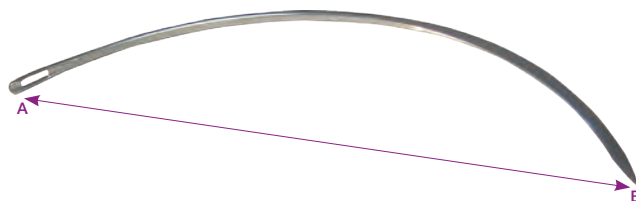

■ SCALPEL HANDLE

Code	Model
307950	Scalpel handle n°3
307952	Scalpel handle n°4
307970	Folding scalpel handle n°4

SCALPEL BLADE COMPATIBILITY

Handle n°3	Handle n°4
n°10	n°19
n°11	n°20
n°12	n°21
n°15	n°22
-	n°23
-	n°24



■ SWANN MORTON SURGICAL SCALPEL BLADES

Carbon steel scalpel blades.

Supplied in boxes of 100 (sterile blades: individually sterilely wrapped, non-sterile blades: 20 packets of 5 blades).

NON-STERILE

Code x 100	Model
307943	Scalpel blades n° 10
307963	Scalpel blades n° 22
307949	Scalpel blades n° 23
307944	Scalpel blades n° 24

STERILE

Code x 100	Model
307965	Scalpel blades n° 22
307956	Scalpel blades n° 23



SCISSORS

Our scissors are made of stainless steel. Our production facility has been ISO 9001-certified since 2007 in full compliance with the control and traceability requirements for health products.

OUR FINISHES



SURGICAL (Stainless steel)

These items are made exclusively from surgical stainless steel, as required for surgical instruments. Our production is intended for routinely used instruments.

CRYOCUT - GOLD RINGS (Stainless steel with satin matte finish)

This line of scissors was designed for intensive veterinary use. Cryosectioning is obtained by thermal overhardening for a reinforced cutting edge.

UPSTYLE - BLACK RINGS (Stainless steel with satin matte finish)

Features:

- Blanks selected according to stricter criteria.
- Slimmer profiles to make them lighter, easier to handle and better suited to delicate procedures.
- Thermal hardening for a reinforced cutting edge.
- Inspections and testing; finishing done under magnifying glass.

UPCUT - BLACK RINGS (Stainless steel with satin matte finish)

Same quality as the UPSTYLE models. The UPCUT scissors have one micro-serrated blade that stops the scissors from slipping and one razor blade to ensure a clean cut.

UPCUT

The precision of the cut is ensured by:

- the serrated lower blade that holds the tissues.
- the fine upper razor blade.

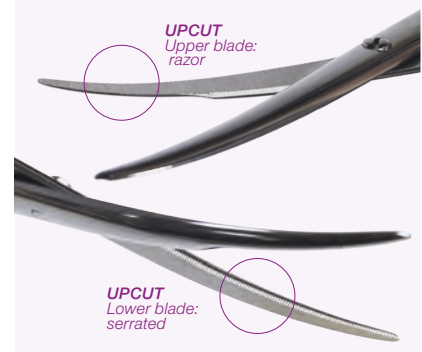

UPCUT
QUALITY

CUSTOMER SERVICE

Sharp instruments become dull and worn with use. This is why Génia, a leader in the field, provides a maintenance service to repair and sharpen all types of instruments:

SHARPENING SERVICE

We have a qualified production unit capable of sharpening and reconditioning all cutting instruments:

- Scissors of all kinds (medical, styling, grooming...),
- All surgical instruments (forceps, retractors...),
- Cutting heads for small and large animals clippers,
- Farrier drawing knives, etc.

REPAIR SERVICE

We can also repair and recondition:

- Scissors (micro-teeth, screw replacement, polishing...),
- All surgical instruments (forceps, retractors...),
- Electric clippers (cord, vibrating head...),
- YLG Tattooing machine (spring, tip...),
- Prods (adjusting...).

For all repairs, a quote will be provided.

If you need a specific repair, do not hesitate to contact us to identify the problem and to request a personalised estimate upon receipt of the equipment.

Your equipment will be reconditioned using genuine parts.

All our sharpenings are guaranteed for one week and all repairs are guaranteed for 3 months. We guarantee the repairs carried out but we do not cover problems that may occur in other parts of the device.



WE CAN REPAIR AND
SHARPEN, PLEASE ASK



MAYO SCISSORS

Stainless steel screw-type scissors with satin matte finish.



Code	Finish	Model	Length	Blades type
600303	Surgical	Curved	14 cm	Thin
600275	Surgical	Curved	14 cm	Rounded
A 600342	Surgical	Curved	14 cm	Rounded
600340	Surgical	Straight	14 cm	Rounded
600322	Upstyle	Curved	17 cm	Thin
600273	Surgical	Straight	17 cm	Rounded
B 600319	Upstyle	Straight	17 cm	Thin

MAYO STILLE SCISSORS

Stainless steel screw-type scissors with satin matte finish.

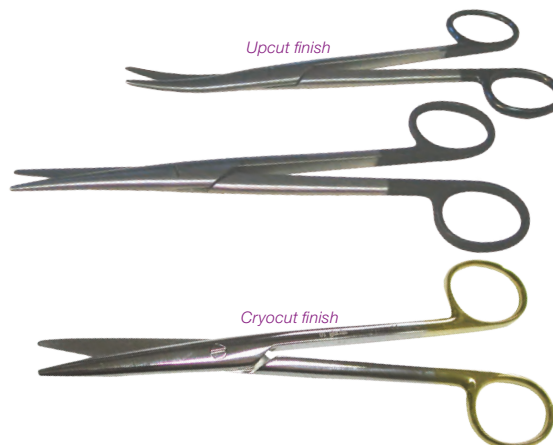

Code	Finish	Model	Length
600370	Surgical	Straight	15 cm
600375	Surgical	Curved	15 cm
600372	Surgical	Straight	17 cm
600377	Surgical	Curved	17 cm
600378	Surgical	Curved	20 cm
601420	Cryocut	Straight	15 cm
601423	Cryocut	Curved	15 cm
601422	Cryocut	Straight	17 cm
601424	Cryocut	Curved	17 cm
600410	Upcut	Straight	17 cm
600411	Upcut	Curved	17 cm
600400	Upstyle	Straight	15 cm
600402	Upstyle	Curved	15 cm
600401	Upstyle	Straight	17 cm

MAYO SERRATED SCISSORS

Stainless steel screw-type scissors with satin matte finish.

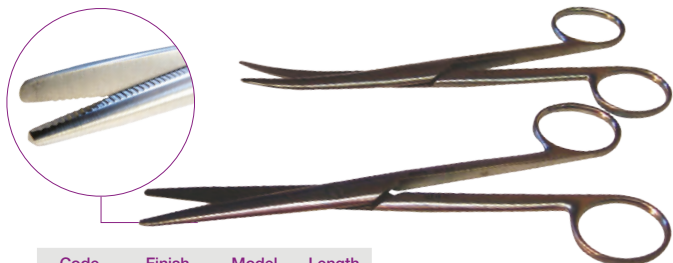

Code	Finish	Model	Length
601453	Surgical	Straight	15 cm
601454	Surgical	Curved	15 cm
601456	Surgical	Straight	17 cm
601458	Surgical	Curved	17 cm

METZENBAUM SCISSORS

Stainless steel screw-type scissors with satin matte finish.

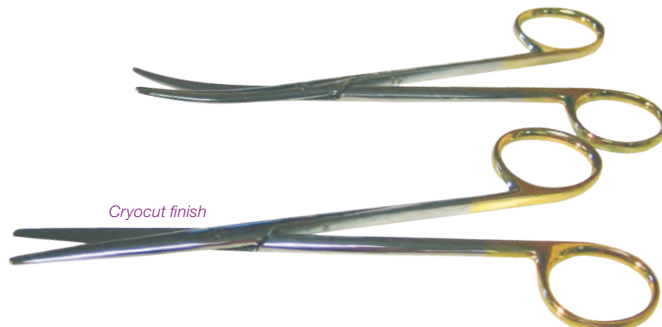

Code	Finish	Model	Length
600452	Surgical	Straight	15 cm
600458	Surgical	Curved	15 cm
600459	Surgical	Curved	16 cm
600460	Surgical	Curved	18 cm
600512	Surgical	Straight thin	18 cm
600515	Surgical	Curved thin	18 cm
601410	Cryocut	Straight	14 cm
601413	Cryocut	Curved	14 cm
601412	Cryocut	Straight	18 cm
601414	Cryocut	Curved	18 cm
600502	Upcut	Curved	14 cm
600505	Upcut	Straight	18 cm
600506	Upcut	Curved	18 cm
600490	Upstyle	Straight	14 cm
600493	Upstyle	Curved	14 cm
600494	Upstyle	Curved	18 cm
600530	Upstyle	Curved thin	18 cm
600495	Upstyle	Curved	20 cm

BROPHY SCISSORS

Stainless steel screw-type scissors with satin matte finish.

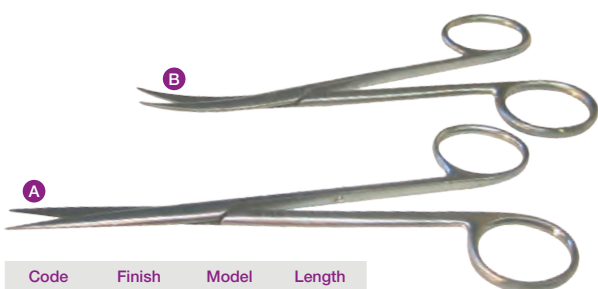

Code	Finish	Model	Length
A 600741	Surgical	Straight	14 cm
B 600743	Surgical	Curved	14 cm



■ ENUCLEATION SCISSORS

Stainless steel screw-type scissors with satin matte finish.



	Code	Finish	Model	Length
A	600886	Surgical	Curved	13 cm
B	600887	Surgical	Very curved	13 cm

■ IRIDECTOMY SCISSORS

Stainless steel screw-type scissors with satin matte finish.

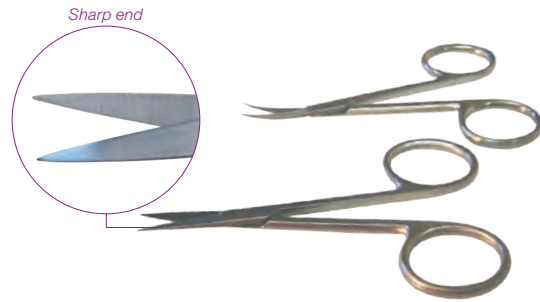

	Code	Finish	Model	Length
	600928	Surgical	Straight	10.5 cm
	600929	Surgical	Curved	10.5 cm
	600935	Upstyle	Straight	10.5 cm

■ STEVENS SCISSORS

Stainless steel screw-type scissors with satin matte finish.

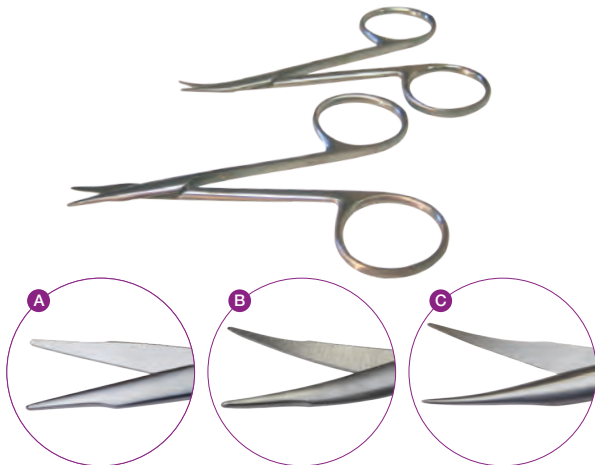

	Code	Finish	Model	Length
A	600810	Surgical	Straight short blade	11 cm
B	600812	Surgical	Curved short blade	11 cm
C	600827	Upstyle	Blunt curved	11 cm

■ STRABISMUS SCISSORS

Stainless steel screw-type scissors with satin matte finish.



	Code	Finish	Model	Length
A	600910	Surgical	Straight	11 cm
B	600911	Surgical	Curved	11 cm

■ SPENCER SCISSORS

Stainless steel screw-type scissors with satin matte finish.



	Code	Finish	Model	Length
	601255	Surgical	Straight	9 cm
	601258	Surgical	Curved	9 cm
	601256	Surgical	Straight	11 cm
	601259	Surgical	Curved	12 cm

■ FOMON SCISSORS

Stainless steel screw-type scissors with satin matte finish. These may be used with the right angle clamp (code 657052 p.51).



EXCELLENT FOR ENUCLEATION AND ROUND LIGAMENT OF THE FEMORAL HEAD SURGERY

	Code	Finish	Model	Length
	600777	Surgical	Very curved	14 cm

p.51 [Find the right angle clamp](#)



UNIVERSAL SCISSORS

Stainless steel standard quality scissors.



Code	Model	Length
307920	Serrated blades, plastic handles	18.5 cm

LISTER SCISSORS

Stainless steel screw-type scissors with satin matte finish.

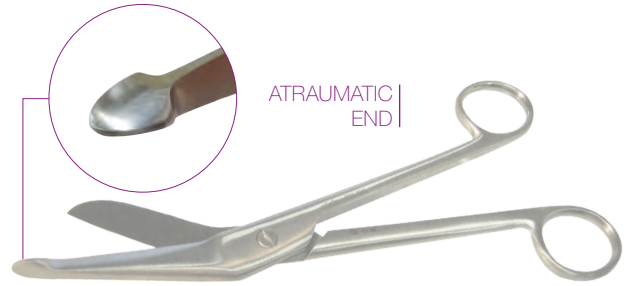

Code	Finish	Model	Length
601239	Surgical	Bent	18 cm

STANDARD SCISSORS

Chrome-plated carbon steel screw-type scissors.



Code	Finish	Model	Length
601313	Surgical	Straight pointed	18.5 cm

MEDICAL SCISSORS

Stainless steel screw-type scissors with satin matte finish.

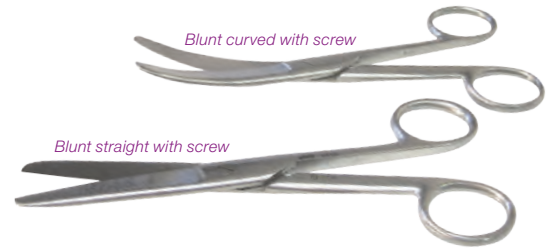

Code	Finish	Model	Length
600122	Surgical	Blunt blunt straight	14 cm
600202	Surgical	Sharp blunt straight	14 cm
600123	Surgical	Blunt blunt straight	16 cm
600129	Surgical	Blunt blunt curved	16 cm
600124	Surgical	Blunt blunt straight	18 cm
600130	Surgical	Blunt blunt curved	18 cm
600170	Surgical	Sharp curved	18 cm

[p 128 Find our cleaning and pre-disinfection products](#)

[p 128 Find our disinfection protocol](#)

FUR AND MANE SCISSORS

Chrome-plated carbon steel screw-type scissors.



Code	Finish	Model	Length
601470	Surgical	Curved	18 cm

[p.128 Find our cleaning and pre-disinfection products](#)

■ OLSEN HEGAR NEEDLE HOLDER

Stainless steel needle holder forceps with satin matte finish, surgical quality.

Integrated scissors

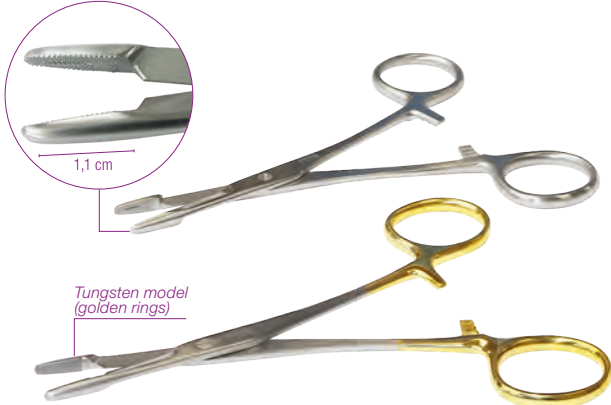

Tungsten model (golden rings)

Code	Model	Length
607024	Standard	14 cm
607028	Tungsten	14 cm
607030	Tungsten	18 cm

■ MAYO HEGAR NEEDLE HOLDER

Stainless steel needle holder forceps with satin matte finish, surgical quality.

- Thick bit.

Standard model

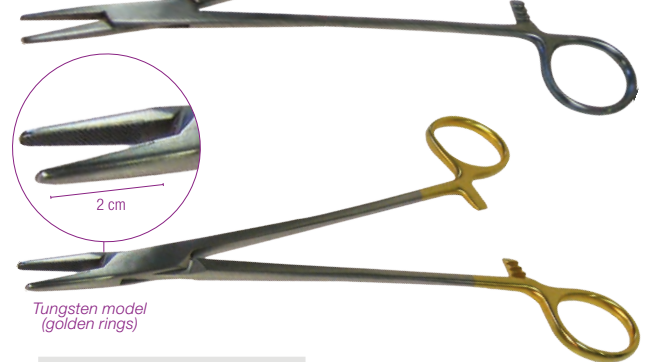

Tungsten model (golden rings)

Code	Model	Length
607003	Tungsten	14 cm
607000	Standard	15 cm
607002	Standard	18 cm
607006	Tungsten	18 cm

■ MATHIEU NEEDLE HOLDER

Stainless steel needle holder forceps with satin matte finish, surgical quality.

Standard model

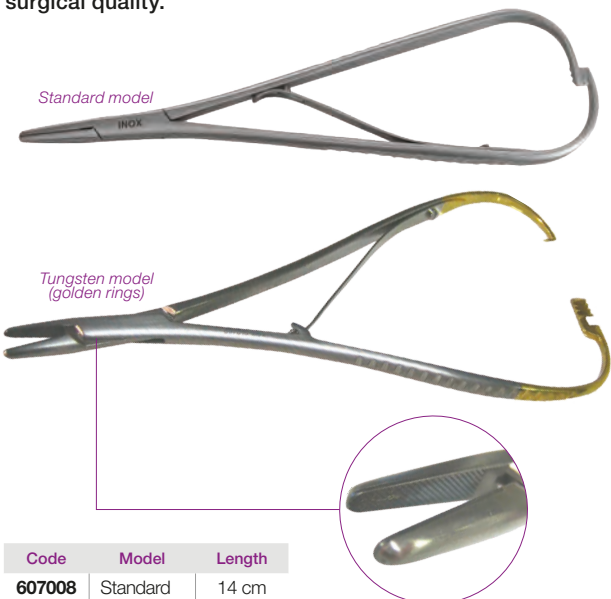

Tungsten model (golden rings)

Code	Model	Length
607008	Standard	14 cm
607014	Tungsten	14 cm
607010	Standard	17 cm
607016	Tungsten	17 cm
607018	Tungsten	20 cm

■ CRILE WOOD NEEDLE HOLDER

Stainless steel needle holder forceps with satin matte finish, surgical quality. Locking handles.

- Fine bit.



Code	Model	Length
607032	Straight	15 cm

■ BOYTON NEEDLE HOLDER

Stainless steel needle holder forceps with satin matte finish, surgical quality.

- Extra fine bit.



Code	Model	Length
607020	Standard	12.5 cm

■ GILLIES NEEDLE HOLDER

Stainless steel needle holder forceps with satin matte finish, surgical quality.



Code	Model	Length
607022	Standard	16 cm

TUNGSTEN PLATES CAN BE REPLACED | PLEASE ASK FOR DETAILS |

p 43 Find our suture needles



STANDARD FORCEPS

Stainless steel dissecting forceps with satin matte finish.

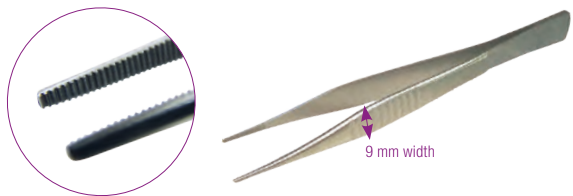

Code	Model	Length	Bit length
650001	Without teeth	12 cm	13 mm
650031	With teeth	12 cm	-
650012	Without teeth	14 cm	19 mm

ADSON FORCEPS

Stainless steel dissecting forceps with satin matte finish. Standard bit.

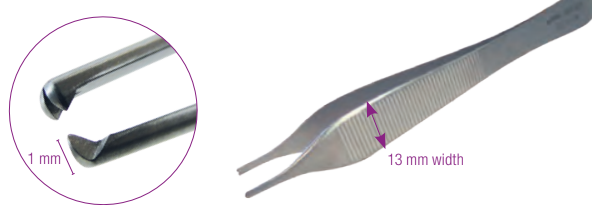

Code	Model	Length	Bit length
650320	Without teeth	12 cm	13 mm
650322	With teeth	12 cm	-

MICRO ADSON FORCEPS

Stainless steel dissecting forceps with satin matte finish. Extra fine bit.



Code	Model	Length
650495	Without teeth	12 cm
650498	With teeth	12 cm

ADSON BROWN FORCEPS

Stainless steel dissecting forceps with satin matte finish.



Code	Model	Length
650335	With teeth	12 cm

ADSON GRAEFE FORCEPS

Stainless steel dissecting forceps with satin matte finish. Atraumatic bit.

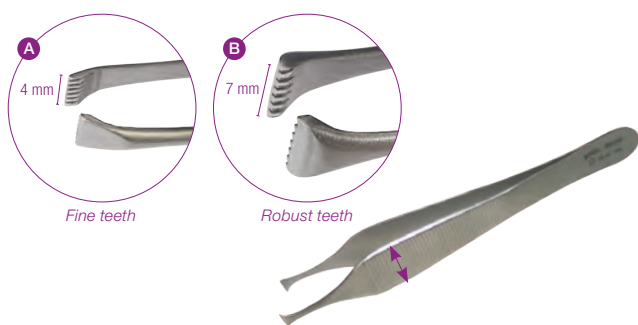

Code	Model	Length
A 650330	With fine teeth	12 cm
B 650332	With robust teeth	15 cm

GRAEFE FORCEPS

Stainless steel dissecting forceps with satin matte finish.

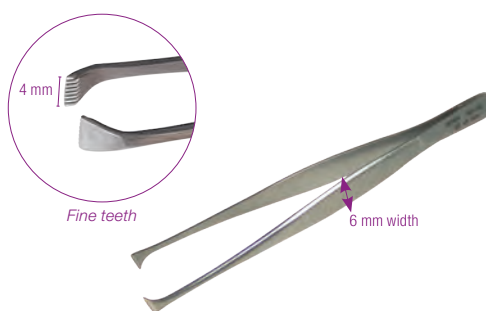

Code	Model	Length
650460	Straight, with teeth	11 cm

DEBAKEY FORCEPS

Stainless steel dissecting forceps with satin matte finish. Atraumatic bit.

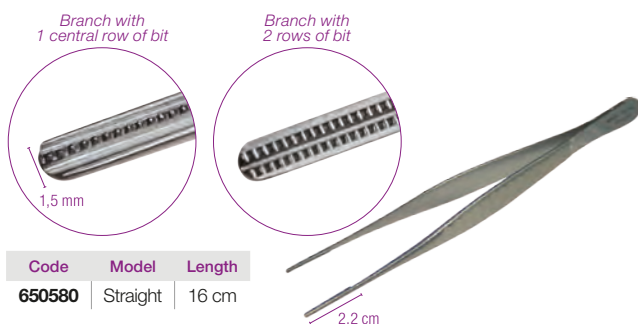

Code	Model	Length
650580	Straight	16 cm

TOWEL CLIP

Stainless steel surgical drapes forceps with satin matte finish. Fine end.



Code	Length
650882	9 cm



CRILE FORCEPS

Stainless steel haemostatic forceps with satin matte finish, surgical quality, locking handles.

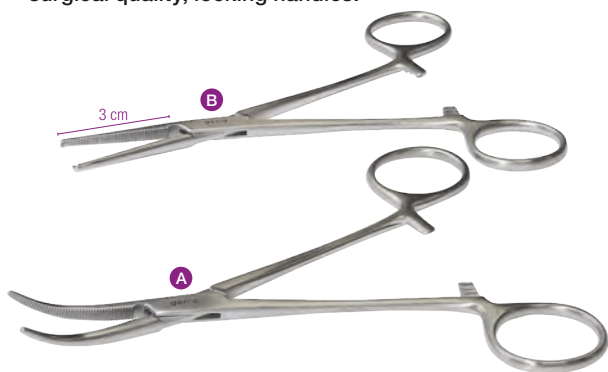

Code	Model	Length
657014	Straight, without teeth	14 cm
A 657020	Curved, without teeth	14 cm
B 657018	Straight, with teeth	14 cm
657016	Curved, with teeth	14 cm

HALSTEAD MOSQUITO FORCEPS

Stainless steel haemostatic forceps with satin matte finish, surgical quality, locking handles.



Code	Model	Length
657004	Straight, without teeth	12 cm
A 657006	Curved, without teeth	12 cm
B 657008	Straight, with teeth	12 cm
657012	Curved, with teeth	12 cm

KELLY FORCEPS

Stainless steel haemostatic forceps with satin matte finish, surgical quality, locking handles.

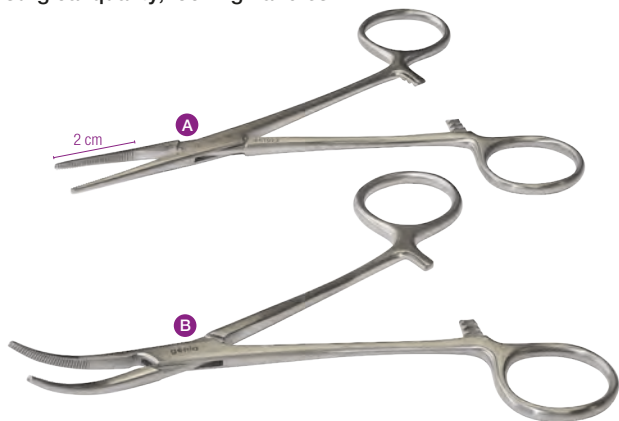

Code	Model	Length
A 657022	Straight, without teeth	14 cm
B 657024	Curved, without teeth	14 cm

ROCHESTER PEAN/KOCHER FORCEPS

Stainless steel haemostatic forceps with satin matte finish, surgical quality, locking handles.

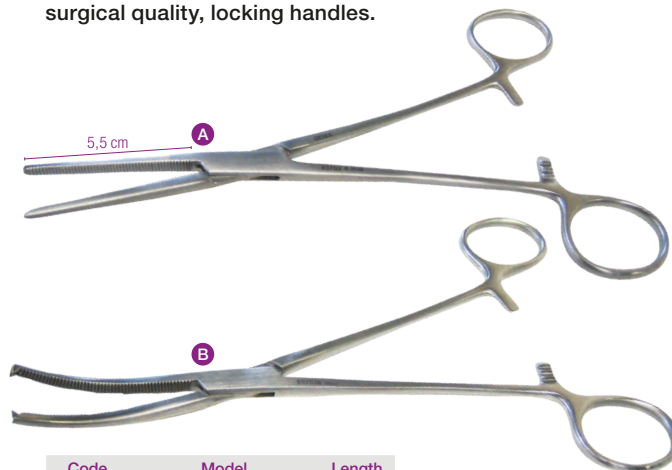

Code	Model	Length
A 657030	Straight, without teeth	18 cm
657032	Curved, without teeth	18 cm
657034	Straight, with teeth	18 cm
B 657036	Curved, with teeth	18 cm

ALLIS FORCEPS

Stainless steel haemostatic forceps with satin matte finish, surgical quality, locking handles.

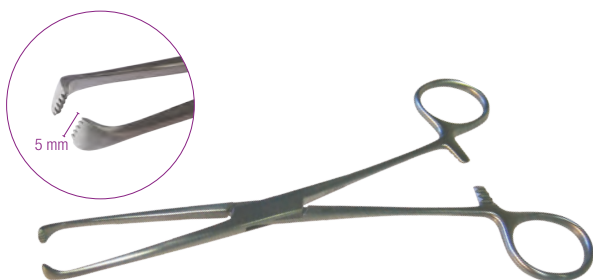

Code	Model	Length
657000	Straight, with teeth	15.5 cm

RIGHT ANGLE CLAMP

Stainless steel clamp with satin matte finish, surgical quality. Angle of 90°. Can be use with Fomon scissors (code 600777 p.47).



Code	Length
657052	14 cm

p.47 Find Fomon scissors



OVARIECTOMY HOOK

Ovariectomy hook in surgical quality.

- Round knurled handle for an excellent grip.
- Ball of medium size for an optimal grip.

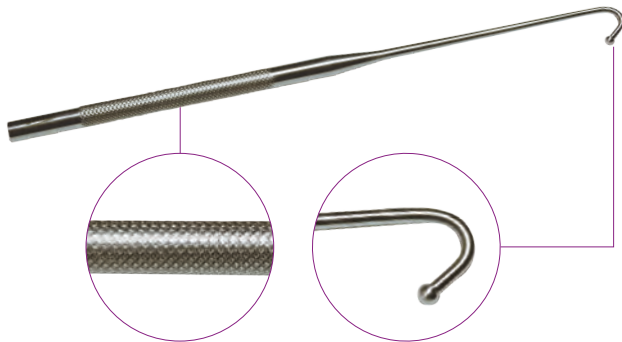

Code	Ball diameter	Length
220360	6 mm	17,5 cm

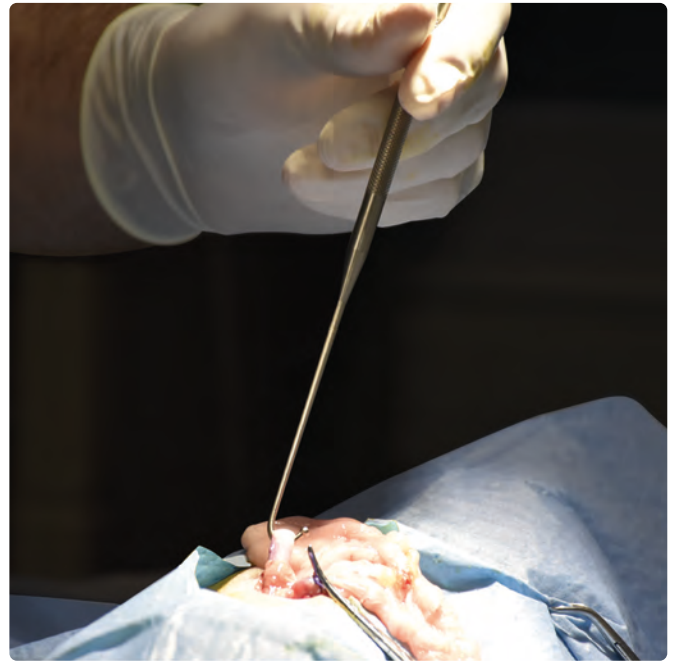

GELPI RETRACTOR

Surgical quality.

- Auto-static.
- 1x1 sharps end with rack.



Code	Length
630010	14 cm

HARTMANN FORCEPS

Stainless steel Hartmann foreign body forceps with a pointed end for easier passage through narrow speculums. Shine finish.



Code	Length
307976	8 cm
307975	14 cm

KILLIAN SPECULUM

Stainless steel Killian vaginal speculum with locking screw for small animals. Shine finish.



Code	Length
307980	9 cm

STAPVET

Sterile disposable 35W skin stapler.

- 35 stainless steel staples (7mm x 4mm).
 - Angled head for good visibility, ergonomic handle for good handling.
 - Easy and precise staple placement. Holds the wound perfectly.
- Supplied individually sterilely wrapped in boxes of 10.



Code x 10	Model
227860	35W stapler



Watch the video version on our website!



STAPLE REMOVER

Disposable skin staple remover.

- Easy to handle.
- The round and curved ends are designed not to hurt the skin and to fit easily under staples.

Supplied individually sterilely wrapped in boxes of 10.



ATRAUMATIC
END

Code x 10	Model
227862	Staple remover

NECROPSY KNIFE

Necropsy knife with heavy-duty replaceable blade.



Code	Model
307958	Blade holder only
307959	Bag of 10 blades

ASPIRATION CANNULAS

Sterile, disposable angled aspiration cannulas without finger controle.

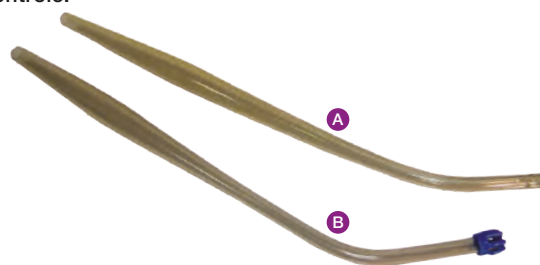

Code	Length	Outside diameter	Model
307400	260 mm	4 mm	Without strainer
A 307401	250 mm	6 mm	Without strainer
B 307410	250 mm	6 mm	With strainer

NECROPSY SCISSORS

Carbon steel chrome-plated scissors.



Code	Finish	Length
307922	Surgical	19 cm



■ DRAPVET

Disposable surgical drapes, non-woven, sterile.

- One smooth waterproof layer.
- One non-woven, comfortable and absorbent layer that is soft like fabric.
- Excellent handling when cut: Does not rip, clean cut.
- Thick coverage which moulds easily to the animal's body.

Supplied individually in a sterile packaging in boxes of 6, 12 or 24.

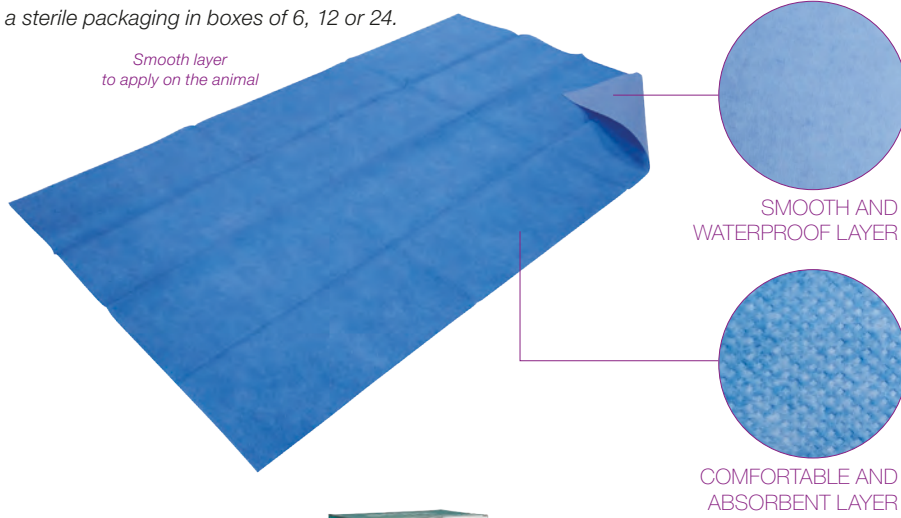

Code x 24	Dimensions	Pack.
317178	45 x 75 cm	x 24
317180	75 x 90 cm	x 12
317182	125 x 125 cm	x 12
317184	200 x 300 cm	x 6



DISPLACED ABOMASUM TREATMENT TROCAR

Stainless steel trocar for treating displaced abomasum using the Grymer Sterner method.

- 5/6 mm milled trocar.
- Plastic handle and 112 mm metal cannula.



Code	Model
340000	Compl. displ. abomasum treatment trocar
220400	Stainless steel cannula

GRYMER STERNER DISPLACED ABOMASUM TOGGLE SUTURES

Stainless steel toggle sutures for displaced abomasum repair via right flank omentopexy using the Grymer Sterner method.

Supplied in plastic bag of 2 or 12.

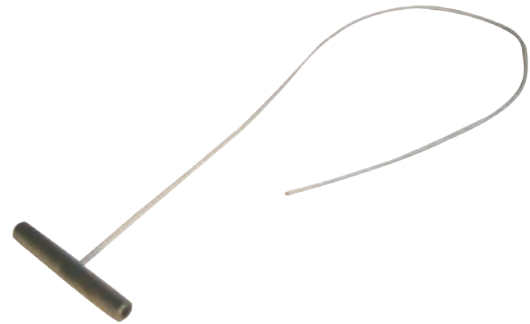

Code	Model	Pack.
340019	Displaced abomasum toggle sutures, hollow	x 2
347015	Displaced abomasum toggle sutures, hollow	x 12

PLASTIC BUTTONS FOR DISPLACED ABOMASUM REPAIR

Plastic buttons for displaced abomasum repair by right flank omentopexy.

Supplied in polyethylene bag of 6.



Length
Large model: 93 mm
Small model: 57 mm

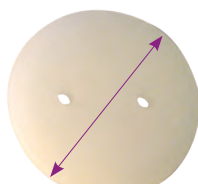

Diameter
Large model: 40 mm
Small model: 29 mm

Code x 6	Model	Dimensions
340007	Small (1 oval + 1 circular)	57 x 23 x 29 mm
340010	Large (1 oval + 1 circular)	93 x 23 x 40 mm



■ BÜHNERS VAGINAL TAPE

Braided silk suture tape for veterinary use to prevent prolapse.

- Less dangerous and more secure than safety pins.

Supplied on a reel in a polyethylene bag with instructions for use.



Code	Model	Length	Int. diameter
220852	Sheep	5 m x 4 mm	2.5 mm
220850	Cow	5 m x 7 mm	6.5 mm

■ PESSARY

Plastic pessary with 40 cm straps to prevent prolapse in ewes.

- Size: 26 x 16 cm.
- Soft pessary.

Supplied in a polyethylene bag.



Code	Model
220800	Pessary only
220805	Bag of 6 pessaries with 18 straps and instructions
220810	Strap by meter (100 meter roll)

■ CAESAREAN FORCEPS

Stainless steel Caesarean forceps with replaceable silicone jaws for large animals.

Supplied individually.

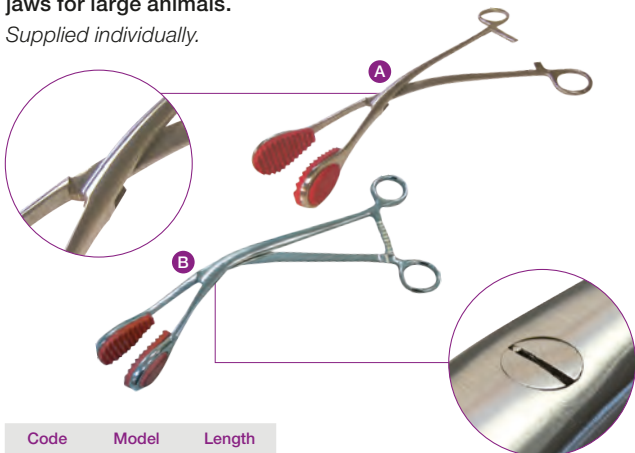

Code	Model	Length
A 227076	Finger	28 cm
B 227077	Screw	28 cm

ACCESSORIES

Code	Model
227087	Replacement silicone jaws, pair

■ BÜHNER'S NEEDLES

Stainless steel suture needles with handles, used to insert Bühners vaginal suture tape.



	Code	Model	Length
A	227902	Standard	20.5 cm
	227903	Tapered	20.5 cm
	227900	Standard	30 cm
B	227901	Tapered	30 cm

■ SAFETY PINS

Veterinary quality vulvar safety pins with protected trocar point.

- Top quality.
- Tapered tip.

Supplied by 10.

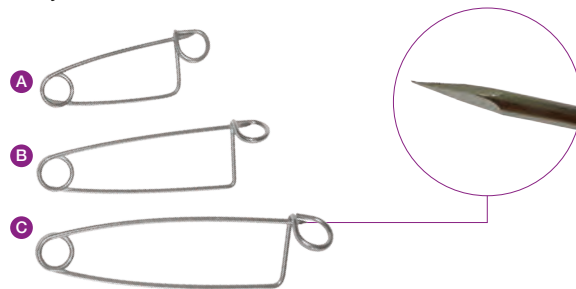

	Code x 10	Model	Length
A	220890	Small	6 cm
B	220892	Medium	8 cm
C	220894	Large	11 cm

■ C-CUT

Disposable, plastic hysterectomy scalpel for large animal Caesarean sections.

- Hole to attach a strap.

Supplied by bag of 10.

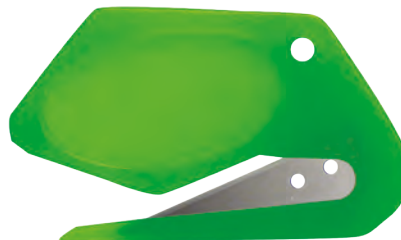

Code x 10	Model
307985	C-cut

RIGID
SHARP

p.125 Find our protective gowns





ORTHOPEDICS

External fixation and pins

Smooth pins	59
Threaded pins	60
External fixation rods and clamps	61

Screws and plates

Screws	62
Plates	63

Osteosynthesis accessories	65
---	-----------

Rehabilitation.....	67
----------------------------	-----------

>> MATERIAL CHOICE

Our veterinary implants are made from **implantable surgical stainless steel (grade 316 LVM) of the highest quality**. It is the same steel used for the production of implants for human use, compliant with the 5835:1991 industrial standards and Grade 2 ASTM F 138.

These standards concern the composition, microstructure, mechanical properties and metallurgical requirements of implants.

>> PHYSICAL AND CHEMICAL PROPERTIES

This steel is highly corrosion-resistant in a hostile biological environment. The mechanical properties optimally balance resistance and ductility. Our implant design, complying with **AOVET** standards, guarantees suitable **resistance and rigidity** for fracture fixation in both companion animals and large animals.

>> TECHNICAL EXPERTISE

Our implants are manufactured with care by **qualified and experienced employees**.

The finishing touches of the surface (polishing), the dimensional tolerance and the quality of the execution are subject to strict quality control. This guarantees the highest quality for veterinary applications.

>> QUALITY AND TRACEABILITY

Our **France-based factory** has been **ISO 9001-certified since 2007**. Each implant produced by our workshops is tested for quality control. The traceability is guaranteed from the raw material supply to the delivery to our clients. The same directives for the production of hospital equipment are followed for producing our veterinary equipment. This is a guarantee of our **integrity and the reliability** of our products.

OSTEOSYNTHESIS EQUIPMENT

Prior to performing any type of orthopedic surgery, verify that you have all the required equipment.

Forceps	To handle bones and bone fragments, assist in and maintain reduction and position and hold plates
Gelpi retractors (p.52, 66)	To move skin, subcutaneous tissue and muscle away from the fracture
Drill bits, Drilling guide	To drill the bone cavity in which the screw will be implanted
Measuring instrument	To measure the length of screw to use
Surgical motor	To insert the implants
Plates (p.63), Pins (p.59), Nails, External Fixators (p.61), Splints (p.61), Cerclage Wires (p.65), Screws (p.62)	Osteosynthesis instruments
Taps, Tap holder	To make the screw thread impression to facilitate screwing, thereby avoiding a bone fracture (not necessary with self-tapping screws).
Hexagonal screwdriver	Screwing - one for Ø 1.5 and 2.0 mm screws - one for Ø 2.7, 3.5 and 4.0 mm screws - one for Ø 4.5 and 6.5 mm screws

INDICATIONS FOR VARIOUS OSTEOSYNTHESIS IMPLANTS

Several types of implants are used to reduce a fracture. Each has its own specific indications.

IMPLANT TYPE	INDICATIONS
External fixators	<ul style="list-style-type: none"> - Localised fractures in distal bone areas (tibia, radius, ulna) - Temporary immobilisation of open fractures - Open fractures with a risk of skin necrosis - Transarticular fixation
Screws and plates	<p>All types of non-septic fractures of long bones (limbs) and flat bones (face, scapula and pelvis) and axial skeleton (vertebrae).</p> <p>Articular fractures: anatomical reduction required; stabilisation can be fully achieved only after anatomical reduction and interfragmentary compression.</p> <p>Pseudoarthrosis: enables compression of the area and provides the excellent stability required for healing. In this case, it is often combined with an autograft of spongy bone.</p> <p>Corrective osteotomy: triple pelvic osteotomy, tibial plateau-levelling osteotomy, varus-producing femoral osteotomy.</p> <p>Provides early support for fractures in various limbs, preventing prolonged bedrest.</p>
Locking screws	<ul style="list-style-type: none"> - Reduction and stabilisation of diaphyseal fractures - Pseudoarthrosis, poor healing, non-union - Treatment of pathological fractures

■ SURGICAL PIN WITH ONE TROCAR POINT, ONE ROUND END

Made exclusively from surgical stainless steel.

- Diameter from 1 to 8 mm.
- Length from 10 to 30 cm.

Supplied by 3 or 10.

On demand: other diameters and lengths.



Code x 3	Code x 10	Diameter	Length
26A1010	26K1010	1 mm	10 cm
26A1012	26K1012	1 mm	12 cm
26A1015	26K1015	1 mm	15 cm
26A1020	26K1020	1 mm	20 cm
26A1030	26K1030	1 mm	30 cm
26A1210	26K1210	1.2 mm	10 cm
26A1212	26K1212	1.2 mm	12 cm
26A1215	26K1215	1.2 mm	15 cm
26A1220	26K1220	1.2 mm	20 cm
26A1230	26K1230	1.2 mm	30 cm
26A1415	26K1415	1.4 mm	15 cm
26A1420	26K1420	1.4 mm	20 cm
26A1425	26K1425	1.4 mm	25 cm
26A1430	26K1430	1.4 mm	30 cm
26A1510	26K1510	1.5 mm	10 cm
26A1512	26K1512	1.5 mm	12 cm

Code x 3	Code x 10	Diameter	Length
26A1515	26K1515	1.5 mm	15 cm
26A1520	26K1520	1.5 mm	20 cm
26A1530	26K1530	1.5 mm	30 cm
26A1612	26K1612	1.6 mm	12 cm
26A1620	26K1620	1.6 mm	20 cm
26A1630	26K1630	1.6 mm	30 cm
26A1812	26K1812	1.8 mm	12 cm
26A1820	26K1820	1.8 mm	20 cm
26A2010	26K2010	2 mm	10 cm
26A2012	26K2012	2 mm	12 cm
26A2015	26K2015	2 mm	15 cm
26A2020	26K2020	2 mm	20 cm
26A2025	26K2025	2 mm	25 cm
26A2030	26K2030	2 mm	30 cm
26A2512	26K2512	2.5 mm	12 cm

Code x 3	Code x 10	Diameter	Length
26A2520	26K2520	2.5 mm	20 cm
26A2530	26K2530	2.5 mm	30 cm
26A3012	26K3012	3 mm	12 cm
26A3015	26K3015	3 mm	15 cm
26A3020	26K3020	3 mm	20 cm
26A3025	26K3025	3 mm	25 cm
26A3030	26K3030	3 mm	30 cm
26A3520	26K3520	3.5 mm	20 cm
26A3530	26K3530	3.5 mm	30 cm
26A4020	26K4020	4 mm	20 cm
26A4025	26K4025	4 mm	25 cm
26A4030	26K4030	4 mm	30 cm
26A5025	26K5025	5 mm	25 cm
26A5030	26K5030	5 mm	30 cm
26A6030	26K6030	6 mm	30 cm
26A8030*	26K8030	8 mm	30 cm

*Supplied by 2.

■ SURGICAL PIN WITH TWO TROCAR POINTS

Made exclusively from surgical stainless steel.

- Diameter from 0.8 to 8 mm.
- Length from 12 to 30 cm.

Supplied by 3 or 10.

On demand: other lengths.



Sharp and angular trocar point

Less bone heating and therefore less necrosis during placement

Code x 3	Code x 10	Diameter	Length
26B0812	26M0812	0.8 mm	12 cm
26B0830	26M0830	0.8 mm	30 cm
26B1010	26M1010	1 mm	10 cm
26B1012	26M1012	1 mm	12 cm
26B1020	26M1020	1 mm	20 cm
26B1025	26M1025	1 mm	25 cm
26B1030	26M1030	1 mm	30 cm
26B1212	26M1212	1.2 mm	12 cm
26B1220	26M1220	1.2 mm	20 cm
26B1230	26M1230	1.2 mm	30 cm
26B1415	26M1415	1.4 mm	15 cm
26B1420	26M1420	1.4 mm	20 cm
26B1430	26M1430	1.4 mm	30 cm
26B1512	26M1512	1.5 mm	12 cm
26B1515	26M1515	1.5 mm	15 cm
26B1520	26M1520	1.5 mm	20 cm
26B1525	26M1525	1.5 mm	25 cm
26B1530	26M1530	1.5 mm	30 cm

Code x 3	Code x 10	Diameter	Length
26B1620	26M1620	1.6 mm	20 cm
26B1630	26M1630	1.6 mm	30 cm
26B1812	26M1812	1.8 mm	12 cm
26B1820	26M1820	1.8 mm	20 cm
26B1830	26M1830	1.8 mm	30 cm
26B2012	26M2012	2 mm	12 cm
26B2015	26M2015	2 mm	15 cm
26B2020	26M2020	2 mm	20 cm
26B2025	26M2025	2 mm	25 cm
26B2030	26M2030	2 mm	30 cm
26B2212	26M2212	2.2 mm	12 cm
26B2220	26M2220	2.2 mm	20 cm
26B2230	26M2230	2.2 mm	30 cm
26B2512	26M2512	2.5 mm	12 cm
26B2515	26M2515	2.5 mm	15 cm
26B2520	26M2520	2.5 mm	20 cm
26B2525	26M2525	2.5 mm	25 cm
26B2530	26M2530	2.5 mm	30 cm

Code x 3	Code x 10	Diameter	Length
26B3012	26M3012	3 mm	12 cm
26B3015	26M3015	3 mm	15 cm
26B3020	26M3020	3 mm	20 cm
26B3025	26M3025	3 mm	25 cm
26B3030	26M3030	3 mm	30 cm
26B3520	26M3520	3.5 mm	20 cm
26B3525	26M3525	3.5 mm	25 cm
26B3530	26M3530	3.5 mm	30 cm
26B4020	26M4020	4 mm	20 cm
26B4025	26M4025	4 mm	25 cm
26B4030	26M4030	4 mm	30 cm
26B5025	26M5025	5 mm	25 cm
26B5030	26M5030	5 mm	30 cm
26B6025	26M6025	6 mm	25 cm
26B6030	26M6030	6 mm	30 cm
26B7025	26M7025	7 mm	25 cm
26B7030	26M7030	7 mm	30 cm
26B8030*	26M8030	8 mm	30 cm

*Supplied by 2.

■ SURGICAL PIN WITH ONE DIAMOND POINT, ONE ROUND END

Made exclusively from surgical stainless steel.

- Diameter from 0.8 to 3 mm.
- Length of 15 cm.

Supplied by 3.

On demand: other diameters and lengths.



Code x 3	Diameter	Length
26G0815	0.8 mm	15 cm
26G1015	1 mm	15 cm
26G1215	1.2 mm	15 cm
26G1515	1.5 mm	15 cm
26G1815	1.8 mm	15 cm
26G2015	2 mm	15 cm
26G3015	3 mm	15 cm

■ POSITIVE THREADED SURGICAL PIN WITH ONE TROCAR POINT

Made exclusively from surgical stainless steel. Distal or central thread. The thread guarantees stability of the fixation. The bone anchor limits the pin movement and thus osteolysis due to instability.

- Diameter from 0.8 to 4 mm.
- Length from 10 to 20 cm.

Supplied by 3 or 10.

On demand: other diameters and lengths (0.6 mm diameter for exotics).

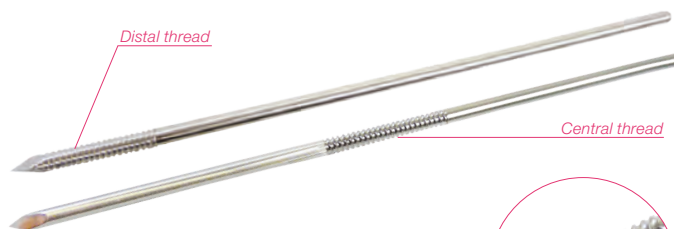

POSITIVE THREAD FOR GREATER STABILITY

CENTRAL THREAD

Code x 3	Code x 10	Pin		Thread	
		Diameter	Length	Diameter	Length
33C0810	31C0810	0.8 mm	10 cm	-	-
33C1012	31C1012	1 mm	12 cm	1.3 mm	15 mm
33C1212	31C1212	1.2 mm	12 cm	1.5 mm	15 mm
33C1512	31C1512	1.5 mm	12 cm	1.9 mm	15 mm
33C1815	31C1815	1.8 mm	15 cm	2.3 mm	15 mm
33C2015	31C2015	2 mm	15 cm	2.7 mm	20 mm
33C2515	31C2515	2.5 mm	15 cm	3 mm	30 mm
33C3020	31C3020	3 mm	20 cm	3.7 mm	30 mm
33C3520	31C3520	3.5 mm	20 cm	4.3 mm	30 mm
33C4020	31C4020	4 mm	20 cm	4.8 mm	30 mm

DISTAL THREAD

Code x 3	Code x 10	Pin		Thread	
		Diameter	Length	Diameter	Length
33P0810	31P0810	0.8 mm	10 cm	-	-
33P1012	31P1012	1 mm	12 cm	1.3 mm	15 mm
33P1212	31P1212	1.2 mm	12 cm	1.5 mm	15 mm
33P1512	31P1512	1.5 mm	12 cm	1.9 mm	15 mm
33P1812	31P1812	1.8 mm	12 cm	2.3 mm	15 mm
33P2012	31P2012	2 mm	12 cm	2.7 mm	20 mm
33P2512	31P2512	2.5 mm	12 cm	3 mm	25 mm
33P3015	31P3015	3 mm	15 cm	3.7 mm	25 mm
33P3515	31P3515	3.5 mm	15 cm	4.3 mm	30 mm
33P4015	31P4015	4 mm	15 cm	4.8 mm	30 mm

■ SURGICAL PIN WITH TWO TROCAR POINTS, NEGATIVE THREADED ON ONE END

Made exclusively from surgical stainless steel.

- Diameter from 1 to 6 mm.
- Length from 12 to 30 cm.

Supplied by 3 or 10.

On demand: other diameters and lengths.



Code x 3	Code x 10	Diameter	Length
26E1012	26T1012	1 mm	12 cm
26E1020	26T1020	1 mm	20 cm
26E1025	26T1025	1 mm	25 cm
26E1430	26T1430	1.4 mm	30 cm
26E1520	26T1520	1.5 mm	20 cm
26E1525	26T1525	1.5 mm	25 cm
26E1530	26T1530	1.5 mm	30 cm
26E1630	26T1630	1.6 mm	30 cm
26E1820	26T1820	1.8 mm	20 cm

Code x 3	Code x 10	Diameter	Length
26E1830	26T1830	1.8 mm	30 cm
26E2025	26T2025	2 mm	25 cm
26E2030	26T2030	2 mm	30 cm
26E2230	26T2230	2.2 mm	30 cm
26E2520	26T2520	2.5 mm	20 cm
26E2525	26T2525	2.5 mm	25 cm
26E2530	26T2530	2.5 mm	30 cm
26E3020	26T3020	3 mm	20 cm
26E3025	26T3025	3 mm	25 cm
26E3030	26T3030	3 mm	30 cm

Code x 3	Code x 10	Diameter	Length
26E3520	26T3520	3.5 mm	20 cm
26E3525	26T3525	3.5 mm	25 cm
26E3530	26T3530	3.5 mm	30 cm
26E4020	26T4020	4 mm	20 cm
26E4025	26T4025	4 mm	25 cm
26E4030	26T4030	4 mm	30 cm
26E4525	26T4525	4.5 mm	25 cm
26E5030	26T5030	5 mm	30 cm
26E6030	26T6030	6 mm	30 cm

■ SURGICAL PIN WITH ONE NEGATIVE THREADED TROCAR POINT, ONE DIAMOND POINT

Made exclusively from surgical stainless steel.

- Diameter from 1 to 6 mm.
- Length from 20 to 30 cm.

Supplied by 3.

On demand: other diameters and lengths.



Code x 3	Diameter	Length
26F1020	1 mm	20 cm
26F1220	1.2 mm	20 cm
26F1420	1.4 mm	20 cm
26F1520	1.5 mm	20 cm
26F1620	1.6 mm	20 cm
26F1820	1.8 mm	20 cm
26F2020	2 mm	20 cm
26F2520	2.5 mm	20 cm

Code x 3	Diameter	Length
26F2525	2.5 mm	25 cm
26F3025	3 mm	25 cm
26F3525	3.5 mm	25 cm
26F4025	4 mm	25 cm
26F4030	4 mm	30 cm
26F5030	5 mm	30 cm
26F6030	6 mm	30 cm



PIN PLACEMENT

The position of the thread (central or distal) correlates to the clamp setting.

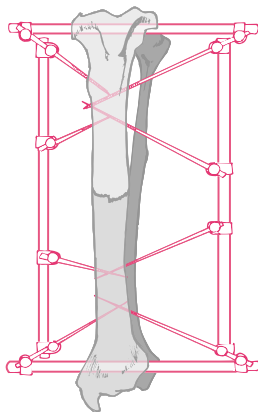

Distal thread

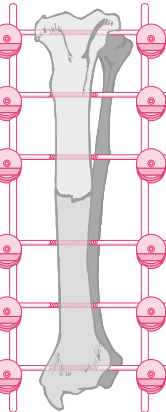
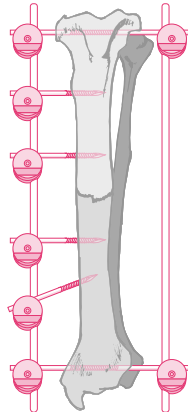

Central thread

These pins are made from implantable surgical stainless steel (grade 316 LVM) of the highest quality to maximise tolerance and stability of the implant.

- Our trocar point reduces bone heating and therefore necrosis during fitting.
- The thread guarantees stability of the system. The bone anchor limits pin movement and therefore osteolysis due to instability.
- The positive thread provides greater stability than negative thread; a negative threaded pin has the same diameter over its entire length. The positive thread eliminates the fragile thread-pin interface.

FIXATION CLAMPS

Non-surgical stainless steel external fixators (diameters 12, 14 and 16 in stainless steel, diameters 24 and 32 in chrome-plated brass). Each fixator is labelled excepted large animal models.

- Diameter from 12 to 32 mm.
- Supplied by 6 or 25.

On demand: other models.



Code x 6	Code x 25	Diameter	Diameter of outside rod	Diameter of transfixing pin	Pin length	Use
260020	259912	12 mm	2 mm	1.2 mm	12 cm	Cat
260022	259914	12 mm	2 mm	1.5 mm	12 cm	Cat
260023	259916	14 mm	3 mm	1.5 mm	12 cm	Little dog
260019	259918	14 mm	3 mm	1.8 mm	12 cm	Little dog
260024	259920	14 mm	3 mm	2 mm	12 cm	Medium dog
260026	259922	16 mm	4 mm	2 mm	15 cm	Medium dog
260027	259924	16 mm	4 mm	2.5 mm	15 cm	Big dog
260028	259926	16 mm	4 mm	3 mm	15 cm	Big dog
260030	259928	24 mm	4 mm	6 mm	15 cm	Large animals
260032	259930	32 mm	8 mm	4 mm	25 cm	Large animals
260034	259932	32 mm	8 mm	6 mm	25 cm	Large animals

REPLACEMENT SCREW FOR CLAMPS

Code x 6	Diameter
260046	12 mm
260047	14 and 16 mm
260048	24 mm
260049	32 mm

EXTERNAL FIXATION RODS FOR SURGICAL PINS

Bevelled external fixation rods for surgical pins, polished at the ends and labelled. Non-surgical stainless steel. Cannot be implanted.

- Diameter from 2 to 8 mm.
- Length of 50 cm.

Supplied by 6.

On demand: other diameters and lengths.



Code x 6	Diameter	Length	Clamp
260160	2 mm	50 cm	12
260162	3 mm	50 cm	14
260164	4 mm	50 cm	16
260168	6 mm	50 cm	24
260170	8 mm	50 cm	32



SCREW SELECTION GUIDE*

*For reference.

Each screw in Génia's catalogue is compatible with standard screwdrivers and taps.

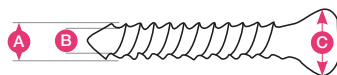

SELF-TAPPING CORTICAL SCREWS

SCREW DIAMETER			SCREW-DRIVER	SCREW DIAMETER
THREAD A	CORE B	HEAD C	HEXAGONAL HEAD	THREADED HOLE
1.5 mm	1.0 mm	3 mm	1.5 mm	1.1 mm
2.0 mm	1.3 mm	4 mm	1.5 mm	1.5 mm
2.7 mm	1.9 mm	5 mm	2.5 mm	2.0 mm
3.5 mm	2.4 mm	6 mm	2.5 mm	2.5 mm
4.5 mm**	3.0 mm	8 mm	4.5 mm	3.1 mm

On demand: 4.5 mm diameter

USES BASED ON CHARACTERISTICS

DIAMETER	LENGTH	TYPE	USE
1.5 mm	6 - 20 mm	Cortical	Mini-implant (digit, Cat)
2.0 mm	6 - 30 mm	Cortical	Mini-implant (digit, Cat)
2.7 mm	6 - 44 mm	Cortical	Cat, small dog (5-7kg) + pelvis
3.5 mm	8 - 60 mm	Cortical	Dog > 10 kg
3.5 mm	10 - 80 mm	Cancellous	Dog > 10 kg
4.5 mm	14 - 70 mm	Cortical	Dog > 50 kg, horses and cattle
6.5 mm	25 - 80 mm	Cancellous	Dog > 50 kg, horses and cattle

■ SELF-TAPPING CORTICAL SCREWS

Spherical collar and hexagonal head cortical screws.

- Made exclusively from surgical stainless steel.

Supplied by 6.



SELF-TAPPING |
FOR QUICK INSERTION |

Diameter 1.5 mm	Diameter 2.0 mm	Diameter 2.7 mm	Diameter 3.5 mm	Length
265500	265568	265636	-	6 mm
265501	-	-	-	7 mm
265502	265570	265638	265706	8 mm
265503	-	-	-	9 mm
265504	265572	265640	265708	10 mm
265506	265574	265642	265710	12 mm
265508	265576	265644	265712	14 mm
265510	265578	265646	265714	16 mm
265512	265580	265648	265716	18 mm
265514	265582	265650	265718	20 mm
-	265584	265652	265720	22 mm
-	265586	265654	265722	24 mm
-	265588	265656	265724	25 mm
-	265590	265658	265726	26 mm
-	265592	265660	265728	28 mm
-	265594	265662	265730	30 mm
-	-	265664	265732	32 mm
-	-	265666	265734	34 mm
-	-	265668	265736	35 mm
-	-	265670	265738	36 mm
-	-	265672	265740	38 mm
-	-	265674	265742	40 mm
-	-	265676	265744	42 mm
-	-	265678	265746	44 mm
-	-	-	265748	45 mm
-	-	-	265750	46 mm
-	-	-	265752	48 mm
-	-	-	265754	50 mm
-	-	-	265756	52 mm
-	-	-	265758	54 mm
-	-	-	265760	55 mm
-	-	-	265762	56 mm
-	-	-	265764	58 mm
-	-	-	265766	60 mm

On demand:
4.5 mm diameter

■ CANCELLOUS SCREWS

Spherical collar and hexagonal head cancellous screws.

- Made exclusively from surgical stainless steel.
- 3.5 mm thread diameter.
- Length from 10 to 80 mm.

Supplied in bag of 6.



Diameter 3.5 mm	Length
264444	10 mm
264446	12 mm
264448	14 mm
264450	16 mm
264462	28 mm
264464	30 mm
264466	32 mm
264468	34 mm
264470	36 mm
264472	38 mm
264474	40 mm
264476	45 mm
264478	50 mm
264480	55 mm
264482	60 mm
264484	65 mm
264486	70 mm
264488	75 mm
264490	80 mm

On demand:
6.5 mm diameter



PLATE SELECTION GUIDE*

*for reference.

The type and size of plate depends on the mechanical properties of the implant.
 The implant must resist flexion forces applied to the bone when the bone is healing.
 The choice also depends on the weight of the animal, the size of the fracture fragment and the position of the fracture line(s).

	0 kg	10 kg	20 kg	30 kg	40 kg	50 kg	60 kg
Humérus	2.7 DCP ¹			4.5 DCP ¹ or broad 4,5			
	3.5 DCP ¹		broad 3.5 DCP ¹ or 4.5				
Radius Ulna	2.7 DCP ¹		3.5 DCP ¹			broad 3.5 DCP ¹ or 4.5	
Fémur	VCP ²		3.5 DCP ¹		broad 4.5 DCP ¹		
	2.7 DCP ¹		broad 3.5 DCP ¹ or 4.5				
Tibia	VCP ²		3.5 DCP ¹		broad 4.5 DCP ¹		
	VCP ²		2.7 DCP ¹		broad 3.5 DCP ¹ or 4.5		

¹Dynamic Compression Plate (DCP)
²Veterinary Cuttable Plate (VCP)

CUTTABLE PLATES

Range of VCP** plates, with different profiles (flat, one-third tubular, curved).

- Made exclusively from surgical stainless steel.
- Plates fit 2.0 mm, 2.7 mm and 3.5 mm diameter screws.
- From 20 to 55 round or oblong holes.

** Veterinary Cuttable Plate.

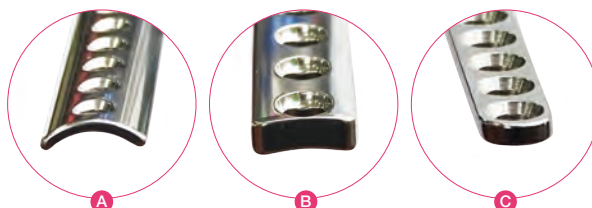

Code	Hole type	Model		Number of holes	Length	Thickness	Width	Screw diameter
266150	Round	Curved	B	28	336 mm	3.2 mm	10.2 mm	3.5 mm
266152	Round	Curved	B	28	336 mm	4 mm	11.6 mm	3.5 mm
266154	Round	Flat	C	41	328 mm	2.5 mm	8 mm	2.7 mm
266156	Round	One-third tubular	A	50	300 mm	1.1 mm	9 mm	2.7 mm
266158	Round	Flat	C	55	330 mm	2 mm	5 mm	2 mm
266160	Round	One-third tubular	A	50	300 mm	1.1 mm	9 mm	2 mm
266170	Oblong	Flat	C	20	100 mm	1.5 mm	5 mm	2 mm
266172	Oblong	Flat	C	20	100 mm	1 mm	4 mm	1.5 mm



■ DYNAMIC COMPRESSION PLATES

Range of narrow and broad DCP* plates.

- Made exclusively from surgical stainless steel.
- Length from 22 to 218 mm.
- Fits screw diameters of 2 or 2.7 mm: 4 to 12 holes.
- Fits screw diameters of 3.5 mm:
 - Narrow profile: 4 to 12 holes.
 - Broad profile: 5 to 18 holes.

*Dynamic Compression Plate.



AOVET
STANDARDS

STRAIGHT PLATE FOR SCREW:

Diameter 2 mm
Width: 5 mm
Distance interior holes: 5 mm
Distance center holes: 6.2 mm

Code	Holes	Length	Thickness
266002	4	22 mm	1 mm
266004	5	27 mm	1 mm
266006	6	32 mm	1.5 mm
266008	7	37 mm	1.5 mm
266010	8	42 mm	1.5 mm
266012	9	47 mm	1.5 mm
266014	10	52 mm	1.5 mm
266016	11	57 mm	1.5 mm
266018	12	62 mm	1.5 mm

STRAIGHT PLATE FOR SCREW:

Diameter 2.7 mm
Width: 8 mm
Distance interior holes: 8 mm
Distance center holes: 11.7 mm

Code	Holes	Length	Thickness
266020	4	36 mm	2 mm
266022	5	44 mm	2 mm
266024	6	52 mm	2.5 mm
266026	7	60 mm	2.5 mm
266028	8	68 mm	2.5 mm
266030	9	76 mm	2.5 mm
266032	10	84 mm	2.5 mm
266034	11	92 mm	2.5 mm
266036	12	100 mm	2.5 mm

STRAIGHT PLATE FOR SCREW:

Diameter 3.5 mm
Width: 10 mm
Thickness: 3.2 mm
Distance interior holes: 12 mm
Distance center holes: 16.6 mm

Code	Holes	Length
266038	4	50 mm
266040	5	62 mm
266042	6	74 mm
266044	7	86 mm
266046	8	98 mm
266048	9	110 mm
266050	10	122 mm
266052	11	134 mm
266054	12	146 mm

STRAIGHT PLATE FOR SCREW:

Diameter 3.5 mm
Width: 11.6 mm
Thickness: 4 mm
Distance interior holes: 12 mm
Distance center holes: 16.6 mm

Code	Holes	Length
266056	5	62 mm
266058	6	74 mm
266060	7	86 mm
266062	8	98 mm
266064	9	110 mm
266066	10	122 mm
266068	11	134 mm
266070	12	146 mm
266072	14	170 mm
266074	16	194 mm
266076	18	218 mm



■ CROWN SCISSORS

Crown or Beebe scissors with serrated blades for cutting surgical steel wire. Stainless steel with satin matte finish.



Code	Finish	Assembly	Model	Length
601170	Surgical	Screw	Straight	10 cm

■ ANGLED WIRE CUTTING SCISSORS

Stainless steel scissors with satin matte finish.



Code	Finish	Assembly	Model	Length
601165	Surgical	Screw	Bent	12 cm

■ SURGICAL STEEL WIRE

Surgical steel wire for cerclage.

- 10 m roll.



Code	Diameter
260200	0.2 mm
260201	0.4 mm
260202	0.5 mm
260203	0.6 mm
260204	0.7 mm
260205	0.8 mm
260206	0.9 mm
260207	1 mm
260208	1.2 mm
260209	1.5 mm

■ PIN DRIVER

Surgical stainless steel pin driver.

- Diameter of 4 and 6 mm.
- Length of 150 mm.



Code	Diameter
261002	4 mm
261004	6 mm



■ BONE PIN CHUCKS

Knurled grip bone pin chucks in anodised aluminium for introducing intramedullary bone pins (diameters 0.8 to 8 mm).

Supplied complete with extension and lock key.

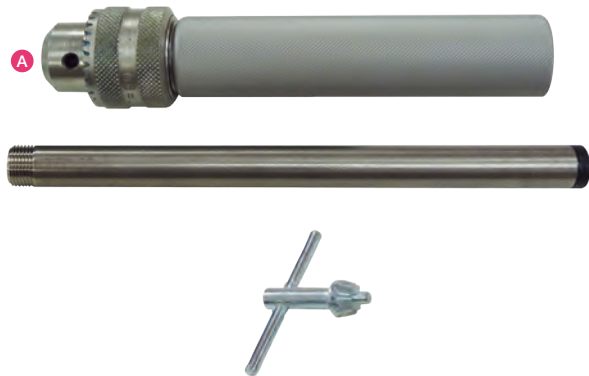

	Code	Diameter	Model
A	261012	6 mm	Stainless steel
	261014	10 mm	Stainless steel
	261017	-	Stainless steel extension only

p.59 [Find surgical pins](#)

■ CHUCK KEYS

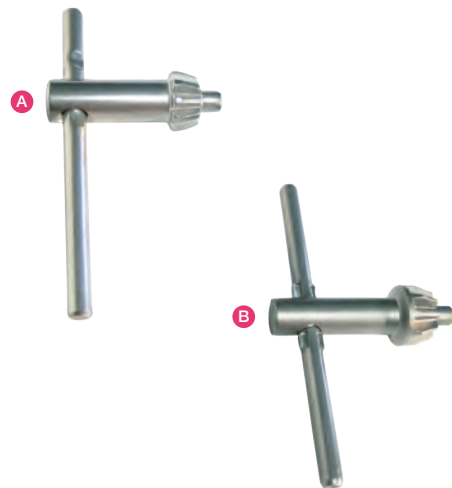

	Code	Model
A	261021	Key for 6 mm chuck in stainless steel
B	261022	Key for 10 mm chuck in stainless steel

■ HOHMANN RETRACTOR



Code	Length
630000	22 cm

■ GELPI RETRACTOR

Surgical quality.

- Auto-static.
- 1x1 sharps end with rack.



Code	Length
630010	14 cm

■ SURGICAL BUTTONS

Polypropylene buttons for cruciate ligament repair.

- Diameter of 8 and 15 mm.

Supplied by 6, non-sterile.



Code x 6	Diameter
340020	8 mm
340030	15 mm

HIND HANDY CANIS

Hand held harness, for mild to serious temporary or permanent paresis or paralysis of dogs' and cats' hind legs.

- Helps the animal to move and especially to climb on curbs and stairs.
- Heavy duty material (neoprene).
- Stretchy material, comfortable and easy to adjust.
- Fully washable.
- Adjusts to the animal's body with Velcro bands and adjustable straps.
- Adjustable lifting straps to accommodate the animal's size and the owner's comfort.
- Comfort handle to use with both lifting straps. ①



HIND MODEL

Code	Size	D Abdomen circumference min. and max.	E Thigh circumference min. and max.	Breed
227250	XS	30 - 33 cm	7.5 - 17 cm	Yorkshire, Chihuahua
227252	S	33 - 36 cm	15 - 23 cm	Dachshund
227254	M	36 - 50 cm	22 - 32 cm	Basset Hound
227256	L	50 - 63 cm	31 - 36 cm	Golden Retriever, German Shepherd
227258	XL	63 - 81 cm	37 - 53 cm	St. Bernard, Newfoundland

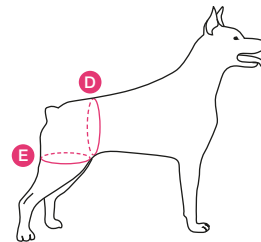

D) Abdomen circumference at groin.
E) Thigh circumference at groin.



CANIS-MOBILE®

Mobility cart to support the hind legs of dogs and cats in case of partial or total mobility loss.

- Welded, galvanised metal and aluminium chassis.
- Adjustable height and length.
- Adjustable straps.
- Removable protective neoprene for easy washing.
- Soft rubber wheels.
- Handle to lift the animal and help it climb over curbs.
- Axle offset to allow the use of the front legs.

Indications:

- Paralysis or paresis of dogs' hind legs, particularly in German Shepherds, Dachshunds, Labradors, etc.
- Functional rehabilitation following disc herniation.
- Temporary immobilisation of the hind legs following surgery or injury, cast, splint, external fixation, etc.

On request: models adjustable in dimensions A, B and C below.

Supplied with the corresponding hind Handy Canis (choose according to measurements D and E).



EASY TO ASSEMBLE CART |
EASY TO INSTALL HARNESS

Watch the video version
on our website!

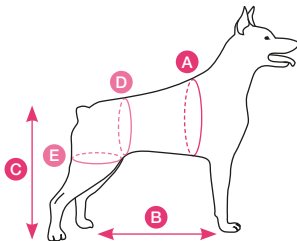

Canis-Mobile® measurements

- A) Thorax circumference behind the front legs.
- B) Length between the front and back legs.
- C) Tail height.

Hind Handy Canis measures

- D) Abdomen circumference at the groin.
- E) Thigh circumference at the groin.

Help with Canis-Mobile® selection: Measure A, B and C and determine the size of the model (small, medium or large). Then select the compatible hind Handy Canis using measurements D and E.

Code SET	Handy Canis size	HANDY CANIS measurements		Canis-Mobile® size	CANIS-MOBILE® measurements			Max. Weight	
		D Abdomen circumference min. and max.	E Thigh circumference min. and max.		A Thorax circumference	B Length min. and max.	C Tail height min. and max.		
260570	XS	30 - 33 cm	7.5 - 17 cm	Small	41 cm maxi	16 - 26 cm	17 - 27 cm	10 kg	
260571	S	33 - 36 cm	15 - 23 cm		Medium	66 cm maxi	25 - 35 cm	24 - 38 cm	30 kg
260574	S	33 - 36 cm	15 - 23 cm	Large		90 cm maxi	35 - 50 cm	41 - 56 cm	50 kg
260575	M	36 - 50 cm	22 - 32 cm		Large	90 cm maxi	35 - 50 cm	41 - 56 cm	50 kg
260580	L	50 - 63 cm	31 - 36 cm			90 cm maxi	35 - 50 cm	41 - 56 cm	50 kg
260581	XL	63 - 81 cm	37 - 53 cm						





HOSPITALIZATION

Disposables

E-collars	70
Protective equipment	74
Bandages	77
Dressings	80

Small animals identification	83
------------------------------------	----

Accessories	84
-------------------	----

Thermometers	86
--------------------	----

QUICK FASTENING SYSTEM

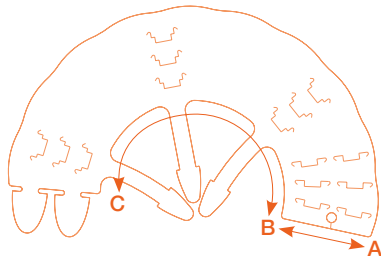

Quick fastening system secured with double interweaving tabs.

- 3 to 5 neck size options.
- Protects the head, abdomen and legs.
- Separate fasteners on the collar.
- Storage hole for hanging and selecting a collar simply by pulling it down.
- E-collar inks comply with FDA standards, non-toxic for animals.

ASSEMBLY

Push the side (widest) tabs into the selected slits, with the smooth side facing inward, and **then pull them through the adjacent slits.**

Repeat with the small tabs.



DISASSEMBLY

Firmly fold the part that is overhanging after assembly. Pull the tabs out of the slits.

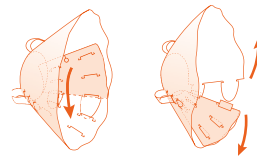

Code x 12 TRANSCOL	Code x 12 FUNCOL	Code x 12 GREENCOL	O/Pack.	Code x 12 NEOCOL	O/Pack.	Size (A-B)	Neck size (B-C)	
							min.	max.
306100	306200	306300	x 30	306420	x 10	7,5 cm	25 cm	28 cm
306102	306202	306302	x 30	306422	x 10	10 cm	22 cm	28 cm
306104	306204	306304	x 20	306424	x 10	12,5 cm	25 cm	33 cm
306106	306206	306306	x 12	306426	x 10	15 cm	33 cm	41 cm
-	306218	-	x 10	-	-	17,5 cm	35 cm	43 cm
306108	306208	306308	x 8	306428	x 10	20 cm	37 cm	46 cm
306110	306210	306310	x 6	306430	x 5	25 cm	43 cm	52 cm
306112	306212	306312	x 4	306432	x 5	30 cm	47 cm	58 cm
-	306213	306314	x 3	-	-	35 cm	54 cm	70 cm
-	306214	306315	x 3	-	-	40 cm	62 cm	80 cm
306116	306216*	306316	x 4	306438	x 5	Set (2x7 sizes, from 7.5 to 30 cm)		

*The Funcol® kit does not include the size 17.5 cm.

Watch the video version on our Youtube channel!



E-COLLAR AND COSYPAD® HANGER

Wall hanger for displaying Génia E-collars and Cosypad®.

- Collars are easy to remove by pulling through the slit, no need to remove the collars in front.

Code	Model
306117	E-collars and Cosypad® hanger

p.75 Find Cosypad®



TRANSCOL

Transparent coloured polypropylene E-collars.

- Quick fastening system.
- Colour-coded according to size.
- Wavy outer edge to reduce frontal impact.
- Engraved anti-scratch lines.
- Black marking.

Supplied by 12 in cardboard boxes.



FUNCOL®

NEW

Transparent colourless polypropylene E-collars with coloured paw prints.

- Quick fastening system.
- Colour-coded according to size.
- Wavy outer edge to reduce frontal impact.
- Engraved anti-scratch lines.
- New sizes available : 17.5 cm, 35 cm and 40 cm.

Supplied by 12 in cardboard boxes.



GREENCOL

Transparent colourless polypropylene E-collars.

- Quick fastening system.
- 80% recycled, 100% recyclable.
- Wavy outer edge to reduce frontal impact.
- Engraved anti-scratch lines.
- Green markings.

Supplied by 12 in cardboard boxes.



NEOCOL®

Transparent colourless polypropylene E-collars with shock-absorbent reflective neoprene outer edge.

- Quick fastening system.
- Colour-coded according to size.
- Lined with comfortable shock-absorbing neoprene, with reflective fabric to better spot the animal at night.
- Engraved anti-scratch lines.
- Reinforced with neoprene lining.
- The collar is well-tolerated by cats because the neoprene is light and absorbs noise.

Supplied by 12 in cardboard boxes.



STANDARD FASTENING SYSTEM

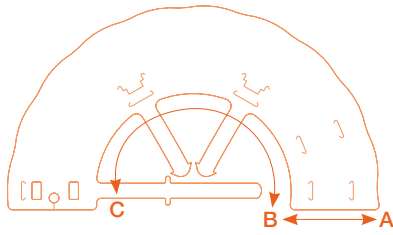

Conventional secure fastening system, with one secure attachment between the collar and the animal, and other individual attachments within the collar.

- 2 to 3 neck size options.
- Protects the head, abdomen and legs.
- Separate tabs on the collar.
- Storage hole to hang collars and select one simply by pulling it down.
- E-collar inks comply with FDA standards, non-toxic for animals.

Code x 12 NECKY	Code x 12 SMOCKY	Size (A-B)	Neck size (B-C)		O/Pack.
			min.	max.	
306000	306400	7.5 cm	25 cm	28 cm	x 30
306002	306402	10 cm	22 cm	28 cm	x 30
306004	306404	12.5 cm	25 cm	33 cm	x 20
306006	306406	15 cm	33 cm	41 cm	x 12
306008	306408	20 cm	37 cm	46 cm	x 8
306010	306410	25 cm	43 cm	52 cm	x 6
306012	306412	30 cm	47 cm	58 cm	x 4
306013	306413	35 cm	54 cm	70 cm	x 3
306014	306414	40 cm	62 cm	80 cm	x 3
306016	306416	Set (2x7 sizes, from 7.5 to 30 cm)			x 4

p.70 [Find E-collar hanger](#)

ASSEMBLY

Place the perforated part on top, with the smooth surface inward.

Slide the large tabs through the selected slits.

Slide them under, then over.

Repeat with the small tabs.

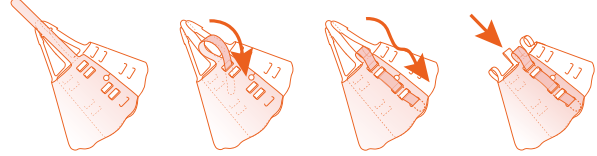

DISASSEMBLY

Pull the tabs out of the slits.



Watch the video version
on our Youtube channel !



NECKY

Transparent colourless polypropylene E-collars.

- Standard fastening system.
- 80% recycled, 100% recyclable.
- Wavy outer edge to reduce frontal impact.
- Engraved anti-scratch lines.
- Green marking.

Supplied by 12 in cardboard boxes.



80 % RECYCLED |
100 % RECYCLABLE



SMOCKY®

Opaque colourless polypropylene E-collars.

- Standard fastening system.
- Wavy outer edge to reduce frontal impact.
- Engraved anti-scratch lines.
- Black marking.

Supplied by 12 in cardboard boxes.



OPAQUE |
E-COLLAR

VELCRO FASTENING SYSTEM

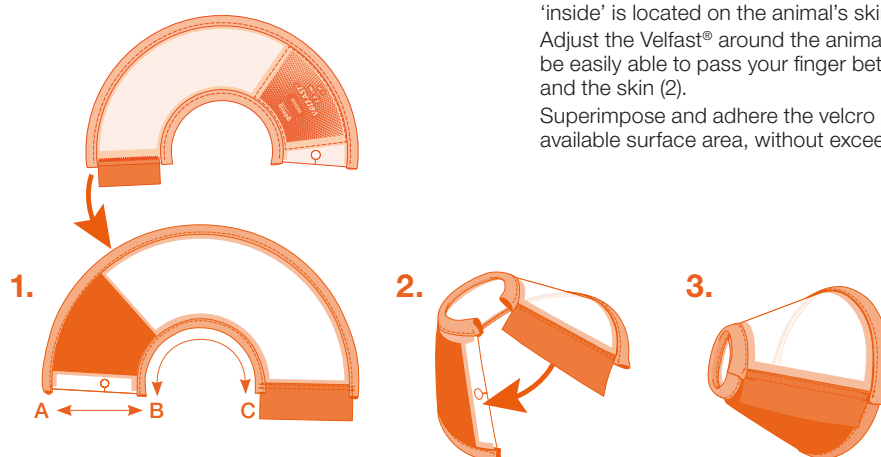

ASSEMBLY

Position the Velfast® such that the marker indicating 'inside' is located on the animal's skin (1).

Adjust the Velfast® around the animal's neck; you should be easily able to pass your finger between the e-collar and the skin (2).

Superimpose and adhere the velcro strips using all available surface area, without exceeding the limit (3).

Code x 12 VELFAST	Size (A-B)	Neck size (B-C)		O/Pack.
		min.	max.	
306450	7,5 cm	14 cm	17 cm	x 10
306452	10 cm	18 cm	23 cm	x 10
306454	12,5 cm	24 cm	29 cm	x 10
306456	15 cm	26 cm	36 cm	x 10
306458	20 cm	31 cm	43 cm	x 10
306460	25 cm	36 cm	50 cm	x 5
306462	30 cm	42 cm	53 cm	x 5
306468	Set (2x7 sizes, from 7.5 to 30 cm)			x 5

Watch the video version
on our website!



VELFAST®

NEW

Transparent colourless polypropylene E-collars with double neoprene edging.

- Flexible, silent peripheral neoprene edging, absorbing impacts and noise. This offers more comfort for the animal and faster adaptation to wearing the E-collar.
- Atraumatic neoprene edging around the neck.
- Simple, quick velcro attachment offering excellent tear resistance.
- Velcro strip adjustment according to neck circumference.
- Engraved anti-scratch lines.
- Reinforced with neoprene lining.
- Colour-coded according to size.
- Available in 7 sizes.

Supplied by 12 in cardboard boxes.



Ultra-quick
fastening



COMFORTABLE | LARGE
ADJUSTMENT AREA

■ COSYPAD® GREEN

Mesh pad anti-bedsores.

Offers comfort, hygiene and ease of cleaning.

It is preferable to grates, underpads, and others bedding.

Its aerated structure keeps animals clean and dry. Cosypad® provides comfort to animals and saves professionals time.

- Reduces the pressure exerted on muscles and joints for optimal comfort and the prevention of bedsores.
- Hygienic: liquids drain under the pad, leaving the animal dry.
- Good aeration, allowing better healing of wounds and better thermoregulation.
- Hypoallergenic material, odourless, antibacterial.
- Very strong, mould-resistant and insulating.
- Washable:
 - in a washing machine at 40 °C with a bleach pellet,
 - with a hose after soaking in a disinfecting solution,
 - use of dryer and spin cycle not recommended.
- Uses:
 - in hospital cages,
 - on examination and surgery tables,
 - during the post-operative recovery stage,
 - in dental scaling (fast drainage of liquids),
 - as anti-fatigue mat for the surgeon.

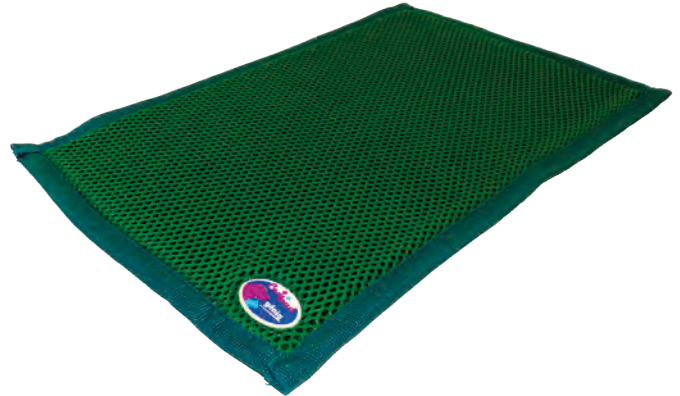

Code	Model	Dimensions	Weight	O/Pack.
327211	S	33 x 50 cm	200 g	x 40
327212	M	39 x 71 cm	382 g	x 40
327213	L	55 x 71 cm	505 g	x 20



■ COSYPAD® NEW GENERATION



A new generation mesh pad made from anti-bedsores material used in hospitals. This new design offers comfort, hygiene and greater resistance.

The new generation Cosypad® meets all the conditions ensuring optimal animal comfort and saves time for animal health professionals (less nursing, fewer underpad changes, reduced use of a heating mat, etc.).

- Ventilated, flexible honeycomb meshing to reduce pressure on muscles and joints.
- Ventilated structure that is ideal for extended hospitalisation, allowing better wound healing and heat regulation.
- Reinforced seams and tough nylon on the edges for better durability.
- Non-slip underside for optimal stability in hospital cages and on surgical and consulting tables.
- Mould-resistant and insulating.
- Suspension eyelet for hanger.
- Hygienic: liquids drain under the pad, leaving the animal dry.
- Does not retain fur.
- Hypoallergenic material, odourless, antibacterial.
- Washable:
 - in a washing machine at 40 °C with a bleach pellet,
 - with a hose after soaking in a disinfecting solution,
 - use of dryer and spin cycle not recommended.
- Uses:
 - in hospital cages,
 - on examination and surgery tables,
 - during the post-operative recovery stage,
 - in dental scaling (fast drainage of liquids),
 - as anti-fatigue mat for the surgeon.

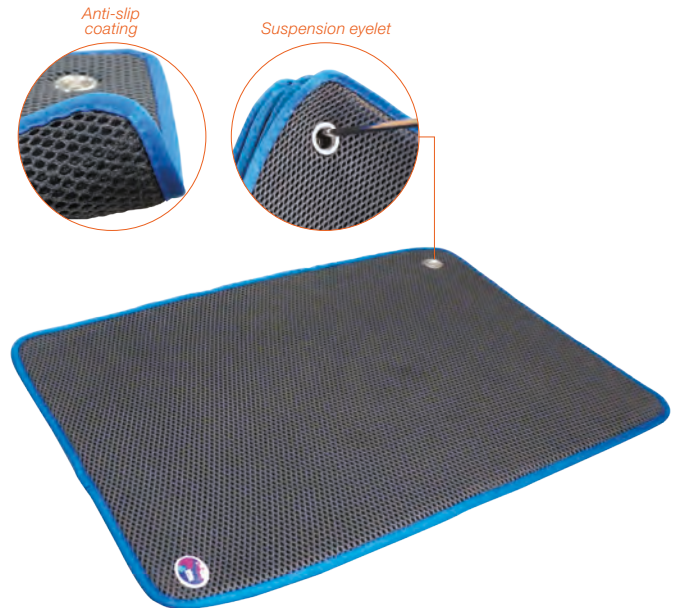

CONTINUOUS SEWING | ROUNDED EDGES

Code	Model	Dimensions	Weight	O/Pack.
327200	T1	33 x 50 cm	200 g	x 40
327201	T2	39 x 71 cm	382 g	x 40
327203	T3	55 x 71 cm	505 g	x 20
327205	T4	60 x 115 cm	884 g	x 20

ACCESSORIES

Code	Model
306117	E-collar and Cosypad® hanger (p.70)



Anti-fatigue mat

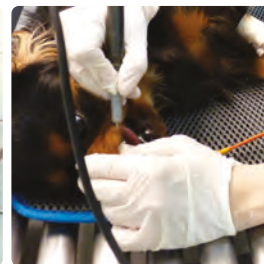

Dental scaling

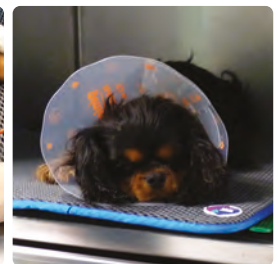

Hospitalization



Watch the video version on our website!



VACUUMAT®

Vacuum immobilization mattress made of sturdy polyurethane material.

- Radiolucent.
- Easy to clean.
- High microbeads capacity to conform to the animal's shape.
- Flexible, comfortable and very sturdy material.
- The vacuum system allows complete immobilization in the desired position, which is ideal for radiology, ultrasound, MRI, CT and surgery.
- Thermal insulation.
- Safety valve, which can maintain vacuum over more than 72 hours.

Supplied by unit with a pump.



Watch the video version on our website!



Code	Dimensions
327302	40 x 60 cm
327304	60 x 100 cm

ACCESSORIES

Code	Model	O/pack.
327306	Pump for VACUUMAT®	x 20



DRYSOFT®

Super absorbent, silky and comfortable pad made of super absorbent gel layer covered with a thin cellulose layer and resting on waterproof and non-skid non-woven layer.

- 5 layers to optimise the absorption of liquids.
- Performing gel to neutralise odors and absorbs 200 to 300 times its mass.
- Antimicrobial protection.
- Fast soaking.
- Does not leak after absorption of the volumes listed.
- Moderately wet after absorption of the required quantities.

Supplied by 25 or 30.

Code	Size	Absorption capacity	Pack.
327050	40 x 60 cm	800 mL	x 30
327052	60 x 60 cm	1 000 mL	x 30
327054	60 x 90 cm	1 900 mL	x 25
327056	60 x 90 cm +	2 500 mL	x 25



INCOMPARABLE PERFORMANCE

ANTIMICROBIAL PROTECTION

FAST ABSORPTION

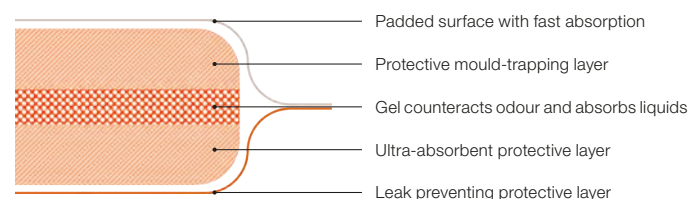

WATER ABSORPTION TEST COMPARISON

GÉNIA (BATCH # 022014 TESTED)			MATTRESS PADS ON MARKET	
Size	Weight	Absorbed volume ¹	Weight	Absorbed volume ¹
40 x 60 cm	36 g	800 ml	38 g	600 ml
60 x 60 cm	66 g	1000 ml	66 g	700 ml
60 x 90 cm	105 g	1900 ml	105 g	1100 ml
60 x 90 cm +	140 g	2500 ml	175 g	2400 ml

¹ Test Protocol: Running water uniformly and gently over pad until the liquid is no longer contained by the mattress pad.



STRAP BAND

Cohesive elastic bandages.

- Self-adhesive, without sticking to the skin or the fur.
- Strong and easy to apply.
- Easy to cut, no scissors needed.
- Starting strip for easy unravelling.

Supplied by 12 or 24.



Red	Green	Blue	Yellow	Black	Dimensions	Pack.	O/pack.
307200	307201	307202	307203	-	5 cm x 4.5 m	x 24	x 12
307206	307207	307208	307209	-	7.5 cm x 4.5 m	x 12	x 16
307212	307213	307214	307215	307216	10 cm x 4.5 m	x 12	x 12

Code	Model	O/pack.
307220	Set of 32 classic bands	x 8
	5 cm x 4.5 m: 2 x 4 x	
	7.5 cm x 4.5 m: 2 x 4 x	
	10 cm x 4.5 m: 2 x 4 x	

STRAP BAND - BITTER TASTE

Cohesive elastic bandages with bitter taste.

- Identical to STRAP BAND.
- To prevent chewing and tearing.
- Contains denatonium benzoate, a bitter taste-repellent agent. This substance is also used to deter ingestion of household products and antifreeze and as a nail polish to prevent nail biting. Denatonium benzoate is considered harmless to the skin*.

*International Journal of Toxicology, vol. 27, no S1, 2008.

Supplied by 12 or 24.



Purple	Dimensions	Pack.	O/pack.
307230	5 cm x 4.5 m	x 24	x 12
307232	7.5 cm x 4.5 m	x 12	x 16
307234	10 cm x 4.5 m	x 12	x 12

Code	Model	O/pack.
307222	Set of 16 bands with bitter taste Each model x 8 (size 5 and 7.5)	x 8

FUN STRAP®

Cohesive elastic bandages with coloured patterns.

- Identical to Strap Band.

Supplied by 12 or 24.



Non-contractual visuals.

Code	Set contents	Dimensions	Pack.
307240	8 bandages of each model	5 cm x 4.5 m	x 24
307241	4 bandages of each model	7.5 cm x 4.5 m	x 12
307242	4 bandages of each model	10 cm x 4.5 m	x 12
307243	Set - 3 bandages of each size and each model	-	x 27



■ EQUIPLAST®

Equine bandage with a thick layer of surgical quality high-density cotton and a tubular non-woven gauze.

- Sterilised with ethylene oxide. (ETO).
- Avoid excessive tension on the limb and distributes the pressure.
- Highly absorbent.
- Protection against impact.
- Distribution of pressure, allowing prevention of sores.
- Adheres lightly, allowing scar tissue to form.
- Promotes healing.
- Adapted to horse and pony anatomy.
- Can be cut to the required dimensions.
- Can be secured with an adhesive badage such as Aderplast® or Strap Band.
- Uses:
 - post-surgical dressings,
 - primary or secondary layers,
 - joint protection (stifle, hock, fetlock),
 - pressure dressings.

Supplied as a 500 g roll in an individual plastic bag. Available in 2 widths.

Code	Dimensions
307280	30 cm x 3.5 m
307282	50 cm x 2 m



HIGHLY
ABSORBENT

■ ADERPLAST®

White adhesive elastic bandage.

- Aerated strip, 100% woven cotton.
- Flexible elastic band for effective tightening.
- Body made from highly adhesive surgical rubber.
- Protection of siliconised paper, low noise, with edging to facilitate removal.
- Good skin tolerance.
- Excellent resistance to repeated movement.

Supplied by 12 or 18. Available in 4 widths.



AERATED STRIP
100% WOVEN COTTON

Code	Dimensions	Pack.
307250	3 cm x 2.5 m	x 12
307252	6 cm x 2.5 m	x 18
307254	8 cm x 2.5 m	x 12
307256	10 cm x 2.5 m	x 12



■ STOCKINETTE

100% stretch cotton stocking, natural colour. Protects the skin under casts.

Abdominal dressings.

Supplied in 25 m rolls in a polyethylene bag.



Code	Length
307020	3 cm
307022	5 cm
307024	7 cm
307026	10 cm
307028	15 cm
307030	20 cm

■ ADERPLAST® ULTRA

NEW

White adhesive elastic bandage with high adhesive strength.

- Aerated strip, 100% woven cotton.
- Highly adhesive, suitable for all types of dressings and bandages.
- Protection of siliconised paper: low noise, does not frighten the animal.
- Easy to peel off from its support thanks to the edges of the siliconised paper.

Supplied by 12. Available in 4 widths.

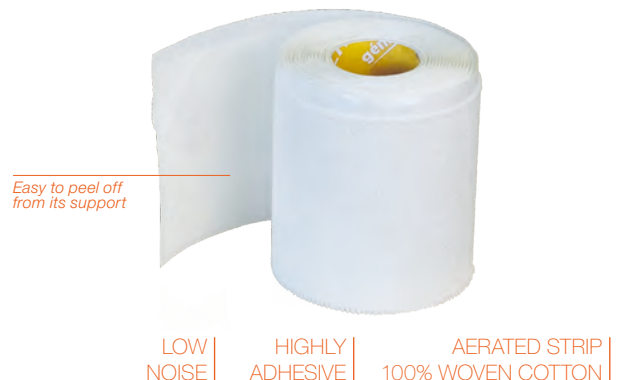

Code	Dimensions	Pack.
307290	3 cm x 2.5 m	x 12
307292	6 cm x 2.5 m	x 12
307294	8 cm x 2.5 m	x 12
307296	10 cm x 2.5 m	x 12



SPLINTS

Concave plastic splints; red, blue or green depending on size; coated with a thick protective foam.

- Very strong material, poly-gloss finish.
- No sharp angles, thick closed-cell protective foam that extends beyond the edges of the splint to protect the animal.
- Can be cut to fit the animal's limb.
- Air holes along the length of the splint allow air to circulate and prevent scar formation.

Supplied by unit or by 12.

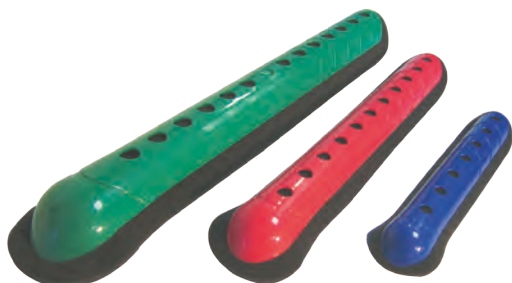

NO SHARP ANGLE | VERY STURDY MATERIAL

Code x 1	Code x 12	Length	O/pack.
307801	307800	20 cm ●	x 24
307806	307805	30 cm ●	x 8
307811	307810	40 cm ●	x 6

FLAT SPLINTS

One aluminium side and one protective soft foam side.

- Easy to cut with Mayo serrated scissors to fit the animal's limb.
- Radiolucent.
- Sturdy, light and atraumatic.
- Ideal for temporary limb immobilization.
- Available in 5 widths.

Supplied by 12.

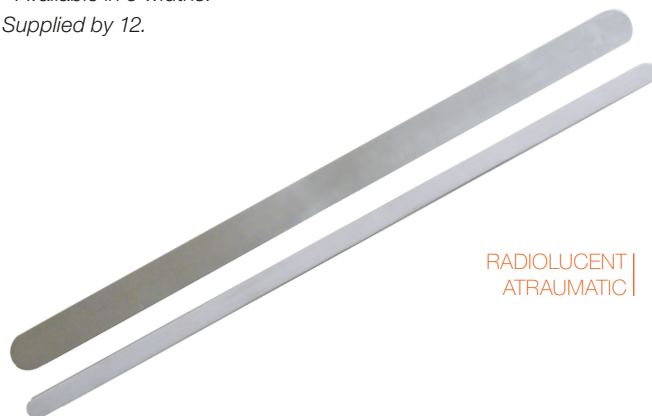

RADIOLUCENT | ATRAUMATIC

Code x 12	Dimensions
307820	2 x 20 cm
307822	2.5 x 30 cm
307824	5 x 40 cm
307826	8 x 45 cm
307828	10 x 45 cm

p.46 Find our Mayo serrated scissors

ROLL SPLINTS

Aluminium roll splint with foam on both sides.

- Easy to cut.
- Cut with Mayo serrated scissors to fit the animal's limb.
- Radiolucent.
- Flexible, atraumatic, easily takes the shape of the limb requiring immobilization.
- Available in 3 widths.

Supplied by 4.





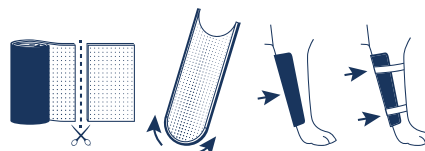
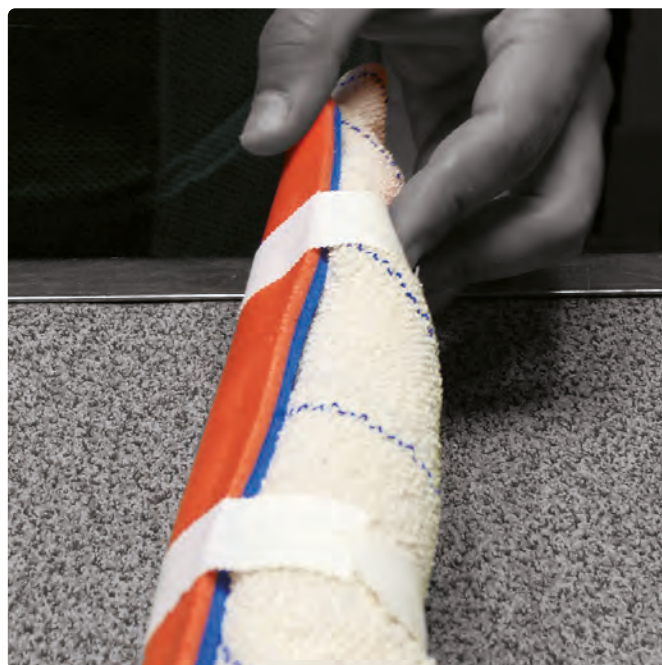

FLEXIBLE | RADIOLUCENT | ATRAUMATIC

Code x 4	Dimensions
307830 ●	4.5 x 25 cm
307832 ●	5.5 x 35 cm
307834 ●	9 x 40 cm

p.47 Find our Mayo serrated scissors



THE CHOICE IS BASED ON THE VETERINARIAN'S CLINICAL ASSESSMENT

	TYPE OF WOUND	DRESSINGS	DRESSING CHANGE
	<p>Non-infected wound. Surgical wound. Healing by first intention. Low exudate wound.</p>	<p>SURGI</p>	<p>When saturated. From every day to every few days.</p>
	<p>Wound in debridement stage. High or moderate exudate and/or cavitory wound.</p>	<p>ALGI <i>Rough side against the wound</i></p>	<p>When saturated. From every day to every few days.</p>
	<p>Wound in debridement stage or in granulation stage. Moderate exudate wound and/or without cavitation.</p>	<p>HYDRO</p>	<p>Every three days on average. Change if discoloured or swollen.</p>
	<p>Wound in granulation stage. Low exudate wound and/or burns.</p>	<p>TULLO</p>	<p>From every day to every few days.</p>
	<p>Wound from debridement to epithelialisation. Medium/high exudate wound Aural hematoma.</p>	<p>SPONGI <i>Foam side against the wound</i></p>	<p>When saturated or every five days.</p>

ANIPLAST® SET

Set of Aniplast® dressings for small and large animals.

Supplied by 10 or 20.

Code	Model	Pack.
327040	Small animals set 4 of each dressing 10 x 10 cm	x 20
327042	Large animals set 2 of each dressing 10 x 20 cm (Surgi, Algi, Tullo) and 20 x 20 cm (Hydro, Spongi)	x 10



p.78 Find our adhesive Aderplast® bandages



■ ANIPLAST® SURGI

Non-adhesive absorbent dressing.

- Non-woven absorbent pad: prevents maceration and infection.
- Micro-perforated polyethylene sheets on each surface limit maceration.

Supplied by 6 or 12.

Code	Dimensions	Pack.	O/pack.
327030	10 x 10 cm	x 12	x 24
327032	10 x 20 cm	x 6	x 24

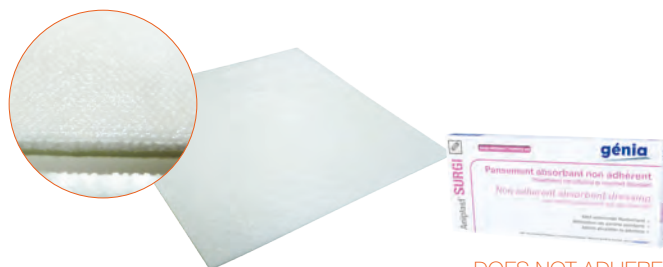

DOES NOT ADHERE
TO THE WOUND

■ ANIPLAST® ALGI

Super absorbent calcium and sodium alginate dressing with silver ions.

- Silver ions with antibacterial properties.
- Forms a protective gel on the wound surface.
- Haemostatic.

Supplied by 6 or 12.

Code	Dimensions	Pack.	O/pack.
327020	10 x 10 cm	x 12	x 24
327022	10 x 20 cm	x 6	x 24



SUPER
ABSORBENT

■ ANIPLAST® HYDRO

Absorbent healing dressing.

- Gelatine-free hydrocolloid layer applied to a polyurethane film to form a gel on the wound surface.
- Maintains a moist and warm environment on the surface of the wound: promotes granulation and epithelialisation along with wound self-debridement.
- Resistant to bacteria.

Supplied by 5 or 10.

Code	Dimensions	Pack.	O/pack.
327014	10 x 10 cm	x 10	x 48
327016	20 x 20 cm	x 5	x 24



HYDROCOLLOID

■ ANIPLAST® TULLO

Tulle gras dressing.

- A 100% cotton absorbent gauze impregnated with white paraffin.
- Made from reticular cotton fabric that allows exudate to drain from the wound; no maceration.
- Pro-inflammatory activity: promotes granulation.

Supplied by 10 or 20.

Code	Dimensions	Pack.	O/pack.
327006	10 x 10 cm	x 20	x 24
327008	10 x 20 cm	x 10	x 24

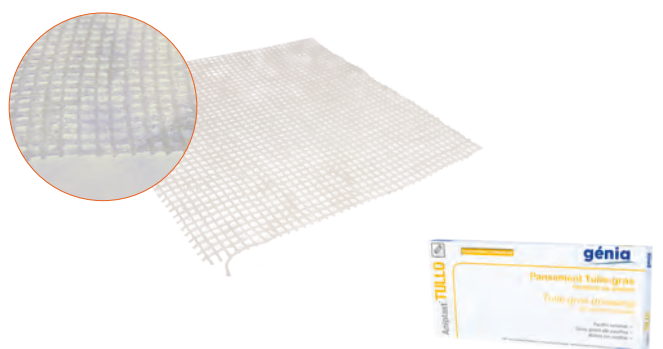

TULLE GRAS

■ ANIPLAST® SPONGI

Super absorbent dressing. Non-adhesive, semi-occlusive foam dressing on a thick water-resistant polyurethane film.

- Permeable to gas and water vapours but resistant to bacteria; limits maceration and infection.
- Keeps the wound surface moist and warm: encourages wound self-debridement, granulation and epithelialisation.

Supplied by 3 or 10.

Code	Dimensions	Pack.	O/pack.
327000	10 x 10 cm	x 10	x 48
327002	20 x 20 cm	x 3	x 24

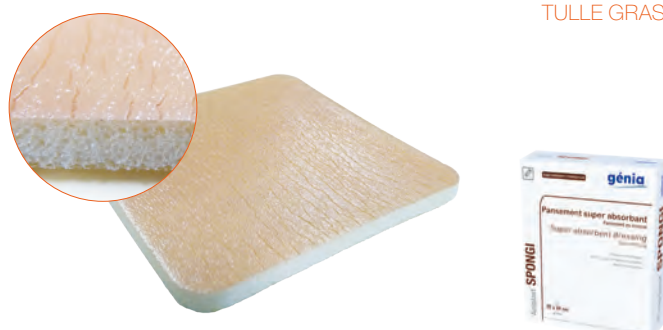

ABSORBS UP TO 50
TIMES ITS WEIGHT

■ CALCIUM ALGINATE DRESSING

Sterile, non-adherent calcium alginate dressing.

- Composition: non-woven pads or strips, calcium and sodium alginate fibres: Marine seaweed extract (brown algae).
- Absorbs wound exudate (up to 20 times its weight).
- Creates a protective gel and moist environment to promote healing.
- Prevents skin maceration.
- Painless and easy removal; doesn't disintegrate.

Supplied by 10.



Code x 10	Dimensions
307072	10 x 10 cm

■ HYDROPHILIC FOAM DRESSING

Hydrophilic polyurethane sterile foam dressing.

- Composition: polyurethane foam (covered with adhesive polyurethane for compression models; adheres to the healthy skin but not to the wound), purified water, surfactant, sodium hydroxide and sulphuric acid.
- Maintains a moist environment promoting wound healing.
- Supports fluid balance.
- Better healing compared to hydrocolloids.
- Maintains its structure.
- Soft and comfortable.

Supplied by 10.



Code x 10	Dimensions
307083	10 x 20 cm

■ HYDROGEL CURAFIL DRESSING

Glycerin-based dressing.

- Composition: glyceryl polymethacrylate, preservative, carbomer, gauze, transparent viscous gel composed of purified water (> 70%).
- Promotes granulation tissue formation in a moist environment protecting skin against maceration.
- Softens and debrides dry necrotic tissue.
- Rehydrates, removes and absorbs fibrin to facilitate removal.
- Neutralises bacterial growth.



Code	Capacity
307087	28 g

■ YLG SENIOR TATTOOING MACHINE

Electric tattooing machine with a 220/12 Volt transformer and foot pedal.

- The device is designed to deliver constant deep penetration of the 6-needle group no matter how thick the skin is, ensuring a lasting tattoo.
- The high vibration frequency provides a continuous line for clearly legible characters. The needle is activated by an electromagnet that ensures the correct power, speed and reliability. This is one of the best machines of the market.

Supplied in a case with a bottle of black ink and 1 replacement multi-needle.

Code	Model	Capacity
227108	Complete machine	-
227110	Tube of 5 replacement multi-needles	-
220900 ●	Tattoo ink	15 mL
220904 ●	Tattoo ink	15 mL
220906 ●	Tattoo ink	125 mL



■ YLG JUNIOR TATTOOING MACHINE

This light, compact tattooing machine was designed for tattooing small animals using a multi-needle or single needle. This device is ideal for tattooing cats (small or delicate tattoos on the ear pinna using the single needle).

- Its rotary motor provides regular oscillations. The device can be battery operated or plugged in, both providing perfect needle penetration. It is powered either by a 230 Volt 50 Hertz wall transformer providing 3 volts of direct current or by 3 AA 1.5 volt batteries (LR6 alkaline).
- This machine has a finger switch at the end of the pen for quick switching on and off and a high degree of comfort. The YLG Junior tattooing machine is simple and durable, requiring maintenance only of the needles and the adjustment bearing.

Supplied in a case with a bottle of black ink, one multi-needle and one single needle.

Code	Model	Capacity
221500	Complete machine	-
A 227110	Tube of 5 replacement multi-needles	-
B 227111	Tube of 5 replacement mono-needles	-
220900 ●	Tattoo ink	15 mL
220904 ●	Tattoo ink	15 mL
220906 ●	Tattoo ink	125 mL



NEW

TIKER®

To safely remove ticks from animal. Efficient and quick ! Suitable thanks to the 2 sizes of spoons in the same product which allow to remove easily all type of ticks.

- Made in Green PE, the TIKER® is eco friendly:
 - the material is biobased and 100% recyclable,
 - the cardboard packaging is 100% recycled, 100% recyclable.
- Fast.
- Painless.
- Hygienic.
- Without leaving the mouth-parts of the tick planted in the skin.
- The spoon allows to hold the tick the time to eliminate it.

Supplied in a cardboard by 24 in a dispenser box. The box contains 8 TIKER® of each color.

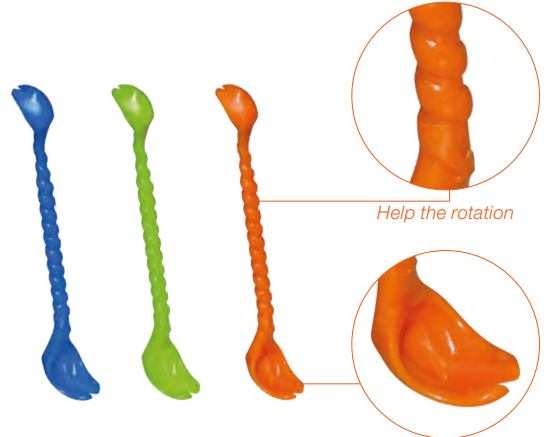

Hold the whole tick without leaving the mouth-parts in the skin

2 IN 1
FOR ALL TYPE OF TICKS

Watch the video version on our website!

Code x 24	Model
191061	Tiker®

I'm green™
Plastic
98% Biobased
Verified by ASTM D6866

Made in Green PE,
biobased material 100% recyclable.
100% recycled packaging!



■ PILL APPLICATOR

PVC pill applicator with flexible tip. Secured.

- Useful to administer pills to cats and small dogs.
- Can be used with just one hand.
- Waterproof. Add water to promote swallowing if needed.
- Atraumatic soft tip.

Supplied by 12 in a dispenser box.

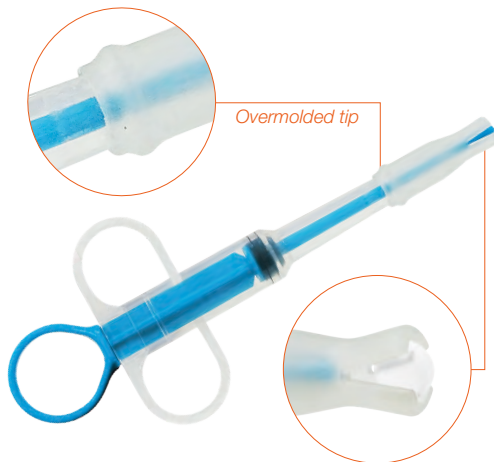

CAN BE USED WITH JUST ONE HAND | ADD WATER IF NEEDED



Code x 12	Model
227230	Pill applicator



■ TABLET CRUSHING CUPS

Compartmented plastic cup for cutting, crushing and storing tablets.



Code	Diameter	Height
227086	40 mm	64 mm

Outer packaging:
master case of 50 units

■ BOTTLE TEATS

Non-perforated, natural latex teats for kitten and puppy that fit on bottle necks.
Certified 93/11/CE.

Supplied in bulk.



	Code	Model
A	227021	Kitten
B	227022	Puppy

DIGIFLASH

Digital thermometer for small and large animals.

- **Flexible** tip, length 7 cm.
- Temperature measurement in **5 seconds**.
 - Recalls the last 5 values.
 - Temperature range: 32 to 43 °C / 90 to 110 °F.
 - Accuracy: 0.1 °C / 0.18 °F.
 - Alarm at end of measurement.
- Low battery symbol display.
- Auto power-off.
- Waterproof.
- Shock-resistant.

Supplied in a transparent polycarbonate box with an additional battery.



FLEXIBLE TIP | FAST READING | 5 SECONDS

Code	Length	Tip length
227972	15,5 cm	7 cm

Outer packaging:
master case of 12 and 240 units

DIGIFIX

Digital thermometer for small and large animals.

- Thin monobloc **rigid** tip, length 7.5 cm.
- Temperature measurement in **10 seconds**.
 - Recalls the last 5 values.
 - Temperature range: 32 to 43°C/90 to 110°F.
 - Accuracy 0.1°C/0.18°F.
 - Alarm at end of measurement.
- Low battery symbol display.
- Auto power-off.
- Waterproof.
- Shock-resistant.

Supplied in a transparent polycarbonate box with an additional battery.



RIGID TIP

Code	Length	Tip length
227978	15,5 cm	7,5 cm

Outer packaging:
master case of 12 and 240 units

DIGIVET

Digital thermometer for small animals.

- **Flexible** tip, length 5 cm.
- Temperature measurement in **10 seconds**.
 - Recalls the last 5 values.
 - Temperature range: 32 to 42 °C / 90 to 108 °F.
 - Accuracy: 0.1 °C / 0.18 °F.
 - Alarm at the end of measurement.
- Low battery indicator symbol.
- Auto power-off.
- Waterproof.
- Shock-resistant.

Supplied in a transparent polycarbonate box with an additional battery.



FLEXIBLE TIP | FAST READING | 10 SECONDS

Code	Length	Tip length
227970	12,5 cm	5 cm

Outer packaging:
master case of 12 and 240 units



CAPTURE

IMMOBILISATION EQUIPMENT

Projectors

Blowpipes	89
Pneumatic projectors	90
Gas projectors	92
Accessories for gaz projectors	94
Powder projectors	96
Accessories for powder projectors	97
Accessories for all projectors	98

Syringes and cannulas

11 mm syringes and cannulas	100
13 mm syringes and cannulas	102
Accessories for syringes	104
Disposable 13 mm syringes	105
Pole syringes	106

CAPTURE EQUIPMENT

Poles and tongs

Capture poles	107
Clinical poles	109

Traps, transportation

Traps	110
Kennels	112
Stretcher	114

Capture tongs and landing net

Capture tongs for cats	115
landing net	116

Reptiles 117

Capture gloves 120

DISTINJECT PROJECTORS

PROJECTOR SELECTION GUIDE

ANIMALS	DISTANCE	TYPE OF PROJECTOR									
		BLOWPIPES		GAS PROJECTORS						POWDER PROJECTORS	
		MINI-JECT	DISTINJECT	MOD. 45 STANDARD	MOD.45 SPECIAL	MOD. 35N	MOD. 50N	MOD. 70	MOD. 72	MOD. 30N	MOD. 60N
<i>Cattle, deer, cat, dog, buck, llama, sheep, pig</i>	L < 20 m	•	•	•	•	•	•	•	•	•	•
<i>Wild boar, elephant, grizzly, bear</i>					•	•	•	•	•	•	•
<i>Cattle, deer, cat, dog, buck, grizzly, llama, sheep, bear, pig, wild boar, elephant</i>	20 < L < 40 m					•	•	•	•		•
<i>Bison, mountain goat, gazelle, wildebeest, kangaroo, leopard, lion, wolf, sheep, fox, reindeer, tiger</i>	40 < L < 50 m						•	•	•		•
<i>Giraffe, bison, badger, horse, deer, elk, cheetah, oryx, cougar, monkey, zebra</i>	L > 50 m							•	•		•



HYPODERMIC PROJECTOR | FOR TELEANESTHESIA |

For more information on our hypodermic projector range, request our *Distinfect Projector* brochure or download it on our website.



MINI-JECT BLOWPIPE - 11 MM

Polycarbonate blowpipe for capture of animals at a short distance.

- Range: **1 to 7 m** (depending on the syringe type), ideal for animals with short flight distance.
- For use with **11 mm diameter syringes** (p.100).
- Syringes fitted with wool stabilisers (p.100).
- The rubber end-piece facilitates projection. **A**

Supplied with full standard equipment*, in a cardboard box.

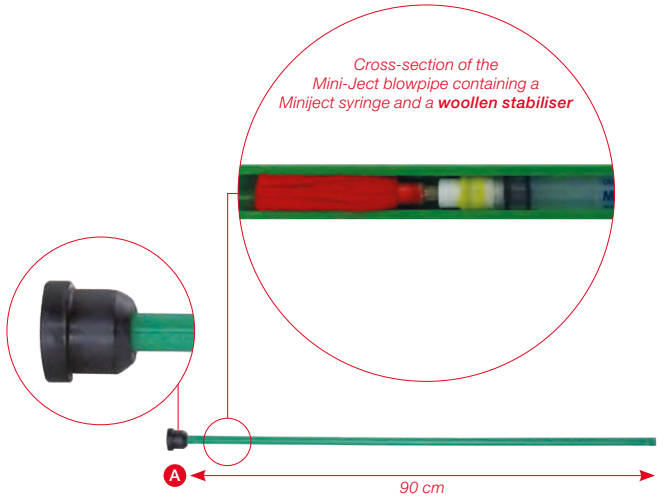

EASY TO USE

DISTINJECT BLOWPIPE - 16 MM WITH EXTENSION

Polycarbonate blowpipe with extension for capture of animals at a short to medium distance.

- Range: **up to 15 m** depending on the training of the shooter. Up to 7 m without extension.
- For use with **11 mm diameter syringes** (p.100).
- Syringes fitted with PVC stabilisers (p.100).
- The rubber end-piece facilitates projection. **B**
- Easy to assemble.
- Supplied in a rigid lightweight carrying case with shoulder strap.

Supplied with full standard equipment.*

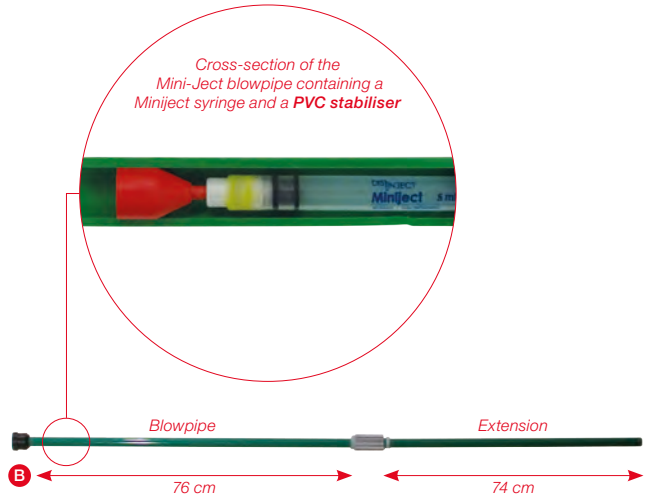

LONG RANGE



Code	Model	Weight	Length	Calibre	Range
192030	Mini-ject blowpipe 11 mm with full equipment	120 g	90 cm	11 mm	1 to 7 m
192031	End-piece for 11 mm blowpipe A				

Code	Model	Weight with/without extension	Length with/without extension	Calibre	Range
192036	Distinject blowpipe 16 mm with extension and full equipment	450 g / 250 g	150 cm / 76 cm	16 mm	15 m
192037	End-piece for 16 mm blowpipe B				

*For full range, request our Distinject Projector brochure or download it on our website.



■ PNEUMATIC PROJECTOR 45 DELTA STANDARD, 11 MM SYRINGES

Pneumatic projector made entirely from aluminum, for capture of animals at a short distance.

- Energy less than 3.5 Joules.
- Range: **up to 4 m** (depending on the syringe type).
- For use only with **11 mm diameter syringes** (p.100).
- Syringes fitted with wool stabilisers.
- Barrel fixed with bayonet attachment.
- Easy to use.
- Transformable into 45 Delta Special model by adding a pressure chamber with gauge **A** and CO₂ capsule holder **B** with pocket charger **C**.
- **Treated 11 mm steel barrel**, length 35 cm.
- Aiming system incorporated to improve precision (front and rear sight).

Supplied with full 11 mm equipment.*

Code	Model	Weight	Length	Calibre	Range
192032	45 Delta Standard pneumatic projector with full equipment	450 g	35 cm	11 mm	4 m



*For full range, request our *Distinject Projector* brochure or download it on our website.

■ PNEUMATIC PROJECTOR 45 DELTA SPECIAL, 11 MM SYRINGES

Pneumatic projector made entirely from aluminum, for capture of animals at a short and medium distance.

- Energy less than 6 Joules.
- Range: **up to 20 m** (depending on the syringe type).
- For use only with **11 mm diameter syringes** (p.100).
- Syringes fitted with wool stabilisers.
- Barrel fixed with bayonet attachment.
- Easy to use.
- **Treated 11 mm steel barrel**, length 35 cm.
- Aiming system incorporated to improve precision (front and rear sight).
- **65 mL pressure chamber** with gauge. **A**
- **Pocket charger for CO₂ gas C** (fitted with a 16 g CO₂ capsule **B** holder and an 8 g reducer for holding 8 g CO₂ capsules).

Supplied with full 11 mm equipment.*

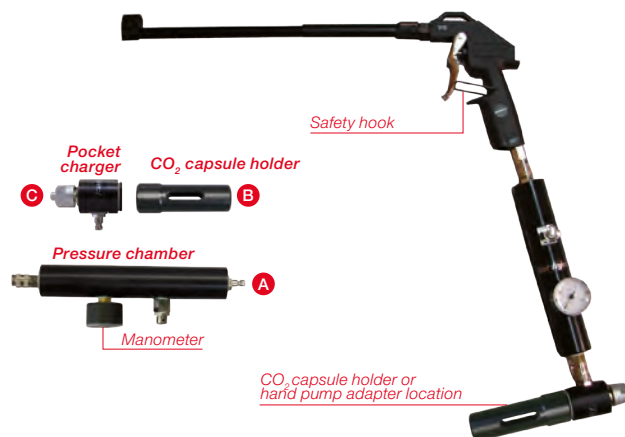

Code	Model	Weight	Length	Calibre	Range	Chamber volume
192034	45 Delta Special pneumatic projector with full equipment	800 g	35 cm	11 mm	20 m	65 mL



p.94 [Find our pneumatic projector accessories](#)

GAS PROJECTORS

GAS PROJECTOR'S SHOOTING DISTANCE

	SYRINGE MODEL		GAS PROJECTOR MODEL			
			35N	50N	70	72
STRAIGHT SHOT 	MINIJECT	1 mL, 2 mL	30 m	30 m	40 m	40 m
		3 mL, 5 mL	30 m	30 m	40 m	40 m
	EASY	3 mL	30 m	40 m	40 m	40 m
		5 mL	20 m	30 m	40 m	30 m
	SOFTY	3.8 mL	20 m	30 m	40 m	30 m
	SPEEDY	3.5 mL	20 m	30 m	40 m	40 m
	FLIP	1 mL	30 m	30 m	40 m	40 m
	ALUMINUM	1 mL, 2 mL	20 m	30 m	40 m	40 m
		3 mL, 4 mL	20 m	30 m	40 m	40 m
		5 mL	20 m	30 m	40 m	40 m
		7 mL	10 m	20 m	30 m	30 m
		10 mL	10 m	20 m	30 m	30 m
		15 mL	10 m	20 m	30 m	30 m
	CURVED SHOT 	MINIJECT	1 mL, 2 mL	30 m	20 to 40 m	20 to 40 m
3 mL, 5 mL			20 m	20 to 40 m	20 to 40 m	20 to 40 m
EASY		3 mL	30 m	20 to 50 m	20 to 40 m	20 to 40 m
		5 mL	20 m	20 to 40 m	20 to 40 m	20 to 40 m
SOFTY		3.8 mL	20 m	20 to 40 m	20 to 40 m	20 to 40 m
SPEEDY		3.5 mL	20 m	20 to 40 m	20 to 40 m	20 to 40 m
FLIP		1 mL	30 m	20 to 30 m	20 to 40 m	20 to 40 m
ALUMINUM		1 mL, 2 mL	20 m	20 to 50 m	20 to 60 m	20 to 40 m
		3 mL, 4 mL	20 m	20 to 40 m	20 to 60 m	20 to 40 m
		5 mL	20 m	20 to 40 m	20 to 60 m	20 to 40 m
		7 mL	20 m	20 to 40 m	20 to 50 m	20 to 40 m
		10 mL	10 m	20 to 30 m	20 to 50 m	20 to 40 m
		15 mL	10 m	20 to 30 m	20 to 40 m	20 to 40 m

Values given as an indication only.
Shots performed in a shooting tunnel; Shots fired in a shooting tunnel. Distances may vary depending on the environment.
Aim from less than 30 metres for an optimal shot.



■ GAS PROJECTOR MODEL 35N, 11/13 MM SYRINGES

Small gas projector model for all situations, allowing long-distance shots up to 30 m.

- Energy 7.5 Joules.
 - Fast pressure adjustment for a range **up to 30 m**, depending on the syringe type. The recommended range is 20 m (see firing range p.91).
 - Versatile: accepts all commercially available 11 mm and 13 mm syringes.
 - **13 mm treated steel barrel**, length 37.5 cm, with sight (p.95) for **13 mm diameter syringes** (anodised aluminum syringes p.102, Speedy and Flip p.105).
 - **11 mm reducer for barrel**, length 38.5 cm (p.95) for **11 mm diameter syringes** (p.100).
 - Very safe.
 - Easy to use.
 - Standard prismatic rail for mounting various additional aiming systems except laser rangefinder (p.98).
 - Safety lock system with bayonet-fitting indicator light (chamber plug 17.5 mm diameter p.95) for inserting and positioning syringes.
 - Basic rear sight included.
 - Pressure gauge visible within the field of view.
 - CO₂ 16 g capsule holders and reducer for 8 g.
- Supplied with full standard 11 mm equipment.*

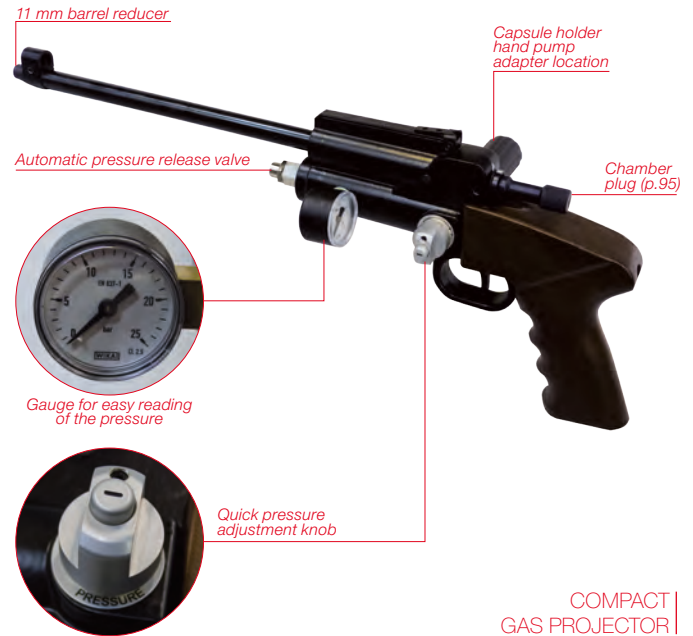

COMPACT
GAS PROJECTOR

Code	Model	Weight	Length	Calibre	Range	Chamber volume
192008	Gas projector model 35N with full equipment	1.6 kg	54 cm	11 and 13 mm	30 m	65 mL

Watch the video version on our Youtube channel !



*For full range, request our Distinject Projector brochure or download it on our website.

■ GAS PROJECTOR MODEL 50N, 11/13 MM SYRINGES

A versatile gas projector model developed for all situations, enabling long range shots up to 50 m. Used worldwide for the capture of all types of animals.

- Energy 9.2 Joules.
 - Fast pressure adjustment for a range **up to 50 m**, depending on the syringe type. The recommended range is 20-30 m (see firing range p.91).
 - Versatile: accepts all commercially available 11 mm and 13 mm syringes.
 - **13 mm treated steel barrel**, length 75 cm, with sight (p.95) for **13 mm diameter syringes** (anodised aluminum syringes p.102, Speedy and Flip p.105).
 - **11 mm aluminum reducer for barrel**, length 76.5 cm (p.95) for **11 mm diameter syringes** (p.100).
 - Prismatic rail for mounting various additional aiming systems (p.98).
 - Safety lock system with bayonet-fitting indicator light (chamber plug 17.5 mm diameter p.95) for inserting and positioning syringes.
 - Removable graduated rear sight for greater shooting accuracy (p.98v).
 - Pressure gauge visible within the field of view.
 - CO₂ 16 g capsule holders and reducer for 8 g.
- Supplied with full standard 13 mm equipment.*

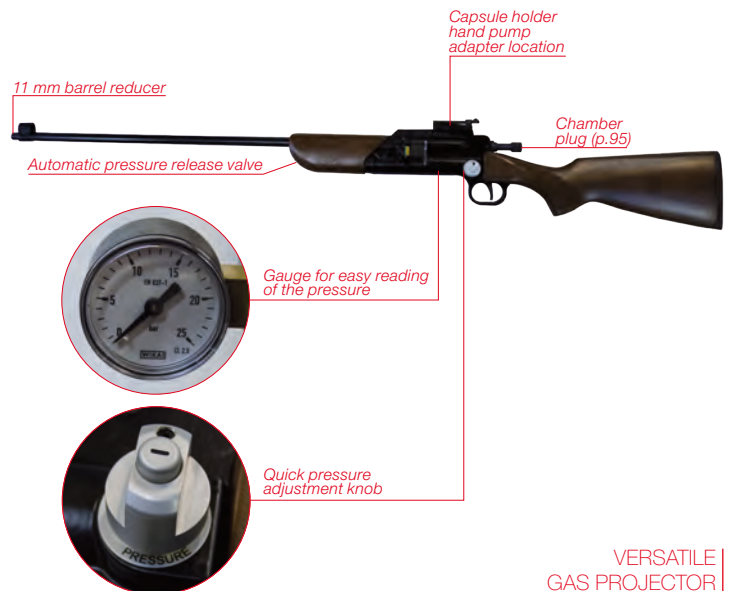

VERSATILE
GAS PROJECTOR

Code	Model	Weight	Length	Calibre	Range	Chamber volume
192020	Gas projector model 50N with full equipment	2.6 kg	118 cm	11 and 13 mm	50 m	105 mL

Watch the video version on our Youtube channel !



■ GAS PROJECTOR MODEL 70, 11/13MM SYRINGES

Top of the line gas projector, allowing long-distance shots up to 60 m.

- Energy 9.8 Joules.
- Fast pressure adjustment for a range **up to 60 m**, depending on the syringe type. The recommended range is 30-40 m (see firing range p.91).
- Versatile: accepts all commercially available 11 mm and 13 mm syringes.
- **13 mm treated steel barrel**, length 75 cm, with sight (p.95) for **13 mm diameter syringes** (anodised aluminum syringes p.102, Speedy and Flip p.105).
- **11 mm reducer for barrel**, length 76.5 cm (p.95) for **11 mm diameter syringes** (p.100).
- Trigger with safety button.
- Prismatic rail for mounting various additional aiming systems except laser rangefinder (p.98).
- Safety lock system with bayonet-fitting indicator light (chamber plug 15.5 mm diameter p.95) for inserting and positioning syringes.
- Removable graduated rear sight for greater shooting accuracy (p.98).
- Pressure gauge visible within the field of view.
- CO₂ 16 g capsule holders and reducer for 8 g.
- After sales service: carried out exclusively in the factory (including seal replacement).

Supplied with full standard 11 mm equipment.*



HIGH-END
GAS PROJECTOR

Code	Model	Weight	Length	Calibre	Range	Chamber volume
192000	Gas projector model 70 with full equipment	3.1 kg	115 cm	11 and 13 mm	60 m	160 mL

*For full range, request our *Distinfect Projector* brochure or download it on our website.

■ GAS PROJECTOR MODEL 72, 11/13MM SYRINGES

Folding gas projector, allowing long-distance shots up to 40 m.

- Energy 9.8 Joules.
- Quick pressure adjustment, **up to 40 m** when fitted with a 50 cm barrel depending on the syringe type. The recommended range is 30-40 m (see firing range p.91). The range can be increased up to **60 m** when fitted with a 75 cm barrel (on request, p.95).
- Versatile: accepts all commercially available 11 mm and 13 mm syringes.
- **13 mm treated steel barrel**, length 50 cm, with sight (p.95) for **13 mm diameter syringes** (anodised aluminum syringes p.102, Speedy and Flip p.105).
- **11 mm aluminum reducer for barrel**, length 51.5 cm (P.95) for **11 mm diameter syringes** (p.100).
- Trigger with safety button.
- Easy to transport.
- Extendible cross with jaw adjustment.
- Prismatic rail for mounting various additional aiming systems (p.98).
- Safety lock system (chamber plug 15.5 mm diameter p.95) for inserting and positioning syringes.
- Removable graduated rear sight for greater shooting accuracy (p.98).
- Pressure gauge visible within the field of view.
- CO₂ 16 g capsule holders and reducer for 8 g.
- After sales service: carried out exclusively in the factory (including seal replacement).

Supplied with full standard 11 mm equipment.*

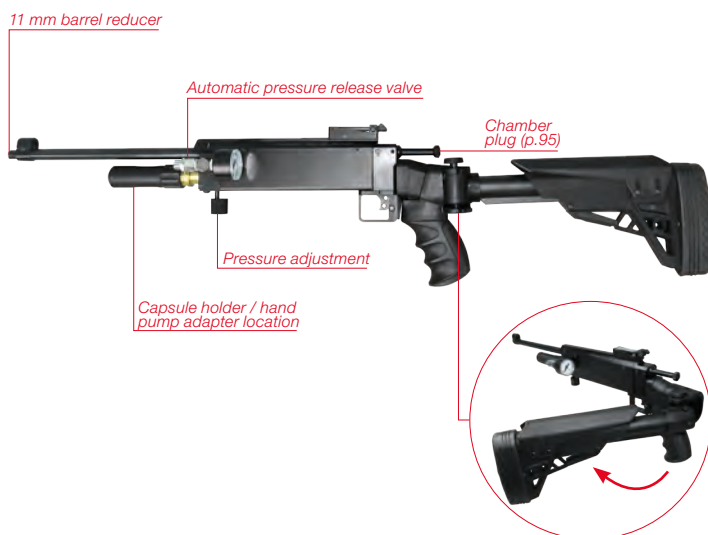

FOLDING
GAS PROJECTOR

Code	Model	Weight	Length	Calibre	Range	Chamber volume
192004	Gas projector model 72 with full equipment	2.9 kg	61 cm folded / 96 cm open	11 and 13 mm	40 m	160 mL



■ PRESSURE CHAMBER FOR MODEL 45 DELTA SPECIAL

Chamber with pressure gauge for quick pressure testing (see model 45 Delta Special 192034 p.90).

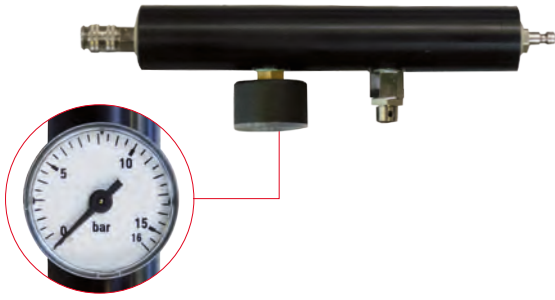

Code	Model
192068	Pressure chamber for model 45 Delta Special

[p.90 Find our pneumatic projector 45 Delta Special](#)

■ POCKET CO₂ GAS CHARGER FOR MODEL 45 DELTA SPECIAL

Supplied complete with pocket charger equipped with a CO₂ capsule holder 16g and with its reducer 8g (see model 45 Delta Special 192034 p.90).

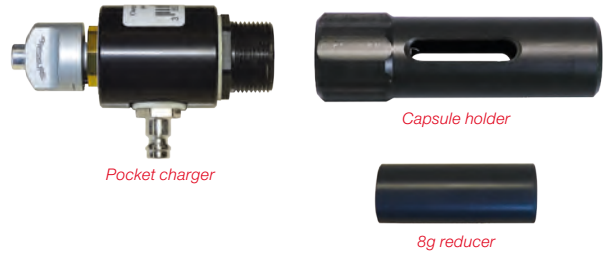

Code	Model
192066	CO ₂ gas pocket charger, for model 45 Delta Special with 16 g capsule holder and 8 g reducer

[p.90 Find our pneumatic projector 45 Delta Special](#)

■ CAPSULE HOLDER

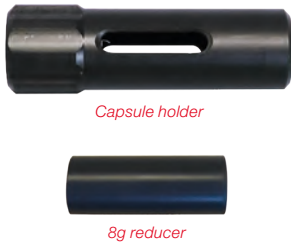

Code	Model
192345	Reducer, 8 g only
192347	CO ₂ capsule holder, 16 g only

■ CO₂ CAPSULE

Supplied in box of 10 units.



Code x 10	Model
192344	CO ₂ capsule 8 g (6 to 8 shots)
192346	CO ₂ capsule 16 g (8 to 16 shots)
192348	CO ₂ capsule 12 g (8 to 16 shots), for discontinued model 55 only

PROJECTOR BARRELS

Interchangeable barrels with sight.



Code	Model	Diameter	Length
192359	45 Delta Standard and Special	11 mm	35 cm
192358	Optional 45 Delta Special	11 mm	70 cm
192361	35N	13 mm	37.5 cm
192353	72	13 mm	50 cm
192352	Optional model 50N/70 or 72	13 mm	75 cm

[p.90 Find our Delta pneumatic projectors](#)

[p.92 Find our gas projectors](#)

REDUCER BARRELS

11 mm diameter aluminum reducer for barrels, to reduce the diameter from 13 mm to 11 mm.



35N reducer

Code	Model	Diameter	Length
192351	35N	11 mm	39 cm
192357	72	11 mm	51.5 cm
192350	Optional model 50N/70 or 72	11 mm	76.5 cm

[p.92 Find our gas projectors](#)

CHAMBER PLUG



	Code	Model	Diameter	Diamètre
A	192880	Chamber plug for models 35N and 50N	17.5 mm	17,5 mm
B	192886	Chamber plug for models 70 and 72	15.5 mm	15,5 mm
A	192895	Plug seal (x3) for models 35N and 50N	-	-
B	192896	Plug seal (x3) for models 70 and 72	-	-

MAINTENANCE OF GAS PROJECTOR* CONTROLS AND TESTS

This package includes:

- change of all the joints and springs,
- pressure resistance tests,
- firing tests,
- cleaning of the projector,
- return of the device.

A quote will be provided for all other repairs.

**Products: 35N, 50N, 70 and 72 gas projectors.*

Code	Model
192990	Gas projector maintenance package.



POWDER PROJECTOR MODEL 30N, 13 MM SYRINGES

Small powder projector model for all situations, allowing medium-distance shots.

- Energy 5 to 12 joules depending on the percussion caps.
- Range: **up to 20 m** (depending on the syringe type).
- **13 mm treated steel fixed barrel**, length 24 cm, with sight (p.95), for **13 mm diameter syringes** (anodised aluminum syringes p.102, Speedy and Flip p.105).
- Easy to use.
- Very safe.
- Fixed, precision, fluorescent rear sight, factory set.
- Short percussion cap holder (p.97).

Supplied individually with full standard 13 mm equipment.*



COMPACT
POWDER PROJECTOR

Code	Model	Weight	Length	Calibre	Range
192012	Powder projector model 30N with full equipment	0.7 kg	39 cm	13 mm	20 m

POWDER PROJECTOR MODEL 60N, 13 MM SYRINGES

Durable and reliable powder projector model, easy to use, allowing medium and long distance shots.

- Energy 5 to 18 joules depending on the percussion caps.
- Range: **up to 60 m** (depending on the syringe type).
- **13 mm treated steel fixed barrel**, length 64 cm, with sight (p.95), for **13 mm diameter syringes** (anodised aluminum syringes p.102, Speedy and Flip p.105).
- Easy to use.
- Very safe.
- Prismatic rail for mounting various additional aiming systems except laser rangefinder (p.98).
- Removable graduated rear sight for greater shooting accuracy (p.98).
- Long percussion cap holder (p.97).

Supplied with full standard 13 mm equipment.*



IDEAL FOR
LONG DISTANCES | DURABLE AND RELIABLE
POWDER PROJECTOR

Code	Model	Weight	Length	Calibre	Range
192016	Powder projector model 60N with full equipment	2.6 kg	115 cm	13 mm	60 m

*For full range, request our *Distinjet Projector brochure* or download it on our website.

QUICK AND EASY TO USE

- 1) LOAD A SYRINGE.
- 2) POSITION THE PERCUSSION CAP HOLDER IN THE PROJECTOR.
- 3) LOAD THE APPROPRIATE PERCUSSION CAP.
- 4) CLOSE, COCK AND FIRE.

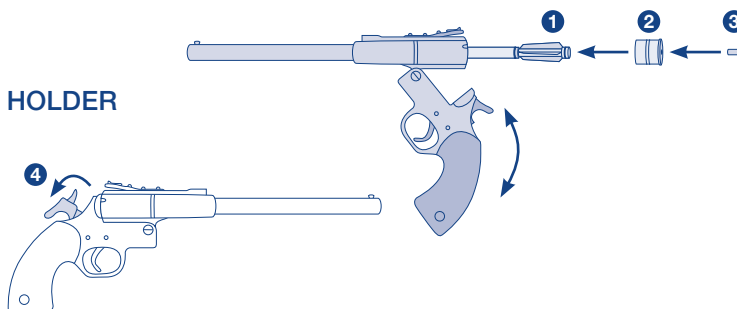

PERCUSSION CAP SELECTION GUIDE

PERCUSSION CAPS	SYRINGES	RANGE	0 m	10 m	20 m	30 m	40 m	50 m	60 m +	
30N	192296 ● Aluminium	5-25 m	15 mL 7 mL 1 mL							
	Speedy	1-15 m	SPEEDY							
	192300 ● Aluminium	10-20 m		15 mL 7 mL 1 mL						
	Speedy	12-20 m		SPEEDY						
	Flip	12-25 m		FLIP						
60N	192298 ● Aluminium	5-25 m	15 mL 7 mL 1 mL							
	Speedy	5-30 m	SPEEDY							
	192306 ● Aluminium	20-35 m		15 mL 7 mL 1 mL						
	Speedy	25-40 m		SPEEDY						
	192302 ● Aluminium	30-50 m			15 mL 7 mL 1 mL					
	192304 ● Aluminium	45-60 m				15 mL 7 mL 1 mL				

Recommended firing distance for an optimal shot: between 15 and 30 m.

PERCUSSION CAPS

Box of 20 percussion caps for powder projector (30N and 60N models).



Code x 20	Model	Range*
192296 ●	Projector model 30N	1/15 m
192300 ●	Projector model 30N	10/25 m
192298 ●	Projector model 60N	5/30 m
192306 ●	Projector model 60N	20/40 m
192302 ●	Projector model 60N	30/50 m
192304 ●	Projector model 60N	45/60 m

*Depending on the syringes used.

PERCUSSION CAP HOLDER

Percussion cap holder for projector models 30N (discontinued model 60) or 60N.

- Clean and lubricate the seal before each use.

Supplied with a pack of seals.



	Code	Model	Diameter	Length
A	192324	Long percussion cap holder for projector model 60N	14.3 mm	80 mm
B	192326	Short percussion cap holder for projector model 30N or discontinued model 60	18.75 mm	25 mm

ACCESSORIES

	Code x3	Model
B	192888	Pack of short percussion cap holder seals
A	192890	Pack of long percussion cap holder seals

CLEANING KIT

Cleaning kit for models 30N and 60N.

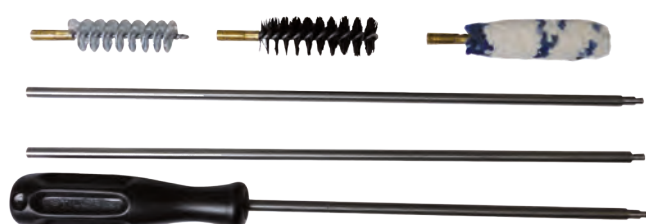

Code	Model
192332	Cleaning kit for 30N and 60N models (with case)

CARTRIDGE POSITIONER AND EJECTOR

Dual function:

- Positioner for 11 mm syringe used with Delta models.
- Cartridge ejector for projector models 30N and 60N.



Code	Model
192336	Cartridge positioner and ejector



PRECISION GRADUATED REAR SIGHT

Mechanical viewfinders allowing increased shot accuracy by alignment of the aiming system with the sight.



Code	Model
192048	Precision rear sight for model 30N
A 192050	Precision rear sight for model 35N/50N/70/72/60N

TELESCOPIC SIGHT 4X32

Optical sight for magnifying the target to facilitate aiming. Replaces the sight and precision rear sight.

- Compatible with gas and powder models.



FACTORY ADJUSTABLE
TO MATCH PROJECTOR

Code	Model
192052	Telescopic sight 4x32 with rail (mounting additional)
192053	Mounted on projector - on request

RED DOT VIEWFINDER

Optical viewfinder projecting a bright dot (crosshairs) on a lens in front of the shooter's eye. Removes the need to align the targeting components for faster aiming.



Side view

Front view

Code	Model
192062	Red dot viewfinder (mounting additional)
192053	Mounting on projector: on request

LASER POINTER

Optical viewfinder with a beam that illuminates the target with a bright dot. Beam visible in broad daylight up to 25 m, in bright sunlight up to 15 m and in twilight up to 60 m.

- Factory assembly highly recommended.



ON
DEMAND

Code	Model
192064	Laser pointer (mounting additional)
192053	Mounting on projector: on request

LASER RANGEFINDER

Electronic viewfinder allowing target distance to be calculated. Facilitates aiming even at very long distance. Range from 10 m. Handheld.

- Available on demand.



*Product may differ from image.

Code	Model
192054	Laser rangefinder - From 10 m

SYRINGES SELECTION GUIDE

REUSABLE NYLON SYRINGES - 11 MM

11 mm diameter hypodermic syringes, for use with 11 mm calibre blowpipes, Delta models and gas projectors.

STABILISERS (P.100)



PVC
Short distance



WOOL
Short to medium distance



WEIGHT (p.101)

required for long distance shooting

SYRINGE BARRELS (P.100)



Watch the presentation of Miniject syringe on our Youtube channel !



CANNULAS (P.101)



SMOOTH CANNULA
Ø 1.1 & 1.3 mm



SMOOTH CANNULA
Ø 1.6 & 2.1 mm



CANNULA WITH BARB
Limits the risk that the syringe will drop before delivering the product. Traumatic.



CANNULA WITH FLANGE
Limits the risk that the syringe will drop before delivering the product. Slightly traumatic.



PRACTICE CANNULA

REUSABLE ALUMINUM SYRINGES - 13 MM

13 mm diameter hypodermic syringes, for use with 13 mm calibre gas projectors or powder projectors.

STABILISERS (P.102)



YELLOW PLASTIC
Long distance

Do not use with orange and white caps

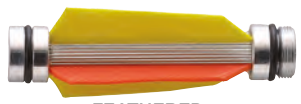

FEATHERED
Long distance



WOOL
Short distance
Gas projectors only

SYRINGE BARRELS (P.102)



Watch the presentation of aluminum syringe on our Youtube channel !



CANNULAS (P.103)



SMOOTH CANNULA



CANNULA WITH BARB
Limits the risk that the syringe will drop before delivering the product. Traumatic.

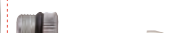

CANNULA WITH FLANGE
Limits the risk that the syringe will drop before delivering the product. Slightly traumatic.



LARGE ANIMAL CANNULA



CANNULA WITH BRAKE



PRACTICE CANNULA

DISPOSABLE NYLON SYRINGES - 13 MM

Automatic Speedy and Flip syringes, **disposable**, with cannula, for all 13 mm projectors.



SPEEDY (p.105)

Do not use with orange and white caps



FLIP (p.105)



MINI-JECT SYRINGES

Reusable 11 mm nylon syringes.

- Nylon syringe body, for use with blowpipes and/or projectors with 11 mm barrel.
- The injection pressure is produced by gas (visible).
- Stabilisers: made from wool or PVC **additional**.
- Cannulas **additional**.

Supplied by 5 with 1 gas remover and 1 plunger pusher (code 192280 p.104).



Code x 5	Model	Size	Capacity	Weight
192266	Mini-Ject syringe barrel	45 mm	1 mL	4.54 g
192268	Mini-Ject syringe barrel	55 mm	2 mL	4.44 g
192270	Mini-Ject syringe barrel	70 mm	3 mL	4.82 g
192272	Mini-Ject syringe barrel	115 mm	5 mL	6.09 g

[p.101 Find cannulas for 11 mm syringes](#)



WOOL STABILISER

Stabiliser compatible with short to medium distance shots.

- For use when shooting the two blowpipes, the Delta models and all gas projectors.
- Placed on the 11 mm Mini-Ject and Softy syringes.

Supplied by 5.

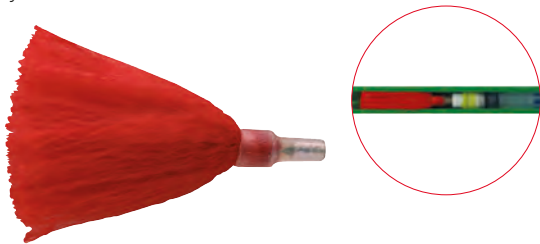

Code x 5	Model	Weight
192264	11 mm Wool stabiliser	0.75 g

SOFTY SYRINGES

Reusable 11 mm nylon syringes.

- Nylon syringe for use with blowpipes and all projectors with 11 mm barrel.
- The injection pressure is produced by gas (visible) or compressed air (not visible).
- Removable wool stabiliser included.
- Weight: 6.8 g.
- Graduations at 1, 2, 3 and 3.8 mL.
- Option: PVC stabiliser when shooting with the Distinject blowpipe (code 192036 p.89).
- Cannulas **additional**.

Supplied by 5 with 1 gas remover and 1 plunger pusher (192280 p.104). Practice cannulas (192185 p.101) are not supplied with syringes.



Code x 5	Model	Size	Capacity
192222	Softy syringe	115 mm	3.8 mL

[p.101 Find cannulas for 11 mm syringes](#)

[p.89 Find Distinject blowpipe](#)

PVC STABILISER

Stabiliser compatible with short distance shots.

- Only used when shooting the Distinject blowpipe (code 192036 p.89), with 11 mm Mini-Ject or Softy syringes.
- The ergonomics of the stabilizer limits the loss of air introduced by the shooter, and improves the range.
- 16 mm diameter.

Supplied by 5.

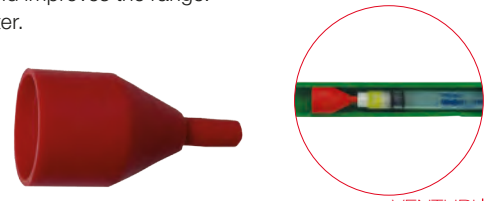

VENTURI EFFECT

Code x 5	Model	Weight
192274	16 mm PVC stabiliser	1.60 g

[p.89 Find Distinject blowpipe](#)

EASY SYRINGES

Reusable 11 mm nylon syringes for long distance use.

- Nylon syringes specially designed for long-distance shots, for use with all projectors with an 11 mm barrel.
- The injection pressure is produced by gas.
- Attached stabiliser (feathered) for more accurate long-distance shots.
- Weight: 6.6 and 7.9 g.
- Cannulas **additional**.

Supplied by 5 with 1 gas remover and 1 plunger pusher (192280 p.104). Practice cannulas (192185 p.101) are not supplied with syringes.



Code x 5	Model	Size	Capacity
192260	Easy syringe	125 mm	3 mL
192262	Easy syringe	170 mm	5 mL

[p.101 Find gas remover and cannulas for 11 mm syringes](#)



SMOOTH CANNULAS 1.1 MM & 1.3 MM DIAMETERS

Smooth cannulas, preferably used for vaccination of small animals.

For use on nylon syringes projected by the two blowpipes, Delta models and all gas projectors.

- The hole in the needle allows injection of the product when the plug is pushed back at the moment of impact.

Supplied by 5.



Code x 5	Model	Cannula length
192242	Smooth cannula, 1.1 mm diameter	25 mm
192240	Smooth cannula, 1.3 mm diameter	38 mm

[p.100 Find nylon syringes](#)

SMOOTH CANNULAS 1.6 MM & 2.1 MM DIAMETERS

Smooth cannulas, preferably used for vaccination of medium- and large animals.

For use on nylon syringes projected by the two blowpipes, Delta models and all gas projectors.

- The hole in the needle allows injection of the product when the plug is pushed back at the moment of impact.

Supplied by 5 (with 1 weight and 4 additional plugs per cannula).



Code x 5	Model	Cannula length
192257	Smooth cannula, 1.6 mm diameter + weight	20 mm
192256	Smooth cannula, 1.6 mm diameter + weight	25 mm
192254	Smooth cannula, 1.6 mm diameter + weight	38 mm
192258	Smooth cannula, 2.1 mm diameter + weight	51 mm

[p.100 Find nylon syringes](#)

CANNULAS WITH BARB 1.6 & 2.1 MM DIAMETERS

For use on nylon syringes projected by the two blowpipes, the Delta Special model and all gas projectors.

- The hole in the needle allows injection of the product when the plug is pushed back at the moment of impact.
- The barb keeps the syringe in place during injection of the product.

Supplied by 5 (with 1 weight and 4 additional plugs per cannula).



Code x 5	Model	Cannula length
192246	Cannula with barb, 1.6 mm diameter + weight	25 mm
192244	Cannula with barb, 1.6 mm diameter + weight	38 mm
192243	Cannula with barb, 2.1 mm diameter + weight	51 mm

[p.100 Find nylon syringes](#)

CANNULAS WITH FLANGE 1.6 & 2.1 MM DIAMETERS

For use on nylon syringes projected by the two blowpipes, the Delta Special model and all gas projectors.

- The hole in the needle allows injection of the product when the plug is pushed back at the moment of impact.
- The flange keeps the syringe in place during injection of the product and is less traumatic than the barb.

Supplied by 5 (with 1 weight and 4 additional plugs per cannula).



Code x 5	Model	Cannula length
192250	Cannula with flange, 1.6 mm diameter + weight	25 mm
192248	Cannula with flange, 1.6 mm diameter + weight	38 mm
192252	Cannula with flange, 2.1 mm diameter + weight	51 mm

[p.100 Find nylon syringes](#)

PRACTICE CANNULAS

For use with all 11 mm syringes (Mini-Ject, Softy, Easy).

Supplied by 5 with 1 weight per cannula.



Code x 5	Model
192185	Practice cannula + weight

[p.100 Find 11 mm syringes](#)

CANNULA PLUGS

Supplied in bags of 10.



Code x 10	Model
A 192338	Plug for cannula 1.1 mm and 1.2 mm diameter
B 192340	Plug for cannula 1.6 mm and 2.1 mm diameter

WEIGHT FOR CANNULAS

Placed on the end of nylon syringes (Mini-Ject, Softy and Easy) after loading the needle for increasing the range above 6 m.



Code	Model
192276	Cannula weight



ALUMINUM SYRINGES

Reusable anodised aluminum syringes for 13 mm projectors. Can be fully disassembled.

- Advantages: more stable (weather) and shock resistant.
- Suitable for using cannula on animals with thick skin.
- Large choice of capacities (1 to 15 ml).
- The complete syringes are supplied disassembled, to permit greasing the syringe barrel and plunger before use.
- A syringe comprises:
 - an anodised aluminum syringe barrel,
 - a rubber plunger,
 - a stabiliser.
- Must be supplemented with an appropriate injection capsule, a cannula (p.103), a PVC rod (192328 p.104) and silicone grease (192320 p.104) for maintenance.



Code	Model	Size	Capacity
192200	Complete aluminum syringe	110 mm	1 mL
192202	Complete aluminum syringe	120 mm	2 mL
192204	Complete aluminum syringe	130 mm	3 mL
192206	Complete aluminum syringe	140 mm	4 mL
192208	Complete aluminum syringe	155 mm	5 mL
192210	Complete aluminum syringe	175 mm	7 mL
192212	Complete aluminum syringe	205 mm	10 mL
192214	Complete aluminum syringe	255 mm	15 mL

ANODISED ALUMINUM SYRINGE BARRELS

High-quality anodised aluminum syringe barrels for 13 mm diameter projectors, enabling powerful high-performance shooting.

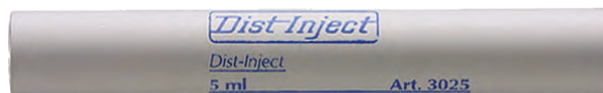

Code	Model	Size	Capacity
192100	Syringe barrel	55 mm	1 mL
192102	Syringe barrel	65 mm	2 mL
192104	Syringe barrel	75 mm	3 mL
192106	Syringe barrel	85 mm	4 mL
192108	Syringe barrel	100 mm	5 mL
192110	Syringe barrel	120 mm	7 mL
192112	Syringe barrel	150 mm	10 mL
192114	Syringe barrel	200 mm	15 mL

FEATHERED STABILISER

Goose feather stabiliser compatible with 13 mm anodised aluminum syringes.

- Stabilises the syringe, allowing accurate shooting at long range.



Code	Model	Length
192182	Feathered stabiliser	55 mm

WOOL STABILISER

Wool stabiliser compatible with 13 mm anodised aluminum syringes.

- Stabilises the syringe, allowing accurate shooting at short to medium range.
- For an use with gaz projectors only.

DO NOT USE WITH POWDER PROJECTORS.



Code	Model
192192	Wool stabiliser

YELLOW PLASTIC STABILISER

Yellow plastic stabiliser with metal mouthpiece compatible with 13 mm anodised aluminum syringes. Stabilises the syringe, allowing accurate shooting at long range.

- Do not use with orange and white percussion caps.



Code	Model
192194	Yellow plastic stabiliser

PLUNGER

Rubber plunger.

- Grease the piston with silicone grease (p.104) and place the injection capsule inside before inserting it into the aluminum barrel.

Supplied by unit.



Code	Model
192180	Rubber plunger

INJECTION CAPSULES

Capsules with firing pin triggering product injection upon impact. Positioned in the plunger, placed in the anodised aluminum syringe barrel.

Supplied by 10.

DO NOT PRESS THE FIRING PIN.

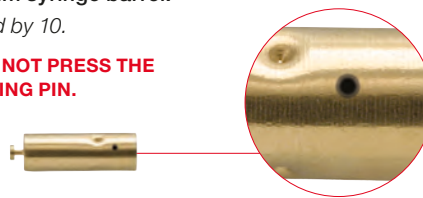

VISUAL CODE



Code x 10	Model	Visual code
192290	Injection capsule 1 to 5 mL	•
192292	Injection capsule 7 to 10 mL	••
192294	Injection capsule 15 mL	•••



SMOOTH CANNULAS 2.5 MM DIAMETER

Cannulas compatible with 13 mm anodised aluminum syringes, smooth.

- Holes allow product injection upon impact.
- Aluminum hubs and stainless steel cannulas.

Supplied individually.



Code	Distinct reference	Length	Number of holes
192120	NA2	19 mm	1 hole
192122	NA3	28 mm	2 holes
192124	NA4	32 mm	2 holes

CANNULAS WITH FLANGE 2.5 MM DIAMETER

Cannulas compatible with 13 mm anodised aluminum syringes.

- Holes allow product injection upon impact.
- Aluminum hubs and stainless steel cannulas.
- The flange keeps the syringe in place for injection of the product and is less traumatic than the barb.

Supplied individually.



Code	Distinct reference	Length	Number of holes
192144	NS1	16 mm	1 hole
192146	NS2	19 mm	1 hole
192132	NM1	28 mm	1 hole
192134	NM2	32 mm	2 holes
192136	NM3	41 mm	2 holes
192138	NM4	45 mm	2 holes
192140	NM5	51 mm	2 holes
192142	NM6	63 mm	2 holes

AFRICAN CANNULAS 4 MM DIAMETER

Reinforced smooth cannulas compatible with 13 mm anodised aluminum syringes.

- Holes allow product injection upon impact.
- Large diameter cannulas, specially adapted for use on large animals.
- Stainless steel hubs and cannulas.

Supplied individually.

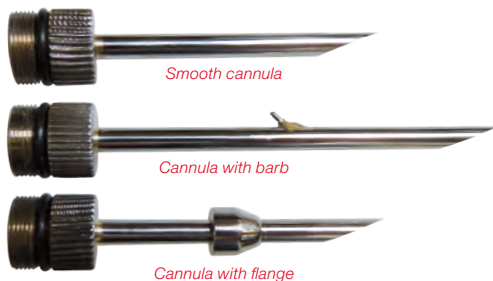

Code	Distinct reference	Type of cannula	Length
192148	EN1	Smooth	48 mm
192150	EN2	Smooth	68 mm
192152	EN3	Smooth	78 mm
192154	EH1	Barb	48 mm
192156	EH2	Barb	68 mm
192158	EH3	Barb	78 mm
192160	EC1	Flange	48 mm
192162	EC2	Flange	68 mm
192164	EC3	Flange	78 mm

CANNULAS WITH BARB 2.5 MM DIAMETER

Cannulas compatible with 13 mm anodised aluminum syringes.

- Holes allow product injection upon impact.
- Aluminum hubs and stainless steel cannulas.
- The barb keeps the syringe in place for injection of the product.

Supplied individually.



Code	Distinct reference	Length	Number of holes
192126	NC1	19 mm	1 hole
192128	NC2	28 mm	2 holes
192130	NC3	41 mm	2 holes

CANNULAS WITH BRAKE 2.5 MM DIAMETER

Cannulas compatible with 13 mm anodised aluminum syringes, with brake enabling a less traumatic shot.

- Cannulas with barb.
- Aluminum hubs and stainless steel cannulas.

Supplied individually.



Code	Length
192186	19 mm
192188	28 mm
192189	38 mm

ACCESSORIES

Code x 4	Model
192190	Replacement brake blades (19 mm x 2/28 mm)

ELEPHANT CANNULAS 4 MM DIAMETER

Smooth cannulas compatible with 13 mm anodised aluminum syringes.

- Holes allow product injection upon impact.
- Aluminum hubs and stainless steel cannulas.

Supplied individually.

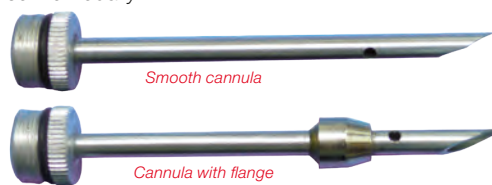

Code	Model	Length	Number of holes
192166	Smooth elephant cannula	65 mm	2 holes
192168	Elephant cannula with flange	65 mm	2 holes

PRACTICE CANNULAS 2.5 MM DIAMETER

Practice cannula for 13 mm anodised aluminum syringes.

- Aluminum hubs and stainless steel cannulas.

Supplied by 5.



Code x 5	Model
192184	Practice cannula for 13 mm anodised aluminum syringes



■ PLUNGER PUSHER

Plunger pusher for 11 mm syringes.

- Replaces the Mini-ject syringe pusher.
- Can be used with Softy syringes.



Code	Model
192337	Plunger pusher

[p.100 Find 11 mm syringes](#)

■ GAS REMOVER AND PLUNGER PUSHER

Gas remover and plunger pusher for use with reusable 11 mm syringes (Mini-Ject, Softy, Easy).

- The plunger pusher is used with a standard 10 mL Luer syringe.

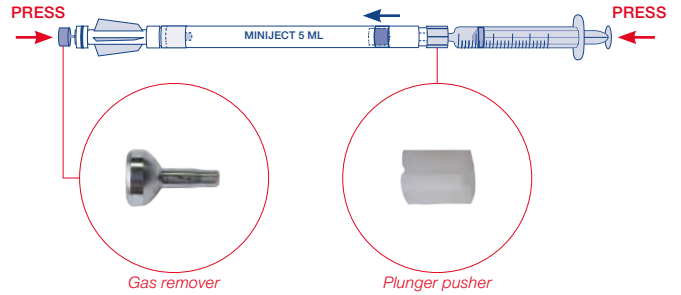

Code	Model
192280	Gas remover and plunger pusher

[p.100 Find 11 mm syringes](#)

■ 65 ML GAS REFILL

Gas refill for 11 mm syringes and 45 Delta model.



Code	Model
192342	Gas refill 65 mL

■ SILIGLISS

Thick silicone oil for lubricating seals on all projectors.

Supplied by unit.



Code	Model
106020	10 mL tube

■ PVC ROD

Multi-use 20 cm PVC rod for aluminium syringes.

- Used to grease anodised aluminum barrels with silicone grease.
- Lets you put the injection capsule and plunger set in an aluminium syringe.



POSITIONING
MARKER

Code	Model
192328	PVC plunger lubricating rod

[p.102 Find aluminum syringes](#)

■ SILICONE GREASE

12 g tube for lubricating rubber plungers and 13 mm aluminum syringes barrels before each use.



Code	Model
192320	Silicone grease 12 g

[p.102 Find aluminum syringes](#)



■ SPEEDY SYRINGES

Disposable automatic syringes, for use with all 13 mm projectors.

- Lightweight (between 13 and 14 g), limits the risk of injury.
- Easy preparation: requires only introduction of the anaesthetic product via the cannula.
- Cannula with barb.
- Built-in percussion cap triggers product injection upon impact.
- Safety pin.
- Disposable for hygiene and performance.
- Contents: **3 mL**.
- Range 5 to 40 m.
- Do not use with orange and white percussion caps.

Supplied by 4 with filling cannula.



■ FLIP SYRINGES

Automatic disposable syringe, for use with all 13 mm projectors, particularly compatible with remote anaesthesia of small monkeys.

- Lightweight (5 g), limits the risk of injury.
- Easy preparation: requires only introduction of the anaesthetic product via the cannula.
- Smooth cannula.
- Built-in percussion cap triggers product injection upon impact.
- Disposable for hygiene and performance.
- Contents: **1 mL**.
- Range 30 to 60 m.

Supplied by 4 with filling cannula.



Code x 4	Model	Cannula diameter	Cannula length
192216	Speedy syringe 3 mL	2 mm	20 mm
192218	Speedy syringe 3 mL	2 mm	30 mm

Code x 4	Model	Cannula diameter	Cannula length
192220	Flip syringe	2.5 mm	13 mm

[p.97 Find our percussion cap selection guide](#)

READY TO USE

for all 13 mm projectors, with gas or powder

1) LOAD THE LIQUID FROM THE SYRINGE.

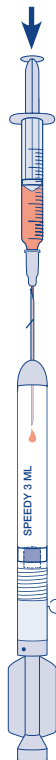

2) REMOVE THE SAFETY PIN.

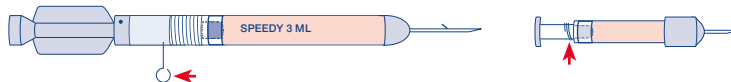

3) LOAD THE PROJECTOR AND SHOOT.



■ AUTOMATIC INJECTION STICK

Pole syringes for instantaneous injection.

Maximum capacity 5 mL. Length 35 cm.

- Full equipment:
 - 1 syringe of 5 mL,
 - 2 bags of 5 disposable needles diameter 1.6 x 19 mm (dogs/cats)
or 2 bags of 5 disposable needles diameter 2.0 x 25 mm (cattle/horses).
 - 65 mL gas refill,
 - 1 plunger pusher (code 192337 p.104).
- Option: 85 cm extension.



Code	Model	Needle size	Use	Pack.
192372	Automatic injection stick - full equipment	diameter 1.6 x L 19 mm	Dogs/cats	2 bags of 5 needles
192370	Automatic injection stick - full equipment	diameter 2.0 x L 25 mm	Cattle/horses	2 bags of 5 needles
192376	16G x 3/4" needles	diameter 1.6 x L 19 mm	Dogs/cats	1 bag of 5 needles
192378	14G x 1" needles	diameter 2.0 x L 25 mm	Cattle/horses	1 bag of 5 needles
A 192380	5 mL syringe only	-	-	-

ACCESSORIES

Code	Model
192342	Gas refill 65 mL only (p.104)

■ EXTENSION FOR AUTOMATIC INJECTION STICK

Rigid extension which is screwed to the tip of the automatic injection stick above.



Maximum extension = 205 cm
35 cm automatic injection stick + 85 cm extension + 85 cm extension

Code	Model
192374	Extension for 85 cm automatic injection stick

p.9-10 [Find extended hypodermic syringes](#)

p.17 [Find injection extension stick](#)

DISTINJECT POLE

Professional quality, quick-release aluminum capture pole.

- Ideal for intensive use or for very large dogs.
- Lightweight and durable.
- 2 non-slip grip handles. **A**
- 22 mm diameter reinforced aluminum tube.
- 3 mm multi-core stainless steel cable, plastic coated, withstands a load of up to 450 kg.
- Two cable release systems:
 - ball handle for lock and instantaneous cable release system. **B**
 - instantaneous release ring. **C**
- Fixed head for hanging the cable. **D**

On request: 30 cm rubber protection sheath under the head (protection from dogs' teeth).

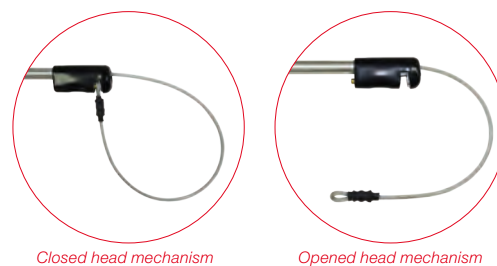

Closed head mechanism

Opened head mechanism



PROFESSIONAL
QUALITY

Code	Model	Weight	Length
192400	Capture pole quick lock and release	1.06 kg	70 cm
192402	Capture pole quick lock and release	1.22 kg	100 cm
192404	Capture pole quick lock and release	1.34 kg	120 cm
192406	Capture pole quick lock and release	1.57 kg	150 cm
192408	Capture pole quick lock and release	2.00 kg	200 cm

REINFORCED POLE

Professional quality, reinforced pole for capturing dogs of all sizes.

- 2 grip handles. **A**
- 32 mm diameter reinforced aluminum tube.
- Coated galvanised steel cable with a diameter of 3 mm, withstands a load of up to 450 kg.
- Adjustable handle for easy handling of the pole. **E**
- Two cable release systems:
 - ball handle for lock and instantaneous cable release system. **B**
 - instantaneous release ring. **C**

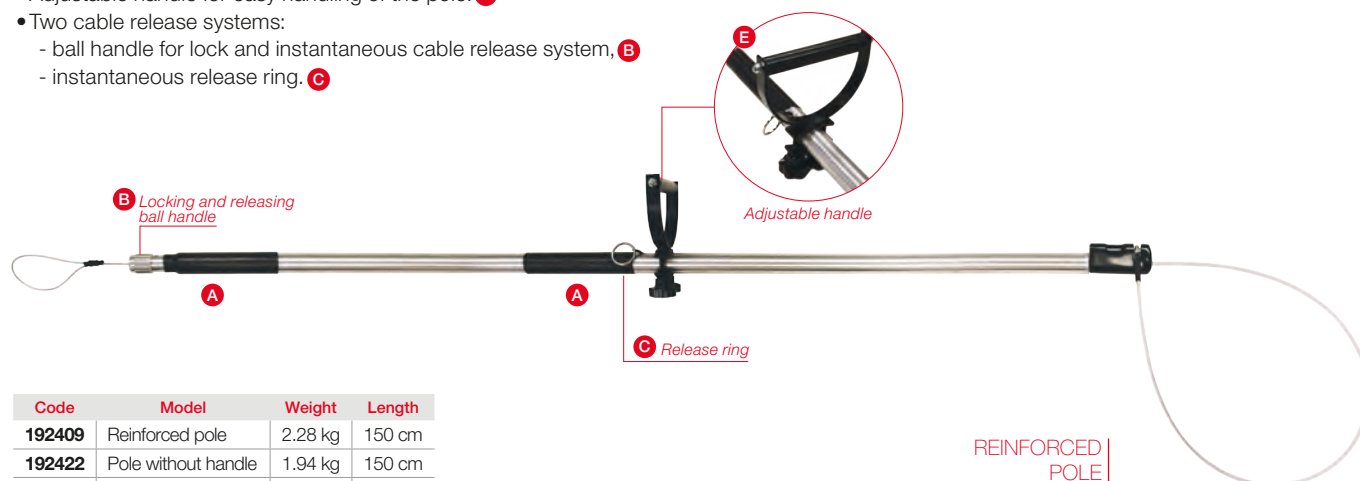

REINFORCED
POLE

Code	Model	Weight	Length
192409	Reinforced pole	2.28 kg	150 cm
192422	Pole without handle	1.94 kg	150 cm
192421	Pole without handle	1.36 kg	110 cm
192424	Sliding handle only	-	-



■ ROTATABLE HEAD POLE

Pole with a rotatable head, professional quality, for capturing dogs of all sizes.

- 2 non-slip grip handles. **A**
- 22 mm diameter reinforced aluminum tube with protective sheath. **C**
- 3 mm multi-core stainless steel cable, plastic coated, withstands a load of up to 450 kg.
- Ball handle for lock and instantaneous cable release system. **B**
- Anti-strangulation rotatable head. **D**



PROFESSIONAL
QUALITY

Code	Model	Weight	Size
221430	Rotatable head pole, reinforced tube	0.96 kg	120 cm
221432	Rotatable head pole, reinforced tube	1.25 kg	150 cm

■ TELESCOPIC POLE

Professional quality telescopic pole with rotatable head for capturing dogs of all sizes.

- Identical to rotatable head pole, with an extension capacity from 120 to 180 cm.
- Locking ring. **E**

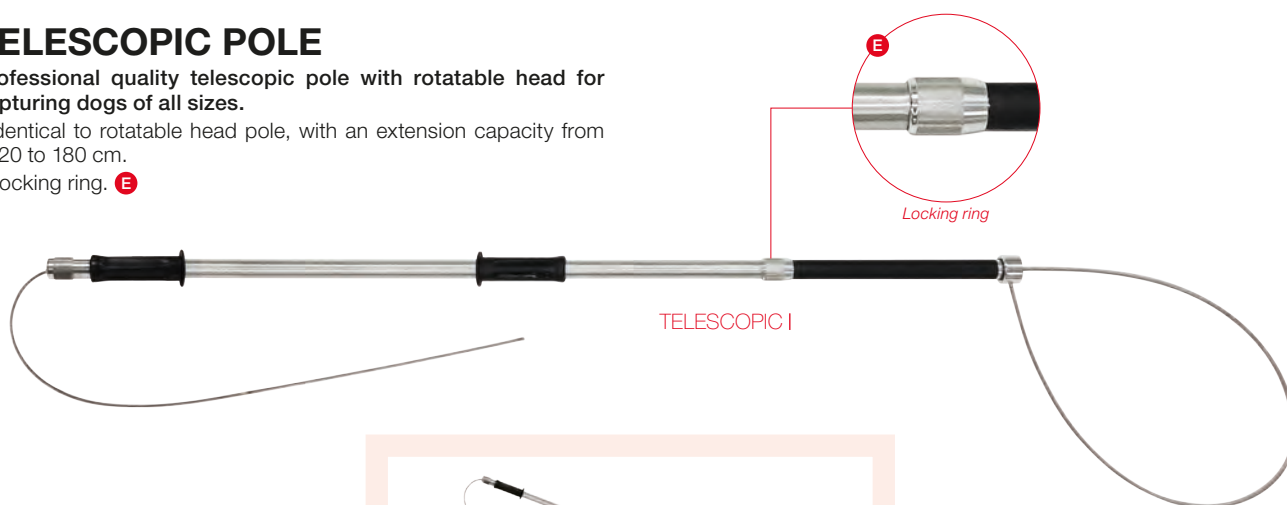

PROFESSIONAL
QUALITY

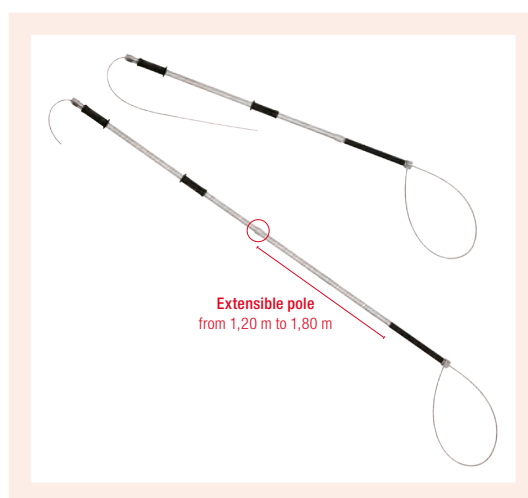

Code	Model	Weight	Size
221434	Telescopic pole	1.16 kg	120-180 cm

■ LASCAP ALU BASIC

Restraint pole with simple slipknot, without locking handle, for dogs.

- Anodised aluminum tube.
- Plastic handles.
- Sheathed stainless steel cable.
- Fixed anchorage.

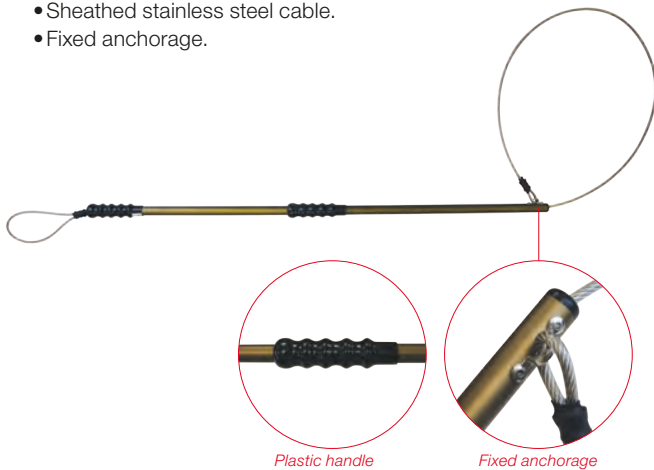

Plastic handle

Fixed anchorage

Code	Weight	Length
221350	800 g	100 cm
221351	985 g	150 cm

■ LASCAP ALU SUPERIOR

Restraint pole featuring a slipknot with immediate neck release ring and snap hook, without locking handle, for dogs.

- Identical to Lascap Alu Basic.
- Ring and snap hook for immediate release.

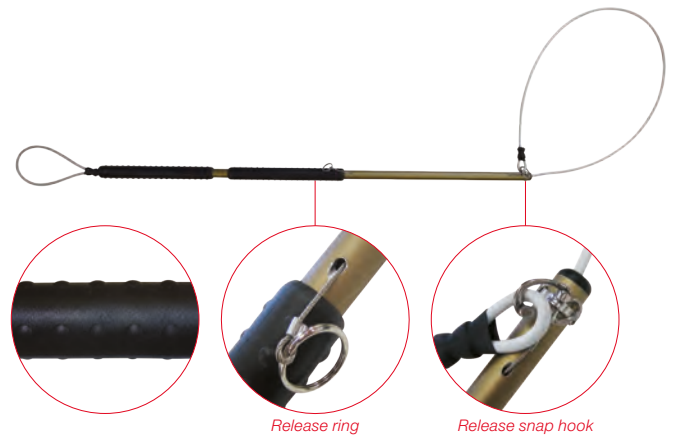

Release ring

Release snap hook

Code	Weight	Length
221352	815 g	100 cm

■ LASCAP ALU PLUS

Restraint pole with simple slipknot without immediate neck release, featuring anti-strangulation lock-handle, for dogs.

- Identical to Lascap Alu Basic.
- Instant locking handle.
- Fixed anchorage.

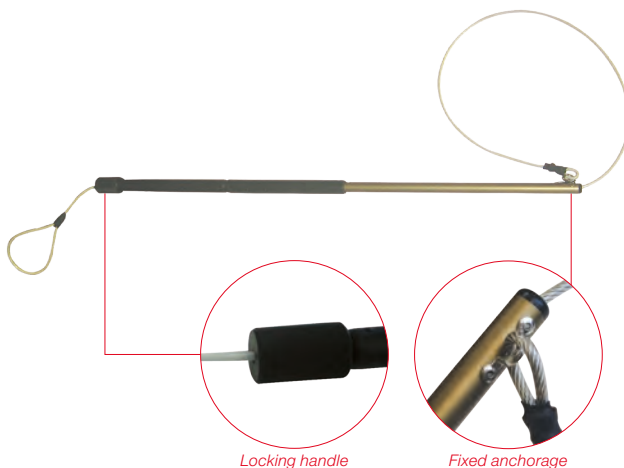

Locking handle

Fixed anchorage

Code	Weight	Length
221356	1.5 kg	100 cm
221357	1.1 kg	150 cm

■ LASCAP ALU PROFESSIONAL

Restraint pole featuring a slipknot with immediate neck release ring and featuring anti-strangulation lock-handle, for dogs.

- Identical to Lascap Alu Basic.
- Ring and snap hook for immediate release.
- Instant locking handle.

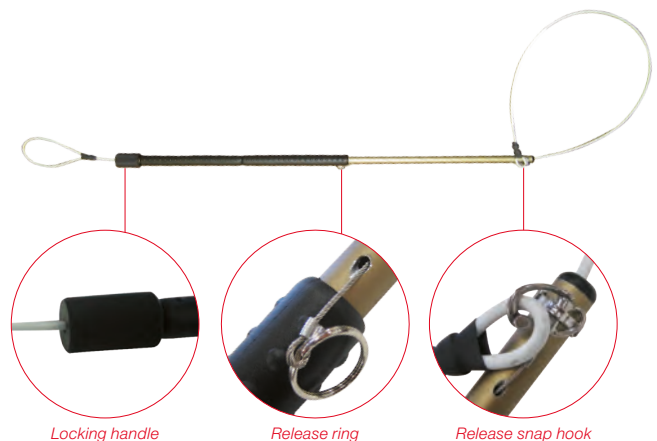

Locking handle

Release ring

Release snap hook

Code	Weight	Length
221354	870 g	100 cm
221355	1.1 kg	150 cm



■ SINGLE DOOR CAT TRAP

Metal cat trap with single door.

- Door closes under the pressure of the animal's weight on the tray.
- Steel trap door. **A**
- Swinging plate. **B**
- Removable sliding door to position the trap and retrieve the animal. **C**
- Fully mechanised system.
- Strong and lightweight.
- Carrying handle.
- Mesh: 2.5 x 2.5 cm.
- **2.5 mm** diameter steel wire coated with lacquer paint.
- Effective dimensions for the animal: 53 x 25 x 25 cm.

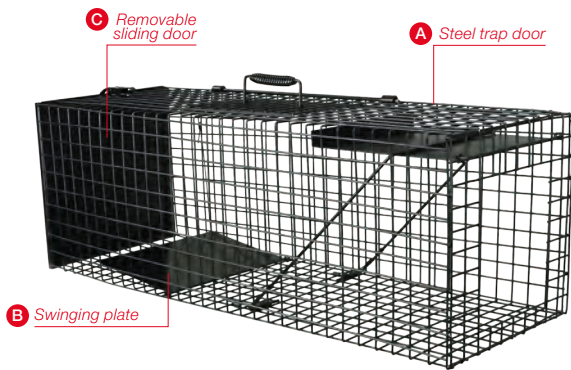

Code	Model	Weight	Dimensions
192550	Single door cat trap	3.8 kg	77 x 25 x 25 cm

■ DOUBLE DOOR CAT TRAP

Metal cat trap with double door.

- Doors closes under the pressure of the animal's weight on the tray.
- Trap doors in lacquered painted steel.
- Swinging plate.
- Fully mechanised system.
- Very strong.
- The double door system allows the cat to see a potential exit, thereby encouraging it to enter the trap.
- Carrying handle.
- Mesh: 2.5 x 2.5 cm.
- **2.5 mm** diameter steel wire coated with lacquer paint.
- Effective dimensions for the animal: 104 x 36 x 32 cm.

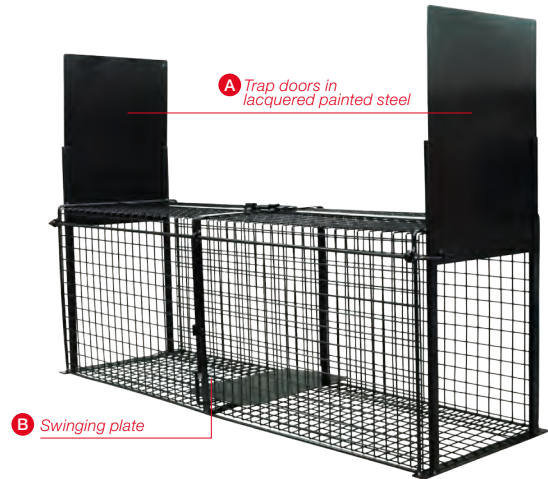

Code	Model	Weight	Dimensions
192552	Double door cat trap	9.3 kg	108 x 50 x 34 cm

■ REINFORCED CAT TRAP

Reinforced metal cat trap with single entrance.

- Door closes under the pressure of the animal's weight on the tray.
- Plexiglas guillotine door. **A**
- Fully mechanised system.
- Very robust, **particularly resistant outdoors** (humid or salty environment).
- Carrying handle.
- Sheet metal back with epoxy paint coating.
- Mesh: 2.5 x 7.5 cm.
- **2.3 mm** diameter steel wire coated with epoxy paint.
- Trap mechanism rod made of stainless steel.

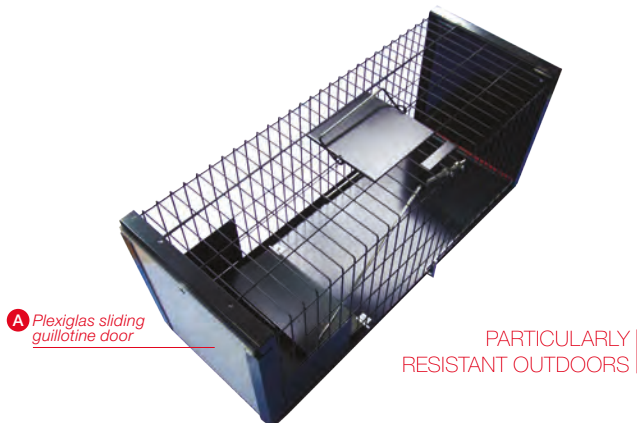

Code	Model	Weight	Dimensions
192554	Reinforced metal trap	7.3 kg	76 x 28 x 32 cm

■ FOLDING CAT TRAP

Folding stainless steel cat trap with single entrance.

- Door closes under the pressure of the animal's weight on the tray.
- Galvanised steel trap door. **A**
- Plexiglas sliding access door to place the bait on the tray or to extract the trapped animal. **B**
- Fully mechanised system.
- Strong.
- Carrying handle.
- Mesh: 2.5 x 5 cm.
- Aluminum trap bottom.
- 2 mm diameter steel wire with epoxy paint coating.
- Trap mechanism cable with protective sheath.



Code	Model	Weight	Dimensions
192556	Folding cat trap	5.5 kg	77 x 28 x 33 cm (8 cm folded)

For bird traps and kennels, request our *Distinfect Capture* brochure or download it on our website.



■ FOLDING DOG TRAP

Reinforced folding metal dog trap, with single door.

- Door closes under the pressure of the animal's weight on the tray.
- Painted steel trap door with locking rings. **A**
- Painted steel guillotine door. **B**
- Slot for inserting a pole to capture the animal. **C**
- Fully mechanised system.
- Strong.
- Carrying handle.
- Painted steel trap mesh.
- Trap mechanism rod made of painted steel.
- Painted steel trap door frame.
- Mesh: 5 x 5 cm.
- 2.3 mm diameter wire.
- Effective dimensions for the animal: 124 x 49 x 60 cm.

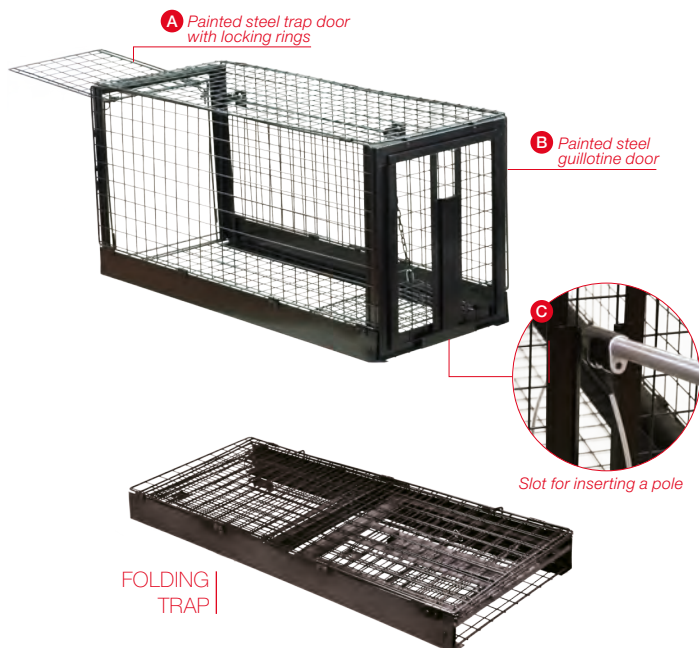

Code	Model	Weight	Dimensions
192560	Folding dog trap	20.3 kg	128 x 52 x 61 cm (12 cm folded)

■ REINFORCED COLLAPSIBLE DOG TRAP

Reinforced collapsible dog trap, with single door.

- Door closes under the pressure of the animal's weight on the tray.
- Accordion door.
- Fully mechanised system.
- Ultra-resistant reinforced structure suitable for capturing aggressive animals.
- Panel designed to place a bait on.
- Trap mechanism cable made of galvanized steel.
- Full epoxy paint coating.
- Mesh: 5 x 5 cm.
- 4 mm diameter wire.
- Effective dimensions for the animal: 110 x 65 x 65 cm.



Code	Model	Weight	Dimensions
192558	Reinforced collapsible dog trap	34.0 kg	128 x 65 x 65 cm

For bird traps and kennels, request our *Distinfect Capture* brochure or download it on our website.



HOLDING KENNEL WITH ONE DOOR

Holding kennel for cats in plastic coated steel wire, with top door.

- Holding grid, which is easily manoeuvrable from the outside.
- Top door for putting the animal in.
- Strong.
- Mesh: 2.5 x 2.5 cm, narrower near the handle to protect the handler.
- 3 mm diameter coating steel wire.

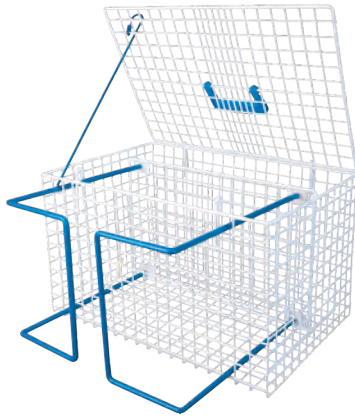

Code	Model	Weight	Dimensions
192610	Holding kennel with one door	2.9 kg	44 x 30 x 29 cm

HOLDING KENNEL WITH TWO DOORS

Holding kennel for cats in painted steel wire, with top door and side door.

- Holding grid, which is easily manoeuvrable from the outside. **A**
- Two doors: one top door for putting the animal in and a side door for removing the animal.
- Strong.
- Mesh: 2.5 x 2.5 cm, narrower near the handle to protect the handler.
- 2.5 mm diameter painted steel wire.

The restraining plate cannot be sold separately.

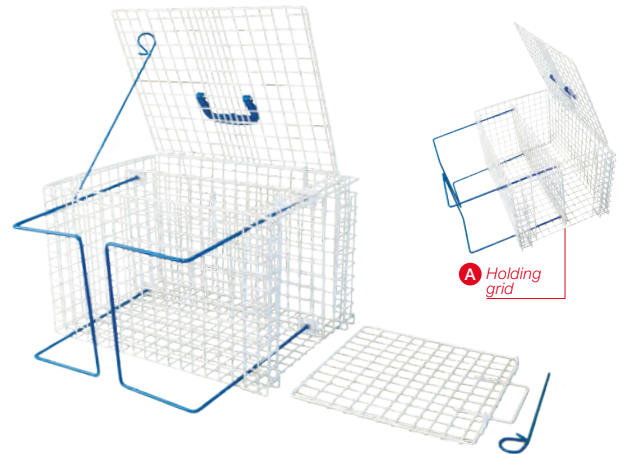

Code	Model	Weight	Dimensions
192612	Holding kennel with two doors	3.8 kg	45 x 30 x 30 cm

REINFORCED TRANSPORT KENNEL

Galvanised steel reinforced transport kennel for transporting small animals.

- Perforated sheet metal that prevents scratches and bites through the kennel. **A**
- Reliable and quick-release butterfly catch closure. **B**
- Guillotine door. **C**
- Rubber-lined door to decrease noise caused by vibrations, and to prevent injuries.
- Rubber anti-slip pads.
- Carrying handle.

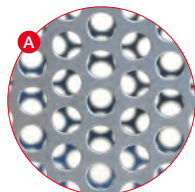

Perforated sheet metal Prevents scratches and bites

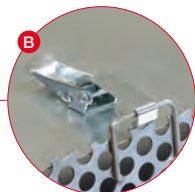

Butterfly catch closure



Rubber-lined guillotine door



Code	Model	Weight	Dimensions
192616	Reinforced transport kennel	3.9 kg	45 x 30 x 30 cm

STRAY KENNEL

Galvanised steel two-door stray kennel with side shields.

- Very sturdy, welded mesh.
- Can be locked using padlocks or another closure system.
- Guillotine doors.
- PVC side protection on both sides.
- 4 side handles for easy handling.
- Bottom of the kennel has a removable anti-slip rubber mat.
- Mesh: 5 x 5 cm.
- 4 mm diameter galvanised steel wire.



Code	Model	Weight	Dimensions
192614	Stray kennel	33.5 kg	103 x 64 x 71 cm

For bird traps and kennels, request our Distinct Capture brochure or download it on our website.

■ FOLDING METAL KENNELS

Galvanised steel folding metal kennel.

- Removable tray.
- Sliding handle lock.
- 2 doors for easy access: side and front.
- Carrying handle.
- Quick and easy setup.
- Mesh: 13 x 3 cm.
- 3 mm diameter galvanised steel wire.

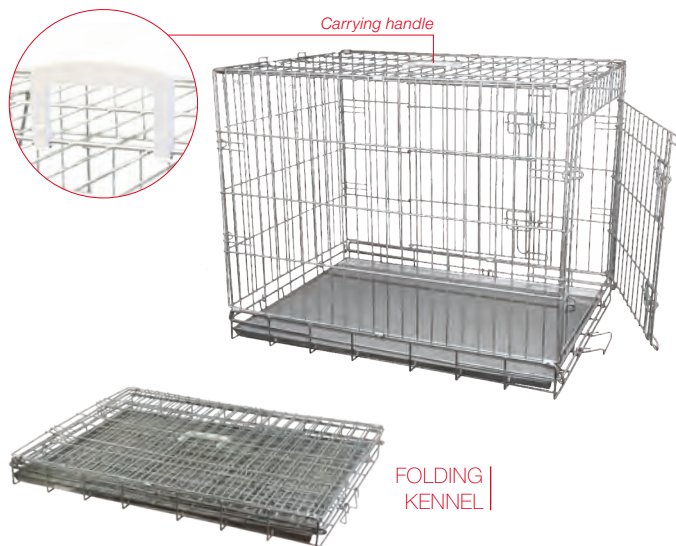

Code	Model	Weight	Dimensions
192622	Folding metal kennel	8 kg	55 x 63 x 61 cm (7 cm folded)
192624	Folding metal kennel	11.0 kg	54 x 76 x 61 cm (7 cm folded)
192626	Folding metal kennel	13.5 kg	58 x 88 x 67 cm (7 cm folded)
192628	Folding metal kennel	19.0 kg	68 x 107 x 75 cm (7 cm folded)
192630	Folding metal kennel	20.2 kg	76 x 122 x 84 cm (7 cm folded)

■ WAKEFIELD FOLDING METAL KENNELS

Wakefield folding galvanised steel kennel with plastic tray.

- Removable plastic tray.
- Sliding handle lock.
- Single door.
- Quick and easy setup.
- Mesh: 8.5 x 3 cm.
- 3 mm diameter galvanised steel wire.

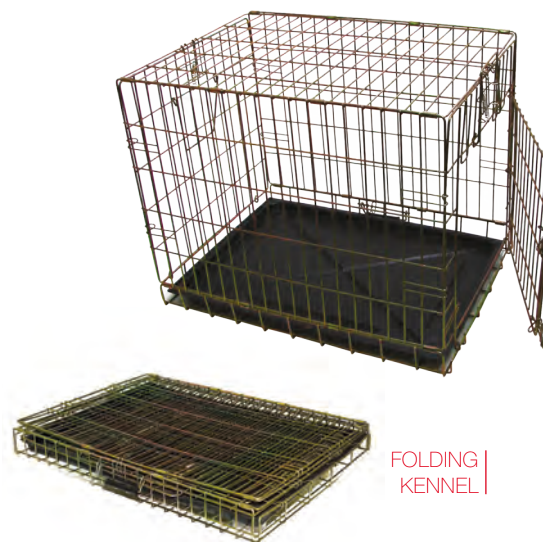

Code	Model	Weight	Dimensions
192656	Wakefield folding metal kennel	6.2 kg	62 x 46 x 50 cm (7 cm folded)

For bird traps and kennels, request our Distinct Capture brochure or download it on our website.

For bird traps and kennels, request our Distinct Capture brochure or download it on our website.

STANDARD VARI-KENNEL

Lightweight transport case that is very strong and particularly suited to transporting dogs, cats and other animals.

- Two superimposed parts with screw assembly.
- Welded mesh door.
- Carrying handle on the medium-sized kennel.
- Made of durable resin.
- Shockproof: withstands large stresses and strains.
- Very well ventilated.
- Beige colour.



Code	Model	Weight	Dimensions
192642	Standard Vari-Kennel: medium	5.1 kg	71 x 52 x 55 cm
192644	Standard Vari-Kennel: intermediate	5.7 kg	81 x 57 x 61 cm
192646	Standard Vari-Kennel: large	8.9 kg	91 x 64 x 69 cm
192648	Standard Vari-Kennel: extra large	9.2 kg	102 x 69 x 76 cm

VARI-KENNEL SKY KENNEL

Lightweight transport case that is very strong and particularly suited to transporting dogs, cats and other animals.

- Two superimposed parts with screw assembly.
- Reinforced 2 or 4 point lock.
- Welded mesh door and ventilation grills.
- Made of durable resin.
- Shockproof: withstands large stresses and strains.
- Very well ventilated.
- Grey colour.
- Complies with IATA standards for air transport (Air France).



Code	Model	Weight	Dimensions
192640	Sky Kennel Vari Kennel - 2 point lock	3.5 kg	53 x 41 x 38 cm
192650	Sky Kennel Vari Kennel - 4 point lock	20 kg	122 x 82 x 89 cm

STRETCHERS FOR TRANSPORTING ANIMALS

Rigid stretcher to transport injured or anaesthetised animals.

- 25 mm diameter aluminum tube frame.
- Wheels. **A**
- Carrying handles. **B**
- Securing straps.
- Durable washable vinyl canvas.



Code	Model	Weight	Dimensions
192620	Stretcher for transporting animals	4.1 kg	122 x 54 cm

For bird traps and kennels, request our *Distinject Capture* brochure or download it on our website.

■ REINFORCED CAPTURE TONGS FOR CATS

Reinforced capture tongs for feral and/or very aggressive cats.

- Moulded and polished aluminum handle and tongs.
- 2 mm diameter stainless steel cable allows gradual, controlled closure.
- 20 mm diameter **anodised aluminum** tube.
- Very robust, the cable is inside the tube to protect it from wear, and is soldered behind the handle.
- Lightweight.
- Ergonomic handle.

2 YEARS WARRANTY

Warranty is subject to proper use of the equipment. No damage should suggest an improper use of the material.

The warranty will only be applied upon receipt of the equipment and analysis of any malfunctions or damage found.

Subject to presentation of the receipt of purchase.

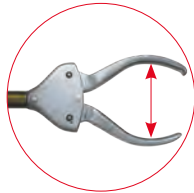

Opened tong = 90 mm

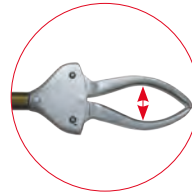

Closed tong = 40 mm

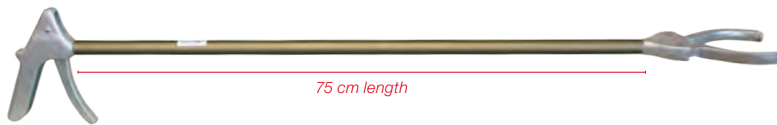

75 cm length



Extra long
150 cm length

ROBUST
2 MM

PROFESSIONAL
QUALITY

Code	Model	Weight	Length
192440	Reinforced capture tongs for cats	708 g	105 cm
192443	Reinforced capture tongs for cats	900 g	180 cm



■ CAPTURE LANDING NET

Capture landing net for small animals (reptiles).

- Rubber retention handle. **A**
- Open/close with a 6 mm coated cable. **B**
- 20 mm diameter anodised aluminum tube.
- Polyamid net.
- Fine 3.5 mm mesh to reduce risk of injury.
- The net can wrap around the handle to prevent escape.
- Strong.

FINE AND STRONG



Code	Model	Weight	Length	Net dimensions
192472	Capture landing net	920 g	140 cm	19 x 40 x 50 cm

■ ADJUSTABLE CAPTURE LANDING NET

Adjustable stainless steel landing nets for catching small animals (cats, birds, etc.).

- 2 rubber grip handles. **A**
- Open/close by sliding.
- Fine mesh to reduce risk of injury.
- Strong nylon net.
- 20 mm diameter stainless steel tube.



Code	Model	Weight	Length	Net dimensions (W x L x D)
192480	Adjustable capture landing net	2.2 kg	150 cm	42 x 76 x 71 cm

SPARE PARTS

Code	Model
192504	Replacement cable for landing net
192506	Replacement net for landing net

For bird traps and kennels, request our *Distinfect Capture* brochure or download it on our website.



■ REINFORCED CAPTURE TONGS FOR REPTILES

Reinforced tongs for catching large reptiles.

- Moulded and polished aluminum handle and tongs.
- 2 mm diameter stainless steel cable allows gradual, controlled closure.
- 20 mm diameter anodised aluminum tube.
- Very robust, the cable is inside the tube to protect it from wear, and is soldered behind the handle.
- Lightweight.
- Ergonomic handle.
- Grabber tongs for a better grip.

On demand: rubber jaw sheathing.

2 YEARS WARRANTY

Rubber jaw not warrantied.

Warranty is subject to proper use of the equipment. No damage should suggest an improper use of the material.

The warranty will only be applied upon receipt of the equipment and analysis of any malfunctions or damage found.

Subject to presentation of the receipt of purchase.

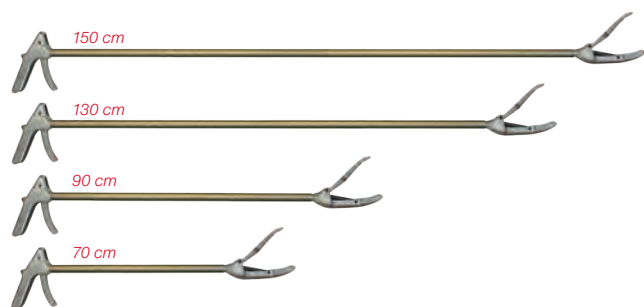
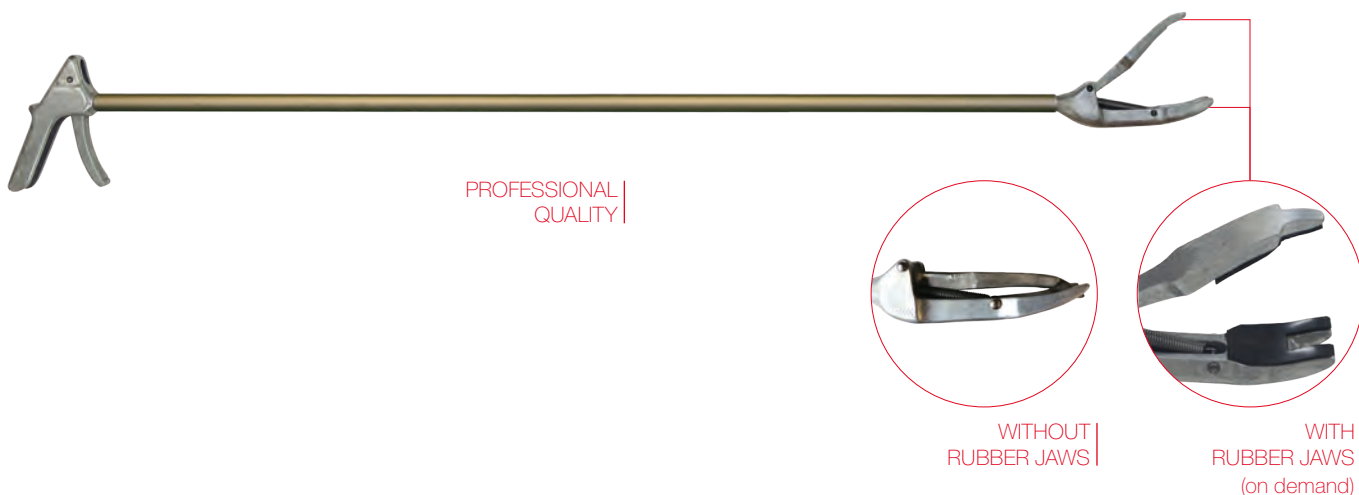

Code	Model	Weigth	Length
192445	Reinforced capture tongs for reptiles	855 g	150 cm
192444	Reinforced capture tongs for reptiles	820 g	130 cm
192447	Reinforced capture tongs for reptiles	720 g	90 cm
192448	Reinforced capture tongs for reptiles	685 g	70 cm

SPARE PARTS

Code	Model
192441	Jaws with additional rubber, including fitting

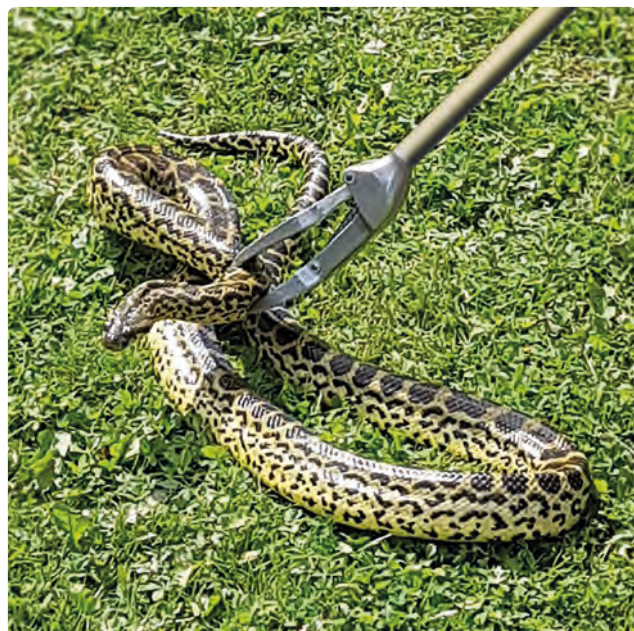

For reptiles equipment, request our *Distinfect Capture* brochure or download it on our website.

■ RESTRAINING POLE FOR REPTILES

Restraining pole for reptiles, suitable for use on all surfaces.

- End loop, metallic with soft leather strap, compatible with hard surface. **A**
- V-shaped metallic end, compatible with soft surface. **B**
- 20 mm diameter anodised aluminum tube.



Hard surface

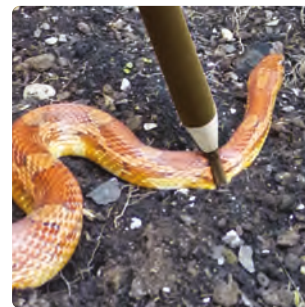

Soft surface



Code	Model	Weight	Length
192462	Restraining pole for reptiles	435 g	115 cm

■ HOOK FOR REPTILES

Hook for catching reptiles.

- Ergonomic rubber handle.
- Strong.
- Lightweight.
- 20 mm diameter anodised aluminum tube.
- Tapered hook end.

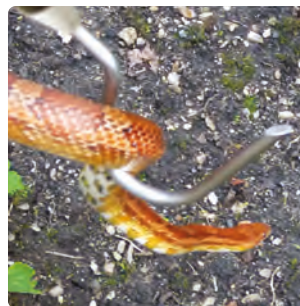

SPECIAL MODELS
ON DEMAND

Code	Model	Weight	Length
192466	Hook for reptiles	320 g	105 cm

■ TELESCOPIC HOOK FOR REPTILES

Telescopic hook for catching reptiles.

- Rubber handle.
- Lightweight.
- Adjustable length from 120 - 200 cm.
- 25 mm diameter plastic-covered steel tube.
- Tapered hook end.



TELESCOPIC I
INEXPENSIVE I EXTRA LONG
2 M

Code	Model	Weight	Length
192468	Telescopic hook for reptiles	670 g	120-200 cm

For reptiles equipment, request our *Distinfect Capture* brochure or download it on our website.



REPTILES CAPTURE SET

NEW

Multi-usage capture kit with removable accessories and hooks, suitable for capturing most species of snake.

Set content:

- 2 anodised aluminum poles 80 cm in length, comprising a quick-grip tip and an aluminum fitting for attaching the extension. These enable two hooks to be used simultaneously to obtain a better grip on the animal. **A**
- 1 anodised aluminum extension measuring 50 cm, can be screwed. **B**
- 1 short hook suitable for small snake species. **C**
- 1 standard hook. **D**
- 1 "flat-iron" hook, ideal for constrictors. **E**
- 1 hoop tip with non-traumatic, soft-leather strap, suitable for restraining on hard surfaces. **F**
- 1 V-shaped metal tip, suitable for restraining on soft surfaces. **G**

Characteristics:

- Hooks quick and easy to change.
- Lightweight and resistant, the kit can transport reptiles up to 25 kg.
- Non-traumatic thanks to the hooks' rounded edges.
- Compact and ergonomic, the entire kit is carried in a 81 x 23 x 10 cm case. **H**

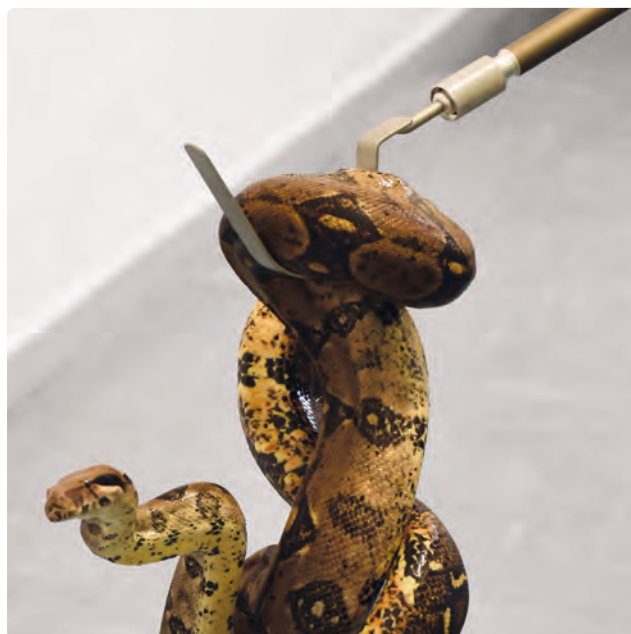

Code	Model
192467	Multi-usage reptiles capture set

ACCESSORIES

	Code	Model	Length	Use
A	192496	2 anodised aluminum poles	80 cm	-
B	192497	Extension for pole	50 cm	-
C	192490	Short hook	-	Small species
D	192491	Standard hook	-	All types
E	192493	'Flat-iron' hook	-	Constrictors
F	192494	Hooped tip with leather strap	-	Hard surfaces
G	192495	V-shaped metal tip	-	Soft surfaces
H	192080	ABS case	810 x 230 x 100 mm	-

ON DEMAND

	Code	Model
I	192492	Double hook



ON DEMAND | DOUBLE HOOK |

For reptiles equipment, request our *Distinfect Capture* brochure or download it on our website.

PROTECTIVE GLOVES FOR CATS

Protective gloves for catching cats or small animals: thick, soft, single skin leather.

- Provides protection from the forearm to the elbow.
- CE making.
- Total length 55 cm.



Code	Model	Weight	Length
192750	Protective gloves for handling small animals	445 g	55 cm

PROTECTIVE GLOVES FOR MONKEYS AND BIRDS OF PREY

Reinforced thick leather protective gloves for capturing and handling monkeys and birds of prey. Thick leather.

- Special reinforcement on top of the hand and forearm.
- CE making.
- Total length 65 cm.



Code	Model	Weight	Length
192752	Special protective gloves for monkeys and birds of prey	1.1 kg	65 cm

REINFORCED PROTECTIVE GLOVES

Reinforced protective gloves to capture animals.

- Exterior glove in green water-repellent cowhide, with reinforced palm and back. Interior glove in aluminised wool.
- 40 cm sleeve in pigmented hide, lined with chrome cowhide, canvas eyelet.
- Elbow open for greater comfort.
- CE making.
- Total length 65 cm.



Code	Model	Weight	Length
192754	Reinforced protective gloves	1.3 kg	65 cm

HIGH REINFORCED PROTECTIVE GLOVES

Strong reinforced protective gloves to capture aggressive animals (dogs, snakes, etc.).

- Soft, thick, triple-layer leather palms:
 - 2 layers of puncture-resistant material, in high tenacity polyester (material protecting against the risk of perforation, studied for bulletproof vests and fencing),
 - 1 cowhide leather layer.
- 40 cm pigmented crust cuff reinforced with a fang shock absorber.
- Elbow open for greater comfort.
- CE making.
- Total length 65 cm.
- Perforation resistance: 350 N according to EN13567.

The gloves are not approved for the capture of poisonous snakes.



Code	Model	Weight	Length
192756	High reinforced protective gloves	1.5 kg	65 cm

For capture clothing, request our *Distinfect Capture* brochure or download it on our website.



PROTECTION

Exploration gloves	122
Examination and surgery gloves	124
Exploration gel	125
Body protection	125

■ ECOGAN

Disposable polyethylene exploration gloves (25 µm).

- Without neck strap.
- Standard touch sensitivity.
- Green gloves.

Supplied by 100 gloves per dispenser box.

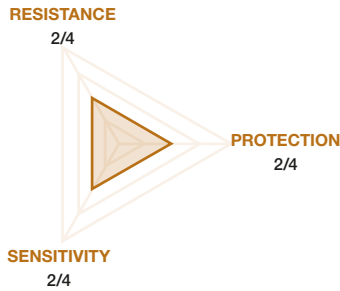

Code x 100	Length
307650 ●	95 cm

Outer packaging:
master case of 10 boxes

■ EXPLOGAN®

Disposable polyethylene exploration gloves (30 µm).

- Neck strap to prevent slipping.
- Good touch sensitivity.
- Orange gloves.
- Excellent balance between resistance and sensitivity.

Supplied by 100 gloves per dispenser box or bags of 50.

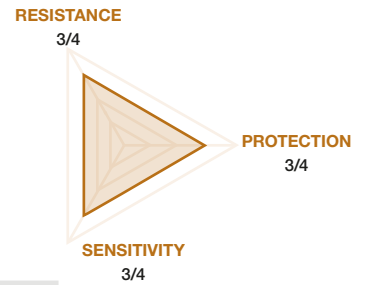

Code	Length	Pack.	O/pack.
307611 ●	95 cm	x 100	x 10
307613 ●	95 cm	x 50	x 50

■ SENSIGAN®

Disposable polyethylene exploration gloves (28 µm).

- With a neck strap to prevent slipping.
- Smooth surface for excellent touch sensitivity.
- Transparent gloves.

Supplied by 100 gloves per dispenser box.

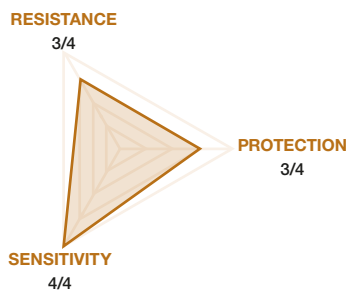

Code x 100	Length
307610 ●	95 cm

Outer packaging:
master case of 10 boxes

■ PROGAN®

Disposable polyethylene exploration gloves (30 µm).

- Without neck strap. Can be stretched to prevent slipping.
- Good touch sensitivity.
- Yellow gloves.
- Highly tear-resistant.
- Thin and strong seams.

Supplied by 100 gloves per dispenser box.

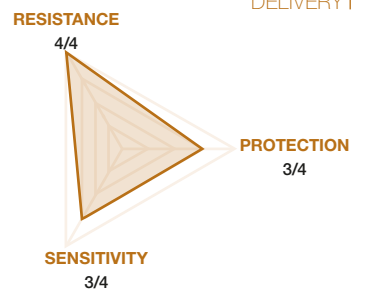

Code x 100	Length	Model
307626 ●	87 cm	S
307627 ●	90 cm	M
307629 ●	95 cm	L

Outer packaging:
master case of 10 boxes



■ AISOGAN®

Disposable polyethylene exploration gloves (25 µm).

- Armpit protection and slips over the neck.
- Excellent touch sensitivity, identical to Sensigan®.
- Transparent gloves.
- Maximum protection.

Supplied by 50 gloves per dispenser box.



■ MAXOGAN

Disposable polyethylene exploration gloves (25 µm).

- Armpit protection and slips over the neck.
- Standard touch sensitivity, identical to Ecogan.
- Green gloves.

Supplied by 50 gloves per dispenser box.

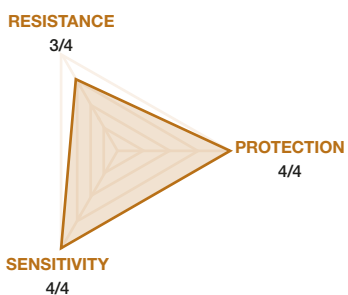

Code x 50 Length
307620 124 cm

Outer packaging:
master case of 10 boxes

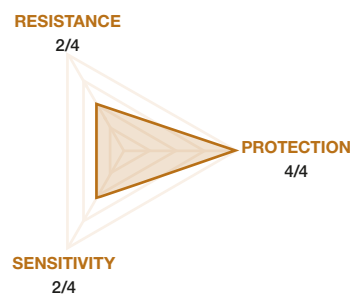

Code x 50 Length
307623 120 cm

Outer packaging:
master case of 10 boxes



EXAMED

Disposable examination gloves made from pre-powdered latex.

- Ambidextrous, strong, comfortable, non-sterile gloves.
- Smooth surface of natural latex with low protein content to limit allergenicity.
- Good stretchability > 650% elongation.
- Pre-powdered with absorbent USP grade cornstarch (non allergenic < 120 mg/g).
- Double dipped to reduce porosity.
- Porosity standard AQL* 1.5.
- Rolled edges.

Supplied by 100 gloves per dispenser box.

*AQL, or Acceptable Quality Level, defines the resistance of the glove to penetration by chemical and biological products. The lower the AQL, the better the glove.



Code x 100	Size
307760	6/7
307761	7/8
307762	8/9
307763	9/10

Outer packaging:
master case of 10 boxes



EXAMED POWDER-FREE

NEW

Powder-free disposable examination gloves made from latex.

- Ambidextrous, strong, comfortable, non-sterile gloves.
- Polymer coating on the outside.
- Good stretchability > 650% elongation.
- Double dipped to reduce porosity.
- Porosity standard AQL* 1.5.
- Rolled edges.

Supplied by 100 gloves per dispenser box.

*AQL, or Acceptable Quality Level, defines the resistance of the glove to penetration by chemical and biological products. The lower the AQL, the better the glove.



Code x 100	Size
307745	6/7
307746	7/8
307747	8/9
307748	9/10

Outer packaging:
master case of 10 boxes



SURGITEX

Anatomically-designed sterile latex surgical gloves, lightly powdered, with long cuffs.

- Natural latex with low protein content to limit allergenicity.
- Good stretchability > 850%.
- Length 290 mm for better protection of the lower surface of the forearm.
- Variable thicknesses to ensure strength and flexibility (0.23 mm thick at the palm, 0.21 mm thick at the wrist, 0.26 mm thick at the fingers).
- Micro-textured palm for improved grip on instruments.
- Lightly powdered with biodegradable USP grade cornstarch (non-allergenic): < 100 mg/g.
- Anatomically-designed fingers and thumb.
- Rolled edges for easier removal.
- Double wrapped in medical grade packages.
- Sterilised by gamma radiation.

Supplied by 50 pairs per dispenser box, i.e. 100 units.



Code x 100	Size
307698	6
307700	6.5
307702	7
307704	7.5
307706	8
307708	8.5

Outer packaging:
master case of 4 boxes



VETRILE

NEW

Single-use synthetic examination gloves, 100% nitrile, powder-free, non-sterile.

- New 100%-nitrile formula.
- Reduced allergy potential: free of latex proteins.
- Ambidextrous, resistant, non-sterile.
- Smooth surface and rolled edges.
- Durable: resistant to perforations and tears.
- Good elasticity: elongation percentage 600%.
- Antimicrobial barrier.
- Good performance to caustic chemicals, detergents, alcohol, and chlorhexidine.
- Porosity AQL* 1.5.
- Excellent price/performance ratio.

Supplied by 100 gloves per dispenser box.

*AQL, or Acceptable Quality Level, defines the resistance of the glove to penetration by chemical and biological products. The lower the AQL, the better the glove.



Code x 100	Size
307769	6/7
307770	7/8
307771	8/9
307772	9/10

Outer packaging:
master case of 10 boxes



p.46 Find our surgical instruments



■ EXPLOGEL®

Lubricating and protective gel for vaginal and rectal examinations, obstetric procedures, and ultrasound examinations.

- Fits in pocket without leaking.
- Non-spermicidal.
- Thicker texture.
- Squeeze bottle.

Supplied without pump.

NON
SPERMICIDAL



Code	Model	O/Pack.
227660	Explogel® 500 mL	x 20
227662	Explogel® 1 L	x 12
227664	Explogel® 5 L	x 2

ACCESSORIES

Code	Model
227666	5 L pump

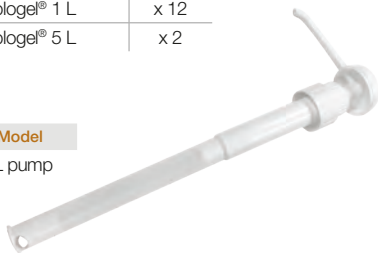

■ EKOGELE

Lubricating and protective gel for external and internal ultrasound examinations.

- Fits in pocket without leaking.
- Non-spermicidal.
- Thicker texture, lightly adherent.
- Works well with external and internal ultrasound probes.
- Excellent transmission quality.
- Squeeze bottle.

Supplied without pump.

FOR
ULTRASOUND



Code	Model	O/pack.
227682	Ekogel 1 L	x 12
227684	Ekogel 5 L	x 2

ACCESSORIES

Code	Model
227666	Pump 5 L



■ PROTECT

Professional quality, disposable, polyethylene protective gowns for caesareans, calving, ultrasound examinations, embryo transfers and necropsies.

- Long funnel-shaped raglan sleeves with tight forearm cuffs to provide a good seal.
- No back opening for better protection.
- Long and spacious for kneeling.
- Put on like a sweater, take off like a jacket after tearing it open from top to bottom.
- Size according to length.
- Suitable for food use (food-grade certificate declaring compliance with European regulations 1935/2004/EC, 2023/2006/EC and 10/2011/EC).
- Highly-resistant seams.

Supplied in bags of 24 units folded and individually wrapped.

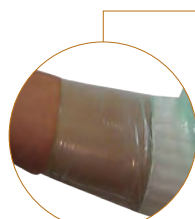

Maximum waterproofness



RESISTANT
NO TEAR

Code x 24	Model	Length	O/pack.
307880	< 160 cm	130 cm	x 6
307882	> 160 cm	140 cm	x 6
307884	> 175 cm	156 cm	x 6
307886	> 185 cm	165 cm	x 5



COMBIVET

Synthetic non-woven polypropylene fabric coveralls with hood, for farm visits and livestock handling.

- Non-woven polypropylene (45 g/m²).
- Washable several times at 40°C.
- Two 8 x 9 cm trouser pockets and one 13 x 12 cm chest pocket at the right.
- Zipper closure.
- Elastic at the waist, wrists and ankles.
- Navy blue colour.
- Odour-resistant.
- Watertight under normal use.

Supplied in individual bags.



Code	Size	Length	Hip width
307656	S	160 cm	65 cm
307658	M	171 cm	70 cm
307660	L	185 cm	78 cm

Outer packaging:
master case of 25 units

VELVET

Waterproof, reusable and milking gown made of polyester.

- Elastic at the wrists.
- Fastens in back with two velcro strips.
- Adjustable waist tie.
- Folded velvet collar.
- 1 chest pocket and 2 hip pockets with perforations for liquid drainage.
- Navy blue color.
- Machine washable (40°C).

Supplied in individual bags.



Code	Model	Length
307890	1	130 cm
307892	2	145 cm

POLYBOOT

Disposable plastic boot covers with elastics bands, for farms visits.

- 40.5 cm length and 50 cm high.
- Thickness: 40 µm.

Supplied by bags of 50.

MORE |
ERGONOMIC |

MORE |
RESISTANT |

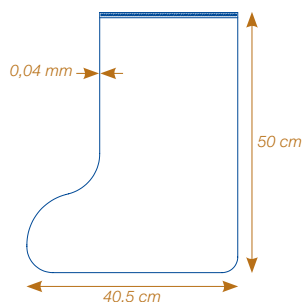

Code x 50	Model
307640	Polyboot

Outer packaging:
master case of 20 bags

BOUFFANT CAPS

Disposable non-woven polypropylene bouffant caps (14g/m²) with elastic band.

- Transparent.
- Elastic band for perfect fit.
- Light and airy material.
- Accordion folded for easy storage.

Supplied in bags of 100.



Code x 100	Model
307685	Bouffant caps

Outer packaging:
master case of 10 bags





HYGIENE

Instrumentation	128, 132
Surfaces	129, 132
Hand cleaning	130

INSTRUMENTATION

■ GÉNIA CLEAN CLEANSING POWDER

Pre-sterilisation enzymatic disinfectant for reusable medical and surgical INSTRUMENTS.

- Composition: cationic and non-ionic surfactants, calcium sequestrants, proteolytic enzymes, disinfectant, perfume.
- Spectrum of activity*: bactericidal, viricidal and fungicidal.
- Use: **cleaning and pre-disinfection** of instruments, flexible and rigid endoscopy material and all invasive and non-invasive medical devices straight after use.
- Contact time: **15 minutes at 0.4% or 5 min at 0.5%.**
- The diluted solution can be stored for 24h.
- Reinforced effectiveness thanks to the enzyme activity and the alkaline pH of the solution.
- Gentle on the instruments, it destroys the biofilm and controls limescale.
- Compatible with ultrasound baths.



0.4 %:
1 KG = 250 L
OF READY-TO-USE SOLUTION
ACTIVE IN 15 MIN

0.5 %:
1 KG = 200 L
OF READY-TO-USE SOLUTION
ACTIVE IN 5 MIN



INSTRUMENTATION

Code	Model
317446	1 kg bucket

Outer packaging:
master case of 4 units



Fact sheets and safety data sheets available on demand.

PROTOCOL FOR CLEANING AND PRE-DISINFECTION OF SURGICAL INSTRUMENTS AND SUBMERSIBLE MEDICAL DEVICES



Description

Immersion cleaning and pre-disinfection immediately after use.

Spectrum of activity

Bactericidal, virucidal and fungicidal.

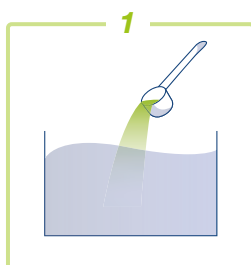

Using the scoop, measure the amount of detergent powder and incorporate it into your dose of hot water at 40°C according to the desired concentration:
- 0.4% = 4 g per liter of water,
- 0.5% = 5 g per liter of water.
Compatible with ultrasonic tanks.

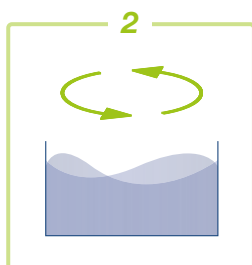

Stir the solution.

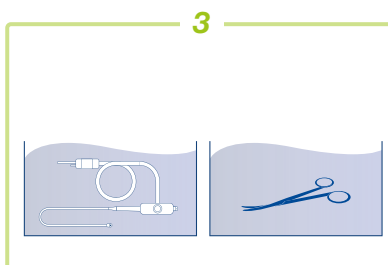

Immerse and irrigate medical devices. Contact time: according to manufacturer's recommendations.

Most frequent case:
- 15 minutes at 0.4%
- 5 min at 0.5%

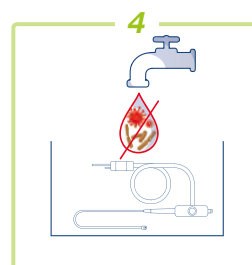

Rinse thoroughly with **bacteriologically controlled network water**. Renew the preparation as soon as it is soiled or at the latest **every 24 hours**.

Find our protocols on product labels, Génia Clean brochures and on the website.



SURFACES

GÉNIA CLEAN SURFACE CLEANSING SPRAY

Cleaning, disinfecting of SURFACES with high contamination risk. Ready to use.

- Composition: alkylamine in hydro-alcoholic solution, amphoteric surfactants, perfume.
- Spectrum of activity*: bactericidal, fungicidal, viricidal. Product active on enveloped viruses such as the covid-19 virus.
- Contact time: **immediate actions thanks to its surfactants.**
- Grapefruit fragrance.
- Quick-drying, no residue.

WORKS | IMMEDIATELY

FAST | DRY



SURFACES

Code	Model	O/pack.
317408	1 L spray	x 12
317410	5 L refill	x 4

GÉNIA CLEAN DISINFECTANT FOAMING SPRAY

Ready-to-use SURFACES disinfectant foaming spray.

- Composition: ethyl alcohol and alkyldimethylbenzylammonium chloride, perfume.
- Spectrum of activity*: bactericidal, fungicidal, viricidal. Product active on enveloped viruses such as the covid-19 virus.
- Contact time: **5 minutes.**
- No-rinse, no residue, quick-drying.
- Grapefruit fragrance.

FAST | DRY

FOAMY | TEXTURE



SURFACES

Code	Model	O/pack.
317440	750 mL spray	x 12
317442	5 L refill	x 4

INSTRUMENTATION

GÉNIA CLEAN IODINE REMOVER

Ready-to-use iodine remover for floors, surfaces, fabrics and medical equipment.

- Removal of all types of iodine traces, whether old or new.
- Remedial or preventative use without scrubbing.
- Free from colourants and perfumes.
- Can be used in a washing machine.



INSTRUMENTATION AND SURFACES

Code	Model
317412	500 mL spray

Outer packaging:
master case of 12 units

NEW

GÉNIA CLEAN FLOOR DISINFECTANT

Powerful disinfectant of FLOORS and surfaces, for dilution.

- Composition: alkyldimethylbenzylammonium chloride 6.32% (w/w) (CAS 68424-85-1), didecyldimethylammonium chloride 1.19% (w/w) (CAS 7173-51-5), glutaraldehyde 10.27% (w/w) (CAS 111-30-8).
- Spectrum of activity*: bactericidal, viricidal, fungicidal in accordance with the rules in relation to TP3 and TP4. Active on viruses relevant to veterinary practice, including **parvovirus** and **calicivirus**.
- Uses: Product intended for the sanitation of floors and surfaces in a veterinary setting.
- ECOCERT label: the product can be used in organic farming and has been developed to be both effective and environmentally-friendly.
- Bactericidal effect at 0.4% and viricidal effect at 1.25%.

EFFECTIVE | ON PARVOVIRUS | AND CALICIVIRUS

5L = UP TO 1250L OF | ACTIVE SOLUTION



FLOORS AND SURFACES

Code	Model
317444	5 L can

Outer packaging:
master case of 4 units



Fact sheets and safety data sheets available on demand.

Find our protocols on product labels, Génia Clean brochures and on the website.



HANDS

■ GÉNIA CLEAN GENTLE CLEANSING LOTION

Cleansing lotion that is gentle on skin, for frequent use.

- Composition: water, sodium laureth sulfate, sodium chloride, glycerine, cocobetaine, coco-glucoside, glyceryl oleate, sodium lauryl sarcosinate, citrus aurantium dulcis, sodium hydroxyde, peg-40 hydrogenated castor oil, propylene glycol, tocopheryl acetate, retinyl palmitate, aesculus hippocastanum seed extract, panthenol, linseed acid, helianthus annuus seed oil, sorbitol, bht, stearic acid, methylchloroisothiazolinone, methylisothiazolinone, citric acid, tocopherol, hydrogenated palm glycerides citrate.
- Excellent cleansing power.
- Glycerine and vitamin complex (vitamins A, E and F) combine to moisturise and protect skin.
- Neutral pH formula.
- Hypoallergenic, fragrance-free, colourless formulation.
- Used for:
 - Simple washing (30 sec.)
 - Antiseptic handwashing (1 min.)
 - Surgical scrub: 3 minutes followed by hydroalcoholic friction carried out twice (two times, 1 minute each time).

HYPOALLERGENIC |

NEUTRAL PH |
FORMULA |

LEAVES |
THE SKIN SOFT |



HAND CLEANING

Code	Model	O/pack.
317420	1 L bottle	x 6
317422	5 L container	x 2

■ GÉNIA CLEAN HAND GEL

Rapid hand sanitiser, no rinsing or wiping.

- Composition: propane-2-ol, ethanol, water, glycerine, gelling agent and triethanolamine.
- Spectrum of activity*: bactericidal, fungicidal, viricidal.
- Contains an emollient to moisturise and prevent skin irritation.
- Neutral pH formula.
- **Hypoallergenic**, fragrance-free, colourless formulation.
- Used to disinfect hands:
 - before medical examination
 - before a surgical intervention
 - at the counter, available for the customers

HYPOALLERGENIC |

NEUTRAL PH |
FORMULA |



HAND CLEANING

Code	Model
317414	500 mL bottle

Outer packaging:
master case of 12 units

Fact sheets and safety data sheets available on demand.
Find our protocols on product labels, Génia Clean brochures and on the website.

PROTOCOL

• Hand-rubbing hygiene

1. Apply **3 ml** of Génia Clean hydroalcoholic gel to clean and dry hands.
2. Rub your hands and forearms for **30 seconds**.

• Surgical scrub

1. Clean hands with Génia Clean gentle washing lotion for **3 minutes**.
2. Apply **4.5 ml** of Génia Clean hydroalcoholic gel to clean and dry hands.
3. Rub your hands and forearms, including elbows, for **1 minute**.
4. Carry out a **second scrub** with **4.5 ml** for **1 minute**, excluding elbows.

For complete instructions, please refer to the product label or to the handwashing guide available of the internet site www.genia.fr.

■ SURGICAL BRUSH

Surgical brush with sponge and nail cleaner.
Individual sterile packaging.

Supplied in bag of 25.









Code x 25	Model
317205	Dry

Outer packaging:
bag of 25 units



Génia[®] clean

USER GUIDE FOR GÉNIA CLEAN PRODUCTS

USE	PRODUCT NAME	Code Génia	Pack.	DESCRIPTION	SPECTRUM OF ACTIVITY					
					BACTERICIDAL	VIRUCIDAL	FUNGICIDAL / YEASTICIDAL			
INSTRUMENTATION		317446	1 kg	Enzymatic powder for decontamination of surgical equipment and instrumentation before sterilization.	X	X	X			
					0.50%		0.40%			
					5 minutes		15 minutes			
SURFACES		317408	1L	Disinfectant spray for high contamination risk surfaces.	X	X Including parvovirus and vaccine virus*	X			
		317410	5L					5 minutes : Immediate action thanks to its surfactants.		
		317440	750 mL	Surfaces disinfectant foaming spray.	X	X Including vaccine virus*	X			
		317442	5L					5 minutes		
		Floor disinfectant	317444	5L	Powerful disinfectant for floors	X	X Including parvovirus and calicivirus	X		
									0.40%	1.25%
5 minutes									30 minutes	15 minutes
HANDS		317414	500 mL	Rapid hand sanitiser, no rinsing or wiping.	X	X Including vaccine virus*	X			
				30 secondes						
		317420	1L	Cleansing lotion that is gentle on skin, for frequent use.						
		317422	5L							
FABRICS		317412	500 mL	Ready-to-use iodine remover for floors, surfaces, fabrics, medical equipment.						

The Vaccine virus is the annexes for envelopped viruses presented in the annexes of the standards EN 14476 + A2 (2019) and EN17111, such as: All coronaviruses.

For full instructions, refer to the label on the back of the product.
Find all the technical and safety data sheets on the website www.genia.fr



INSTRUMENTATION

■ ALKAZYME

Proteolytic alkaline detergent (pH 10.5) for pre-disinfection and immersion cleaning of medical and surgical instruments, heat-sensitive endoscopic devices and probes, before chemical disinfection or sterilisation.

- Composition: didecyl dimethyl ammonium chloride, proteolytic enzyme, calcium carbonate sequestrant, non-ionic surfactant.
- Bactericidal and yeast-killing agent.
- Alkazyme attacks and eliminates the bacterial biofilm consisting of proteins and substances secreted by microorganisms adhering to surfaces and surfaces colonised by bacteria.
- Safe for ultrasonic tanks.
- Soaking time: 15 min in 40°C water, open surgical instruments.
- Dilution: 0.5%, equal to 200 L of solution per kg.



Code	Model	O/pack.
317247	Single use packets 12 x 20 g	x 42
317248	750 g bucket	x 6
317250	2 kg bucket	x 6

■ BIONET

Powered non-ionic detergent, and alkaline sodium and trisodium phosphate salts for washing surgical instruments, laboratory equipment, work surfaces and benches without brushing.

- Powerful detergent with instant action.
- Biodegradable.
- Destroys pyrogens, eliminates blood traces, tissues and other organic and mineral materials.
- Prepare surgical instruments for optimal (chemical) cleanliness before sterilisation.



Code	Model
317210	1 L bottle

Outer packaging:
master case of 15 units

SURFACES

■ BETANETT

Stain remover to remove iodine stains from floors, surfaces, textiles. Ready to use.

- Spray on the stain and let it work.
- Safe for washing machines.



Code	Model
317256	500 mL spray

Outer packaging:
master case of 12 units





LIVESTOCK

Drenching

Drenching guns	134
Drenching syringes	136
Accessories	138

Large animals restraint	140
--------------------------------------	------------

Large animals identification	141
---	------------

Reproduction

Castration	142
Calving	143
Lactation care	145
Dehorning	146
Measuring and diagnosis instruments	147

Equine dentistry	149
-------------------------------	------------

Bloat

Trocars	150
Oesophageal catheters	151
Magnet and bolus applicators	152

Foot care

Hoof knives, farrier range	154
Hoof knives, veterinary range	155
Accessories	156

DRENCHMASTER® & APPLIMASTER®

80 mL automatic drenching guns.

- Ergonomic and innovative design.
- Fast, accurate and ambidextrous dose setting.
- Easy to view black volume markings.
- Comfortable grip.
- Fast flow of liquids.
- 2.5 mL graduations.
- Interchangeable nozzles and washers.

Supplied in a polyethylene bag with 1.5 m of tubing, an additional washer, instructions for use and a 10 mL silicone oil bottle. On demand: other capacities and customisations.

DRENCHMASTER® (DRENCHING)

Code	Model	Nozzle diameter	Length	Pour-on nozzle diameter
A 190000	Drenching gun with plastic nozzle	15 mm	180 mm	-
190002	Drenching gun with brass nozzle	10 mm	180 mm	-
190004	Drenching gun with chrome-plated nozzle	10 mm	180 mm	-
190010	Drenching gun with plastic nozzle	15 mm	180 mm	10 mm
190012	Drenching gun with brass nozzle	10 mm	180 mm	10 mm

APPLIMASTER® (POUR-ON)

Code	Model	Length	Pour-on nozzle diameter
B 190006	Applicator with pour-on nozzle	100 mm	10 mm
C 190008	Applicator with pour-on nozzle	450 mm	10 mm
D 190015	Pour-on nozzle only	450 mm	10 mm

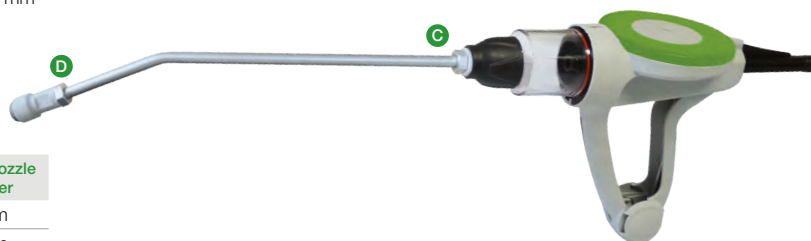

p.139 Find backpack tanks and washers



PISTOLMAN

Universal manual (or automatic for 20, 50 and 70 mL models) drenching guns with interchangeable barrels.

- Accurate, fast adjustment via the rear nut.
- 20, 50 and 70 mL models can be converted into automatic models or pour-on and automatic hypodermics by replacing the solid plunger with a perforated one and adding the front and rear valve assembly.
- High-tech, heavy-duty plastic.
- Can be entirely disassembled for cleaning.
- Barrels are transparent, resistant to boiling water, with indelible, engraved graduations.
- Brass and chrome-plated nozzles with a reinforced wall and olive fitting at one end.
- Aluminium nut for easier, more accurate positioning of the cannula and good sealing.
- Galvanised steel handle springs colour-coded according to capacity.
- Silicone o-rings.
- All parts easy to clean.
- Compatible for use with standard pharmaceutical products.

Supplied in a polyethylene bag, with a nozzle, instructions for use, an additional ring and a 10 mL silicone oil bottle.



Brass nozzle Code	Chrome plated nozzle Code	Nozzle model	Capacity	Nozzle diameter	Graduation
180060	180300	Short	20 mL	6 mm	1 mL
180065	180302	Short	50 mL	10 mm	2 mL
180070	180305	Short	70 mL	10 mm	5 mL
180072	180306	Long	70 mL	10 mm	5 mL
180075	180308	Long	150 mL	10 mm	10 mL
180079	180310	Long	250 mL	12 mm	25 mL
180078	-	Long	250 mL	18 mm*	25 mL

*only for thick products.

[p.138 Find our drenching nozzles](#)

PISTOLMATIC

Automatic drenching guns identical to manual models, with front and rear valve assembly.

- Identical to manual models.
- Front and rear anodised aluminium valve assembly can be entirely disassembled.
- Ground and polished plastic ball bearings and stainless steel springs.
- Can be converted to a manual model by removing the plunger and the front and rear valve assembly and replacing the perforated plunger with a solid one.
- Can be converted to a hypodermic model with a reducer (code **189624** p.138) and Luer-Lock, Recordfix or Rotlauf hub (p.16); or a pour-on by adding a nozzle (code **186044** p.138).

Supplied in a polyethylene bag with a nozzle, 1.5 m of 7/11 mm tubing, instructions for use, an additional set of rings and valves, and a 10 mL silicone oil bottle.



Brass nozzle Code	Chrome plated nozzle Code	Nozzle Model	Capacity	Nozzle diameter	Graduation
180080	180314	Short	20 mL	6 mm	1 mL
180085	180320	Short	50 mL	10 mm	2 mL
180087	180324	Short	70 mL	10 mm	5 mL
180090	180326	Long	70 mL	10 mm	5 mL

[p.138 Find our washers](#)

[p.139 Find our valve assembly sets](#)

HYPODERMIC PISTOLMATIC

Hypodermic guns identical to automatic models, with monobloc Luer-Lock hub.

Supplied in a polyethylene bag with 1.5 m of 7/11 mm tubing, instructions for use, an additional set of washers and valves, and a 10 mL silicone oil bottle.



Code	Capacity	Graduation
180095	20 mL	1 mL

[p.18 Find our hypodermic needles](#)

POUR-ON PISTOLMATIC

Pour-on guns identical to automatic models with a short 25 mm nozzle (code 186044 p.138).

Supplied in a polyethylene bag with 1.5 m of 7/11 mm tubing, instructions for use, an additional set of washers and valves, and a 10 mL silicone oil bottle.



PISTOLMATIC POUR-ON

Code	Capacity	Graduation
180110	20 mL	1 mL
180115	50 mL	2 mL
180117	70 mL	5 mL

POUR-ON NOZZLE

Code	Nozzle diameter	Length
186044	10 mm	25 mm



■ DRUGMATIC

Moulded plastic automatic syringes with engraved graduations on the barrel. Can be entirely disassembled. Sterilisation: resistant to boiling water.

- Identical to Tubmatic® syringe (p.12).
- Silicone plunger washers that also fit the metal Tubmatic® and Flamatic® syringes (p.139).
- Chromed brass hub.

Supplied in a polyethylene bag with a 6 mm diameter brass nozzle, 1.5 m of 4/7 tubing, instructions for use, washers and valves set, and a 10 mL silicone oil bottle.



Code	Inside diameter	Model	Capacity	Graduation
180002	9 mm	With tubing	2 mL	0.1 mL
180004	14 mm	With tubing	5 mL	0.5 mL

ACCESSORIES

Code	Model
106196	Ball, spring and washer set (common to all models)

[p.12 Find our Tubmatic® syringes](#)

■ ORALPLEX

Drenching syringes for sheep and goats, with eccentric hubs and short 6 mm x 120 mm brass nozzle.

- Models fitted with a metal insert to protect the screw thread from the tank.

Supplied in a polyethylene bag with instructions for use and a 10 mL silicone oil bottle.

Elplex® model
(plastic plunger and cap)

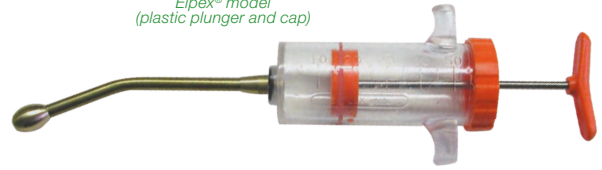

Metalplex® model
(metal plunger and cap)



Code Métalplex®	Code Elplex®	Capacity	Nozzle diameter
180030	180020	50 mL	6 mm - Luer-Lock
180032	180022	50 mL	6 mm - with screw
-	180018	30 mL	6 mm - with screw
180028	-	20 mL	6 mm - with screw
180026	-	20 mL	6 mm - Luer-Lock

[p.10 Find our Métalplex® and Elplex® syringes](#)

[p.17 Find our drenching nozzles](#)

■ GÉNIAPLEX 300 ML DRENCHING SYRINGE

Plexiglas drenching syringes for professionals.

- Identical to Géniaplex 300 mL syringe (p.8).

Supplied individually in a polyethylene bag with an additional plunger washer, a 10 mm diameter brass nozzle for cattle and a 10 mL silicone oil bottle.



Code	Model
180052	Drenching syringe 300 mL
109270	Washer (40-50) x 6

[p.139 Find drenching washers](#)

[p.8 Géniaplex 300 mL syringes can be converted into hypodermic syringes by replacing the nozzle with a reducer \(ref.189625 p.8\) and a hub \(p.16\).](#)

■ SYRMAN

Translucent plastic drenching syringes with indelible engraved graduations.

- Resistant to boiling water.

Supplied in a polyethylene bag with an additional washer and a 10 mL silicone oil bottle.

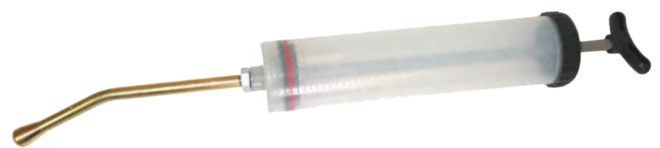

Code 300 mL	Code 450 mL	Model
180050	180057	Drenching syringe with brass nozzle for cattle
180330	180336	Drenching syringe with chrome-plated nozzle for cattle
180049	180058	Drenching syringe + reducer + Luer-Lock hub, bibloc
180056	180059	Drenching syringe without nozzle
180055	-	Drenching syringe + Uterine catheter hub (code 187032)

[p.11 Syрман syringes can be converted into hypodermic syringes by replacing the nozzle with a reducer \(ref.189625 p.8\) and a hub \(p.16\).](#)



■ AGRIPLAST 100 ML

Syringe with flexible drenching nozzle attachment instead of hub.

- Cannulas designed for feeding pigeons.

Supplied in a polyethylene bag with a silicone flat cut washer.



Code	Model
107509	Syringe with a Luer-Lock hub + flexible nozzle
107510	100 mL Luer-Lock syringe only
107511	11.5 cm flexible drenching nozzle, 10 mm diameter, only

Outer packaging:
master case of 100 units

■ FEEDING SYRINGES

Disposable 50/60 mL feeding syringes for lambs.

- 1 mL graduations.
- Concentric hub.
- 6 mm diameter and 31 cm long feeding tube.



Code	Model	Pack.	O/pack.*
107031	Complete kit	unit	-
317136	Tube only	x 10	-
107154	Dispoject® feeding syringe only	x 30	x 12

*Number of boxes

p.14 [Find our Dispoject® syringes](#)



■ FORCE-FEEDING NOZZLES

Force-feeding nozzles for birds.

- Stainless steel with Luer-Lock hub.
- Fit all types of syringes.

Supplied by 12.



	Code x 12	Model	Length	Diameter
A	307135	Straight	50 mm	2.5 mm
B	307136	Straight	80 mm	2.5 mm
C	307138	Curved	60 mm	1.5 mm
D	307139	Curved	80 mm	2.5 mm
E	147086	Blunt	50 mm	0.9 mm



DRENCHING GUN NOZZLES

Brass and chrome-plated steel nozzles with reinforced walls and an olive connector at the end.

The reducer and the nozzles are supplied individually with a washer.

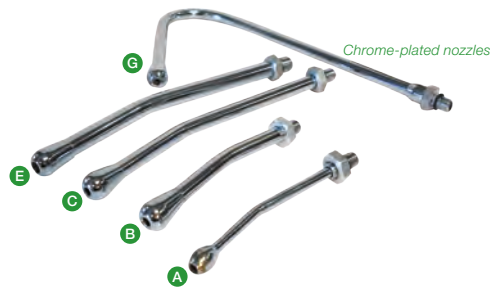
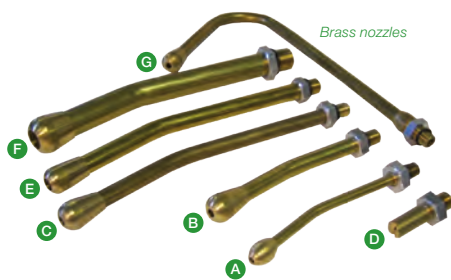

	Brass nozzle code	Chrome-plated nozzle code	Diameter	Use	Length	Capacity
A	187038	186048	6 mm	Lamb	105 mm	20 mL
B	187042	186050	10 mm	Sheep	105 mm	50/70 mL
C	187040*	186052*	10 mm	Cattle	180 mm	70/150 mL
D	186044	-	10 mm	Pour-on	25 mm	20/50/70 mL
E	187044	186054	12 mm	Cattle	180 mm	250 mL
F	187046	-	18 mm	Cattle	180 mm	250 mL
G	186046	186056	10 mm	Cattle	220/140 mm	20 to 250 mL

*For 300 and 450 mL drenching guns + syringes

	Code	Model	Capacity	Nozzle diameter
H	189646	Nozzle positioning screw nut for gun	20 to 150 mL	10 mm
H	189645	Positioning screw nut for nozzle	150 mL	12 mm
H	189647	Positioning screw nut for nozzle	250 mL	18 mm
I	189625	Reducer with needle hub washer	150 mL*	10 mm
I	189624	Reducer with needle hub washer	250 mL	12 mm

*For Géniaplex 300 mL (p.8), Pistolman and Pistolmatic (p.135), Syrman (p.136) syringes.

p.135 Find our drenching guns

TUBING WITH CAP

1.5 m 7/11 or 4/7 PVC tubing with cap, for automatic drenching guns.

- Attaches directly to the bottle and the automatic gun.
- Assembled set, including 2 tubes and a cap with adapter.

The weight and 2 springs are optional.

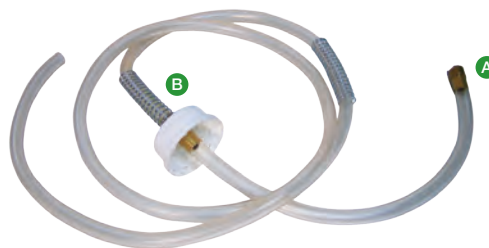

ON DEMAND: SUPPLY CAPS AND TELL US THE LENGTH OF THE TUBING TO REACH THE BOTTOM OF THE BOTTLE

	Code	Model
	180141	4/7 tubing for thin substances
	189676	7/11 tubing for thick substances
A	189674	Weight
B	189690	Spring

SET OF BARRELS FOR DRENCHING GUNS

Each set contains one barrel, one or two plungers, one adapter, one washer, one spring, instructions for use and a 10 mL silicone oil bottle.

- These sets of barrels fit all manual and automatic hypodermic and pour-on guns. They are used to obtain different volumes from a manual or automatic gun.

Supplied in polyethylene bag.



Automatic barrels



Manual barrels

SETS FOR MANUAL GUNS

Code	Capacity	Nozzle diameter
186010	20 mL	6 mm
186012	50 mL	10 mm
186014	70 mL	10 mm
186016	150 mL	10 mm
186017	250 mL	12 mm
186018	250 mL	18 mm

SETS FOR AUTOMATIC GUNS

Code	Capacity
186020	20 mL
186022	50 mL
186024	70 mL

p.135 Find our drenching guns

VALVE ASSEMBLY SETS FOR GUNS

Valve assembly set to convert a 20, 50 or 70 mL manual model into an automatic one.

- To convert an automatic model into a manual one, replace the solid plunger with a perforated one. Add the front and rear valve assemblies after removing the plug on the rear handle and the front nozzle. Finally, screw the nozzle on the valve assembly.

- The front valve assembly holds the 6 and 10 mm drenching nozzles as well as the pour-on nozzle together with the reducer (ref 189624 and 189625 p.138), and Luer-Lock, Recordfix, Rotlauf hubs (p.16).

Supplied individually in a polyethylene bag with 1.5 m of 7/11 tubing and instructions for use. The reducer and the hubs are supplied separately.



	Code	Model
	186060	Valve assembly set (front and rear)
	186062	Complete set of washers, ball bearings and springs

p.16 Find hubs



DRENCHING WASHERS

Drenching washers for Drugmatic, Oralplex, 300 mL Géniaplex drenching syringes, Syrman and other Génia drenching guns.

- Silicone washers moulded according to Génia's standards, extra-strong, with constant shore hardness across the entire surface. Water-resistant, non-stick.
- Guaranteed perfect seal and a smooth sliding of the plunger.

Supplied by 6.

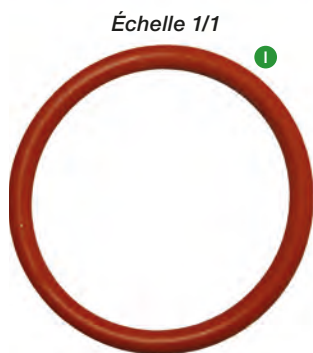

O-ring washer Syrman
300/450 mL

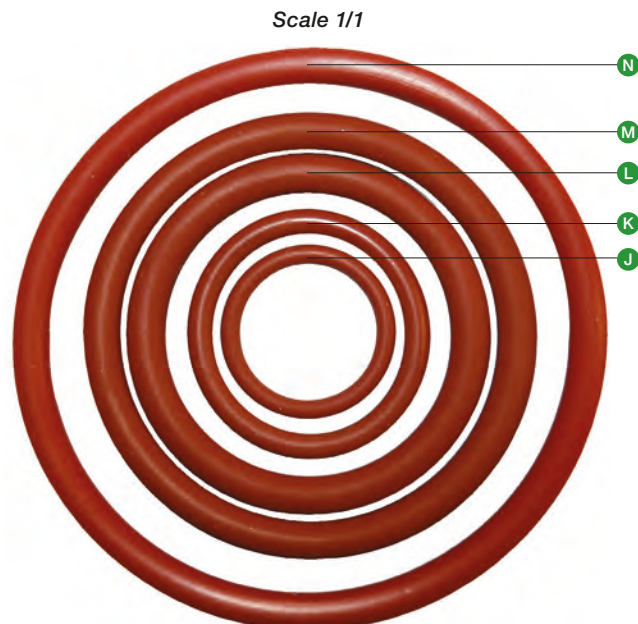

O-ring washers
For drenching guns

Code x 6	Model	Capacity	Washers
C 109265	Drugmatic	2 mL	9-14
D 109266	Drugmatic	5 mL	14-20
G 109269	Oralplex	50 mL	30-40
H 109270	Géniaplex	300 mL	40-50
I 189501	Syrman	300/450 mL	-
J 189503	Drenching gun	20 mL	-
K 189506	Drenching gun	50 mL	-
L 189509	Drenching gun	70 mL	-
M 189512	Drenching gun	150 mL	-
N 189514	Drenching gun	250 mL	-



Flat washers

INJECTION HARNESS

Multi-purpose harness (injection, Pour-On or drenching) designed for operator comfort and safety.

- Two chest pockets with double zip, able to receive bottles up to 500 mL.
- One back pocket receiving tanks up to 5L (Pour-On, drenching)
- Belt equipped with two adjustable pockets (clean and used needles) and a holster to secure an automatic syringe.
- Machine washable and fast drying.

Supplied individually with two carabiners hook.



Code	Model
227296	Injection harness

p.134 [Find our drenching syringes](#)

BACKPACK TANKS

Small backpack tank with an integrated air intake and an olive connector, for 7/11 mm tubing.

Supplied with air intake cap and straps. **B**



	Code 2.5 L tank	Code 5 L tank	Description
A + B + C	187003	187007	With straps
A + B	187009	187010	Without straps

ACCESSORIES

Code	Description
C 187011	Pair of straps for 5 and 2.5 L.
B 187006	Air intake cap 5 and 2.5 L.



VILLETTE®

Villette® electric prods for professionals high voltage, low current shocks offer greater efficacy and safety.

- Reliable, repairable, safe prods.
- Works with:
 - AP: 3 LR6 batteries
 - SRP: 4 LR6 batteries
 - ASRP: 1 6LR61 batteries

Supplied individually, without battery, in a blister pack.



Code	Model	Tension	Poid
221000	AP	3000 Volts	Animal weighing less than 150 kg
221002	SRP	4500 Volts	Animal weighing between 150 kg and 450 kg
221003	ASRP	6000 Volts	Animal weighing between 450 kg and 900 kg

HOG CATCHER

Restraint devices for pigs.

- Stainless steel bar.
- Chrome-plated brass heads.
- Plastic handles.
- Twisted and galvanised steel wire.
- Secure rear wire attachment.

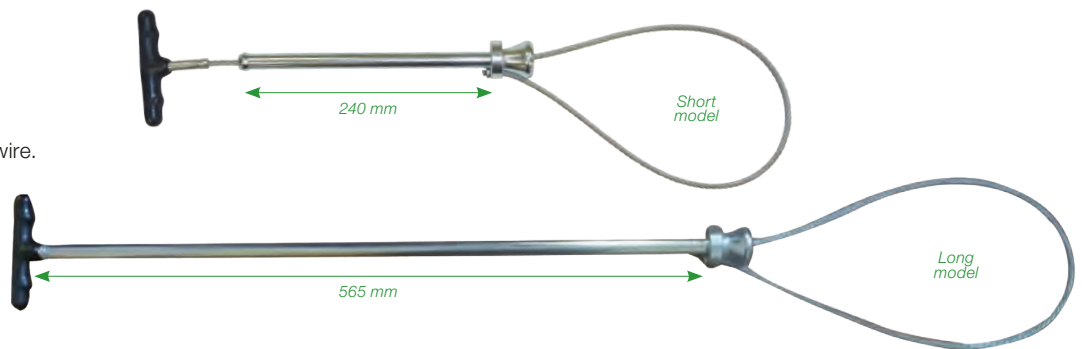

Code	Model	Length
227340	Short	24 cm
227342	Long	56.5 cm

COW LIFT

Durable, strong cow lift. To raise and support weakened cattle (e.g. during difficult calving).

- Covered side clamps to prevent injuries.
- Any animal can be raised using a hoist or any other device.
- Galvanised steel.
- Tubular PVC sheath.
- Easy to position.
- Essential for any dairy cattle farm.
- Maximum weight 900 kg.

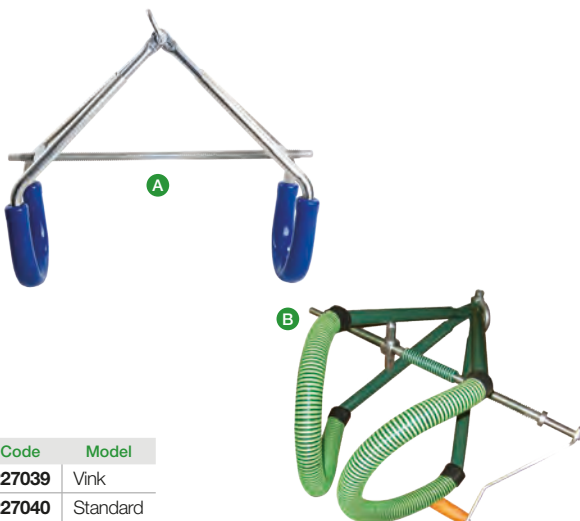

Code	Model
A 227039	Vink
B 227040	Standard

BULL LEADS



Code	Model	Length
A 227028	With hook	19 cm
B 227029	With chain	19 cm
C 227030	With slider	20 cm



PENMARK®

High quality marker pens for cattle, sheep, goats and pigs. **A**

Marker pen holder frees up both hands. **B**

- Velcro band for hand fitting.
- Machine washable Neoprene.
- With recoil restraint to hold the marker pen in place.

Supplied by box of 10.



Code x 10	Model
227630	Blue
227632	Red
227634	Green
227636	Purple
227638	Black
227640	Yellow

Outer packaging:

master case of 5 boxes of 10



ACCESSORIES

Code	Model
129280	Set of 4 markers (red, blue, purple, green)
227628	Penmark® holder

IDENTIX SPRAY

Marking spray (dye) for cattle, pigs, sheep and goats.

- Marking lasts for at least 3 weeks.
- Fast-drying, non-drip.
- Disappears when washed at 40°C, does not damage wool.

Supplied by box of 12.



Code 200 mL x 12	Code 400 mL x 12	Colour
227510	227520	Red
227512	227522	Green
227514	227524	Blue

LEG BANDS

• Length: 35 cm; Width: 2.5 cm.

Supplied in a polyethylene bag of 10 units.



Code x 10	Colour
277600	Orange
277606	Blue

TATTOOMARK

Industrial black tattooing ink to mark pigs.



Code	Model
220902	1 L

Outer packaging:

master case of 12 units



■ CASTRATOR

Burdizzo castrator for cattle and sheep.



	Code	Model	Length
A	307996	Sheep	23 cm
	307999	Sheep/Calves	30 cm
	307994	Cattle	34 cm
B	308001	Cattle	40 cm
	307997	Cattle	48 cm
	307995	Cattle	48 cm (above)

ACCESSORIES

	Code	Model
C	308002	Kneepad for castrating pliers

■ REIMER'S AND SAND EMASCULATORS

Stainless steel Reimer's and Sand emasculators for horses. Smooth jaws.

- Can be entirely disassembled.
- Double emasculation.
- Extended locking tab.
- Separate, sharpened cutting arm (Reimer's)



	Code	Model	Length
A	307978	Sand	32 cm
B	307990	Reimer's	32 cm

■ EMASCULATORS

Two piece beech set for castrating foals and ponies. Supplied in bulk.



Code	Model	Length
307983	Straight	16 cm
307986	Straight	20 cm
307987	Straight	24 cm
307988	Curved	24 cm

■ CHERON FORCEPS

Angled 25 cm stainless steel forceps for manipulating insemination straws.

- Can also be used as a swab holder or compress holder for obstetric disinfection before examination or for treating wounds.

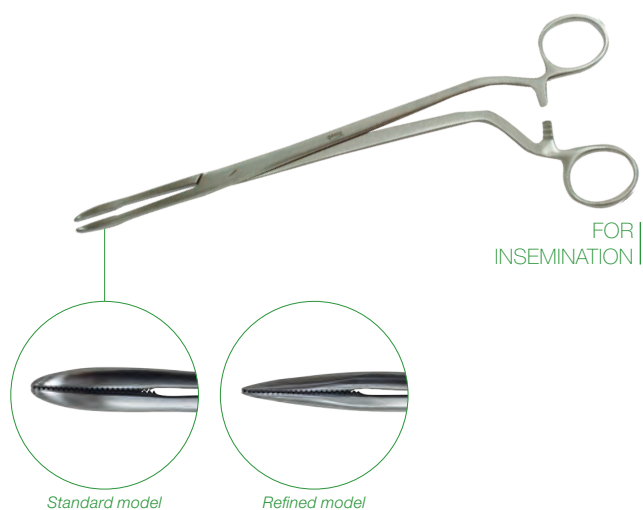

Code	Model	Length
657040	Standard	25 cm
657041	Refined	25 cm



■ GENIA CALF PULLER

Calf puller, with strong, reliable ratchet and pole, suitable for all types of calves, even large ones.

- Alternative ratchet motion.
- Enables pulling of the limbs of the calf one after the other. This facilitates delivery and minimizes the risk of pelvic obstruction.
- The ergonomic and adjustable breechen of the calf puller provides a strong grip on the animal and prevents slipping.
- The high mobility of the breechen.
- Quick release hooks in case of complications give great freedom of action during calving.
- Composition: chrome-plated steel tube.

Supplied with two calving chains and two hooks.

Code	Steel tube length
227037	1.8 m



■ PLASTIC MILK SUCKING PREVENTOR

Plastic milk sucking preventor for calves and young cattle, double closure for secure hold.

- Sealed with one hand and without tools which allows the anti-sucker to be placed singly.
- Anti-lifting tips to prevent detachment.
- Three locking notches to fit any nose size.
- Can be easily removed by lifting the notched tab.
- Strong plastic resistant to traction and impact.
- Screw-free, will not rust, break, or fall.
- Sizes: 75 x 75 x 30 mm.
- Weight: 25 grams.

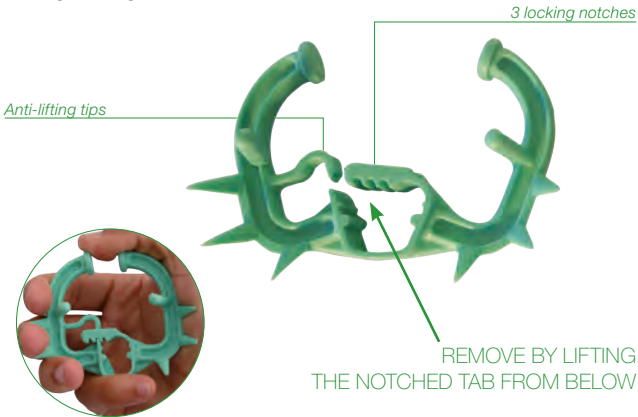

CLOSED MILK SUCKING PREVENTOR

Code	Model	O/pack.
220500	Plastic milk sucking preventor x 4	-
227038	Plastic milk sucking preventor in bulk (minimum 100 units)	x 600



■ ALUMINIUM MILK SUCKING PREVENTOR

Adjustable aluminium milk sucking preventor. Professional model.



Code	Model
227052	Aluminium milk sucking preventor

■ CLAMPEX

Disposable umbilical clamp for calves. Usable length: 45 mm.

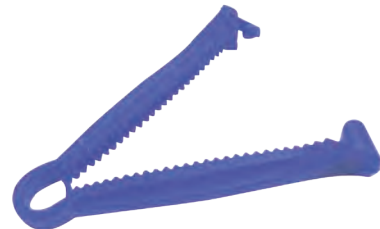

Code x 50	Model
157590	Clampex

BOTTLE TEATS

Non-perforated, natural latex teats that fit on bottle necks.
Certified 93/11/CE.

Supplied in bulk.

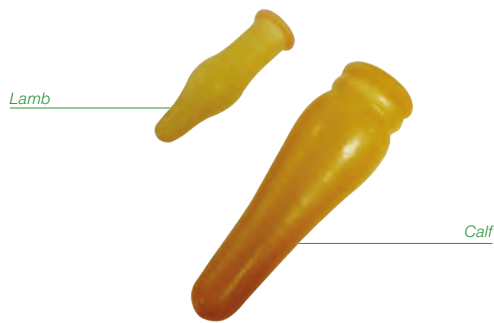

Code	Model	O/pack.
227023	Lamb	x 1000
227024	Calf	x 500

TEAT CATHETERS

2.5 mm diameter stainless steel teat catheters with Luer-Lock hub.

- Ball tips with 2 deburred side holes.

Supplied in plastic bags by 12.



Code x 12	Total Length	Cannula length
227061	80 mm	60 mm
227066	100 mm	80 mm
227071	120 mm	100 mm

DANISH TEAT SLITTER

Stainless steel Danish teat slitter with concealed, sharpened blades.



Code	Length
307984	19.5 cm

ADOPT-SPRAY

Adoption spray, consisting of a special blend of fragrances to disguise odors and promote:

- care of lambs and calves by their mothers
- grouping for transportation or mixing groups (grazers, heifers)
- acceptance of new food on weaning (piglet).

Supplied in boxes of 12.



Code x 12	Model
227500	200 mL aerosol spray

SAW WIRE

Dehorning and embryotomy wire.

Supplied on a plastic reel.



	Code	Model	Length	Diameter	O/pack.
A	220840	Swedish 27 strand	12 m	1.4 mm	-
B	227842	Standard 18 strand	12 m	1.7 mm	x 200

SAW WIRE HANDLE

Saw wire handle.

Supplied in pairs.

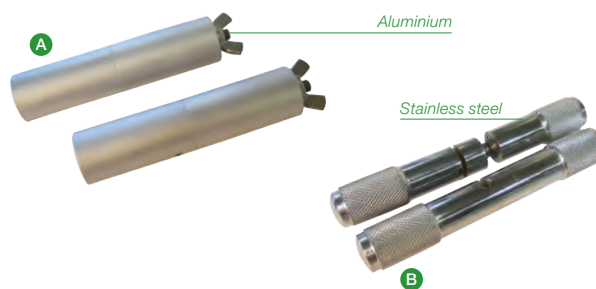

	Code	Model	Diameter	Length
A	223100	Strong, aluminium	24 mm	100 mm
B	227840	Thin, stainless steel	12/15 mm	103 mm

SH PLUS

Dehorning gel.

- For young calves (between 8 and 21 days old) from the moment the horn buds can be felt.
- Dehorn by applying a single drop on the horn buds.
- The least traumatic horn removal method for the animal.
- One applicator containing 45 grams can be used to dehorn about 30 calves.



	Code	Model
	227844	45g applicator with spatula

Outer packaging:
box of 24 units



DIGIFLASH

Digital thermometer for small and large animals.

- **Flexible** tip, length 7 cm.
- Temperature measurement in **5 seconds**.
 - Recalls the last 5 values.
 - Temperature range: 32 to 43 °C / 90 to 110 °F.
 - Accuracy: 0.1 °C / 0.18 °F.
 - Alarm at end of measurement.
- Low battery symbol display.
- Auto power-off.
- Waterproof.
- Shock-resistant.

Supplied in a transparent polycarbonate box with an additional battery.



FLEXIBLE TIP | FAST READING | 5 SECONDS

Code	Length	Tip length
227972	15.5 cm	7 cm

Outer packaging:
master case of 12 and 240 units

DIGIFIX

Digital thermometer for small and large animals.

- **Rigid** tip, length 7.5 cm.
- Temperature measurement in **10 seconds**.
 - Recalls the last 5 values.
 - Temperature range: 32 to 43°C/90 to 110°F.
 - Accuracy 0.1°C/0.18°F.
 - Alarm at end of measurement.
- Low battery symbol display.
- Auto power-off.
- Waterproof.
- Shock-resistant.

Supplied in a transparent polycarbonate box with an additional battery.



RIGID TIP

Code	Length	Tip length
227978	15.5 cm	7.5 cm

Outer packaging:
master case of 12 and 240 units

ZOOMETRIC MEASURING TAPE

Measuring tape for cattle and pigs to measure and estimate the standing weight of slaughtered cattle and pigs.

- With or without automatic roller.



Code	Model	Length	O/pack.
227081	Without automatic roller	2.5 m	-
227082	With automatic roller	2.5 m	x 350



VAGINOSCOPE

Electric vaginoscope with plexiglas speculum.

- Compact and solid handle made from anodised aluminium. **D**
- Plexiglas speculum that slides through the handle ring. **A**
- Lock the speculum with the handle. **D**
- Usable in all positions.
- Magnified light bulb sends beam of light to the end of the speculum.
- Replaceable penlight. **C**
- Can be entirely disassembled. Resistant to boiling.

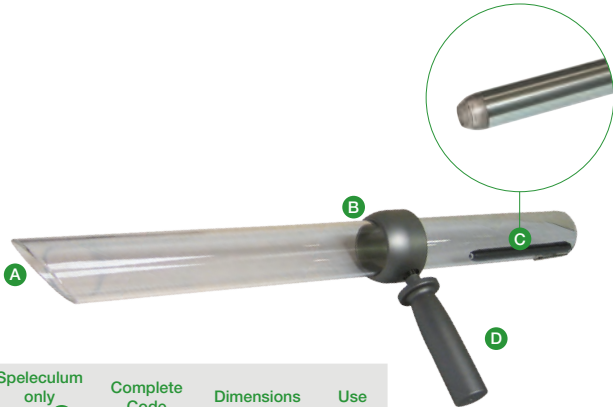

Speeculum only Code A	Complete Code	Dimensions	Use
223007	223013	2 x 30,5 cm	Goat
223002	223000	4 x 49,5 cm	Cow
223008	223010	5 x 54,5 cm	Mare

ACCESSORIES

	Code	Model	Use
C	223001	Lamp	-
D	223004	Handle only	-
B	223005	Handle ring	Cow
B	223011	Handle ring	Mare
B	223012	Handle ring	Goat/Ewe

COLOSTRUM SCALE

To evaluate the quality of the maternal colostrum absorbed by the new-born calf.

The floating level of the densimeter estimates the quantity of gammaglobulins in the maternal colostrum.

- Colour-coded for quality assessment at a glance:
 - Green zone: ≥ 100 g/l.
 - Yellow zone: 50-100 g/l.
 - Red zone: ≤ 50 g/l.
- Minimum value: 25 g/l.
- Maximum value: 125 g/l.

	Code	Model
A	227300	Densimeter only (with plastic box)
B	227304	Colostrum scale + separate test-tube
C	227302	Colostrum scale + integrated test-tube

SPECULUM EWES

NEW

Stainless steel speculum for ewes.

- Two articulated blades in stainless steel.
- Upper blade: 17.5 cm.
- Lower blade: 15 cm.



Code	Model
307926	Speculum ewes



EQUINE DENTAL FORCEPS

Stainless steel equine dental forceps for molars.



	Code	Model	Length
A	307900	Upper tooth, curved	370 mm
B	307901	Lower tooth, straight	370 mm

WOLF TOOTH EXTRACTION FORCEPS

Stainless steel equine dental forceps for wolf tooth extraction.



	Code	Model	Length
B	307902	Half-Curved	260 mm
A	307903	Curved	260 mm

TOOTH RASPS

Tooth floats for horses, with wooden handles.

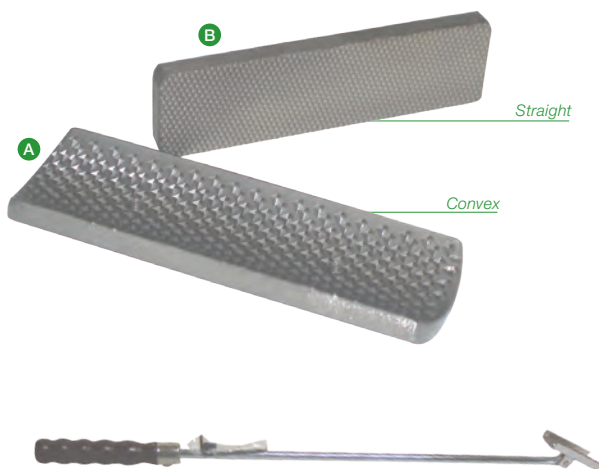

	Code	Model
	307904	Complete: Convex
	307905	Complete: Straight
A	307907	Convex blade only
B	307908	Straight blade only

MOUTH GAGS

Stainless steel equine mouth gag. Climax and Schoupe (spring) models.



	Code	Model	Length	Opening
	227032	Schoupe	260 mm	-
	227033	Climax	-	145 x 155 mm



RUMEN TROCARS

Stainless steel rumen trocars.

- Plastic handle.
- Cannula with two holes on the flange for fixation.

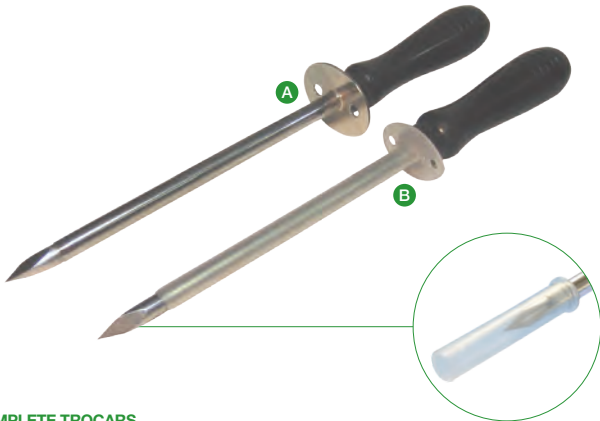

COMPLETE TROCARS

Stainless steel cannulas code	Plastic disposable cannulas code	Diameter	
		Int.	Ext.
220300	220330	5 mm	6 mm
220305	220335	8 mm	9 mm
220310	220340	9 mm	10 mm
220315	-	11 mm	12 mm

SPARE PARTS

Stainless steel cannulas code	Plastic disposable cannulas code	Diameter		Cannula length
		Int.	Ext.	
220400	220450	5 mm	6 mm	112 mm
220405	220455	8 mm	9 mm	142 mm
220410	220460	9 mm	10 mm	162 mm
220415	-	11 mm	12 mm	190 mm

SCREW TROCAR

Plastic screw trocar.

- Food grade, with 2 holes on the flange for fixation.
- Trocar designed for chronic bloat.
- Can be left in place for several days, or even longer if correctly inserted.
- Peritoneum and rumen are held together, minimising the risk of peritonitis.

Supplied in a polyethylene bag with instructions for use.

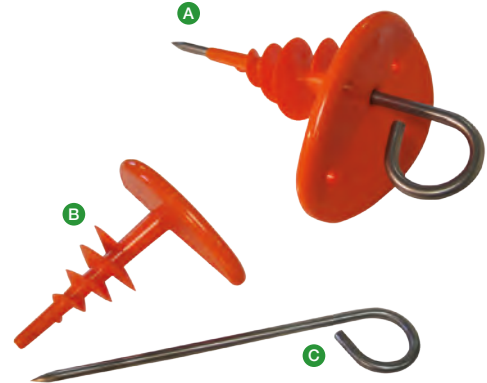

	Code	Model
A	220600	Complete trocar with instructions
B	220602	Trocar only
C	227800	Stainless steel stylet only

BLOODLETTING TROCAR

Stainless steel bloodletting trocar with screw-on handle.



Code	Diameter		Total length	Cannula length
	Int.	Ext.		
220291	5 mm	6 mm	250 mm	90 mm

■ STOMAFLEX

Orange silicone nasoesophageal tubes for horses and cattle.

- One round, open end with a side hole.
- Flexible, atraumatic and non-deformable.

Supplied in a polyethylene bag.

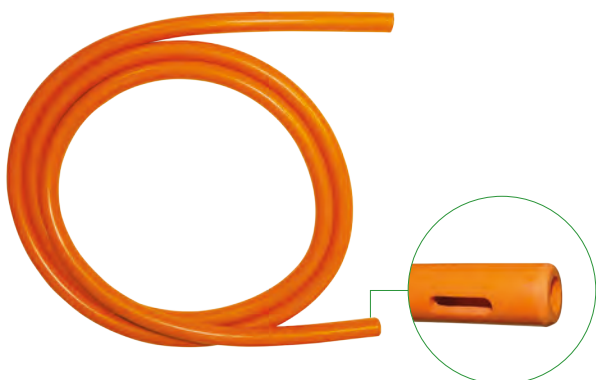

Code	Diameter		Length
	Int.	Ext.	
227013	6 mm	9.5 mm	2 m
227005	8 mm	13 mm	2 m
227010	9.5 mm	16 mm	2.25 m
227014	11.6 mm	19 mm	3 m

■ NASOFLEX

Transparent PVC nasoesophageal tubes for horses.

- One round, open end with a side hole.
- One end widened for pump or funnel.
- Good flexibility during both summer and winter, atraumatic and non-deformable.
- Easy to insert and clean.

Supplied in a polyethylene bag.

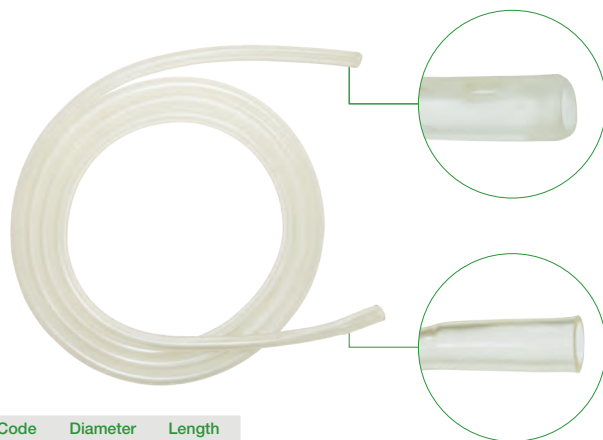

Code	Diameter	Length
222000	9 mm	2.6 m
222002	13 mm	2.7 m
222004	16 mm	3.4 m
222006	18 mm	3.6 m

■ NASOFLEX PUMPS

Plastic or metal pumps with tube adapter for Nasoflex tubes. Inexpensive and sturdy.

- Plastic pump: 0.5 L flow.
- Metal pump: 0.125 L flow.



Metal pump

Plastic pump

Code	Model
222020	Plastic pump + tube adapter
227020	Metal pump + tube adapter

■ ESOFLEX

Metal oesophageal probes, coated in red plastic, for cattle and calves.

- Open, rounded metal tip with side eyelets **A**.
- Plastic rod to aid unblocking and cleaning of the probe **B**.
- Easy to clean.
- Bite-resistant.

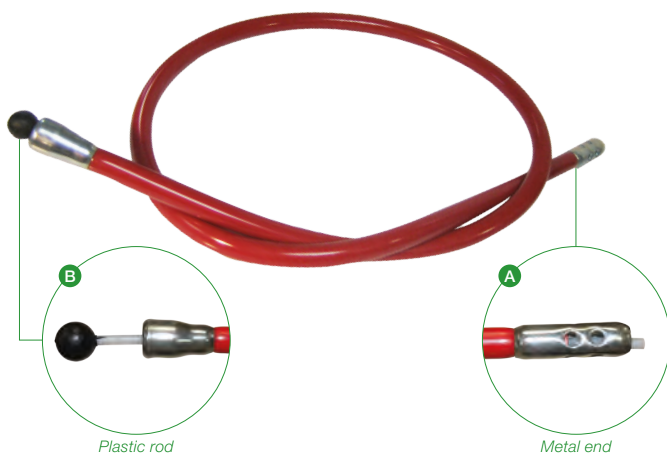

Plastic rod

Metal end

Code	Ext. diameter	Use	Length
227015	14 mm	Calf	1.35 m
227016	18 mm	Adult	1.60 m



GÉNIA BOLUS APPLICATOR - DESCRIPTION

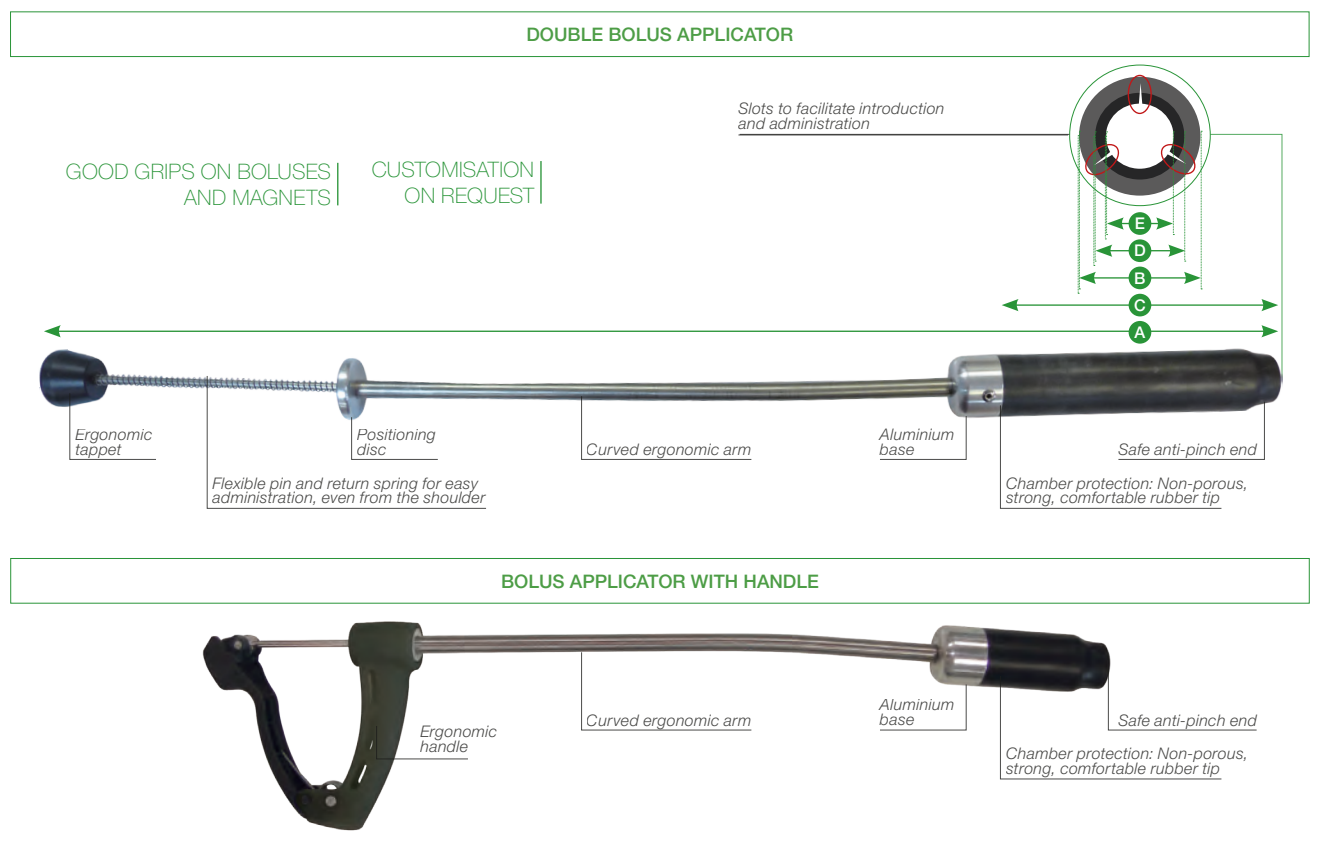

BOLUS APPLICATOR

Ergonomic bolus applicator in stainless steel (stainless steel or aluminium barrel; stainless steel arm, pin and spring) for the administration of a bolus or magnet to cattle.

- Any type of bolus or magnet can be administered.
- Adaptable to your needs.
- Protected barrel: strong, flexible and non-porous rubber tip.
- No pinching or injury.
- Ergonomic curved arm.
- Retains the bolus before administration; minimal effort to administer.
- Flexible stainless steel spring for easy administration, even from the shoulder.

Special order: other sizes, with a minimum order of 50 units.

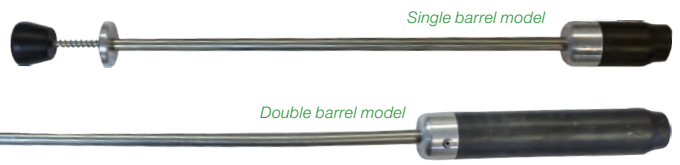

OTHER LENGTHS | ON DEMAND

Code	A Total length	B Diameter maxi ext. barrel	C *Barrel length	D Diameter int. barrel	E Tip int.
215090	370 mm	27 mm	50 mm	17,5 mm	12 mm
215120	400 mm	30 mm	65 mm	22 mm	18 mm
215060	570 mm	39 mm	65 mm	29 mm	24 mm
215080	620 mm	39 mm	90 mm	29 mm	24 mm
215100	650 mm	29 mm	105 to 110 mm	20 mm	12 mm
215160	680 mm	45 mm	105 to 120 mm	35,6 mm	24 mm
215150	680 mm	45 mm	110 mm	35,6 mm	30 mm
215030	680 mm	52 mm	120 mm	40,5 mm	28 mm
215070	750 mm	52 mm	120 mm	40,5 mm	28 mm
215140	720 mm	30 mm	140 mm	22 mm	18 mm
215130	750 mm	43 mm	150 mm	35,6 mm	22 mm
215000	800 mm	40 mm	180 mm	29 mm	22 mm
215040	880 mm	52 mm	220 mm	40,5 mm	28 mm

*Distance from piston to tip outlet. Classification according to (C).

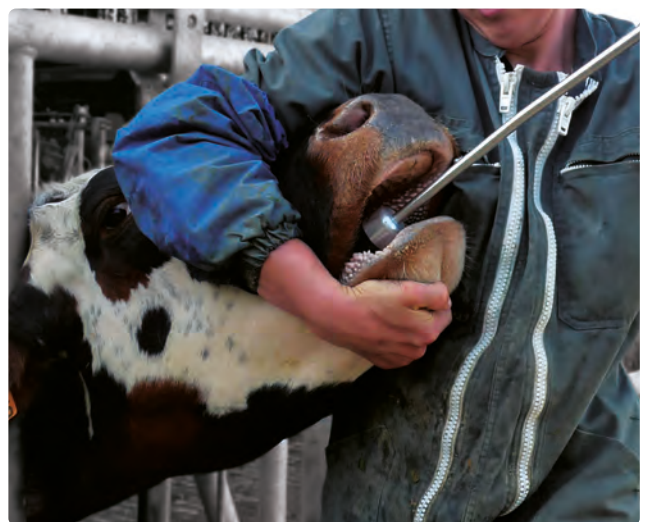

BOLUS APPLICATOR WITH HANDLE

- Identical to standard bolus applicator.
- Ergonomic handle.
- Articulated handle end to ease manipulation.

OTHER LENGTHS |
ON DEMAND

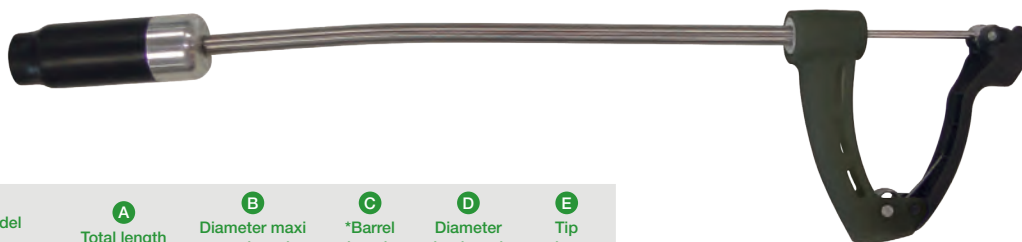

Code	Model	A Total length	B Diameter maxi ext. barrel	C *Barrel length	D Diameter int. barrel	E Tip int.
215180	Cattle, sheep	610 mm	39 mm	90 mm	29 mm	24 mm
215192	Cattle	710 mm	45 mm	90 mm	35,6 mm	29 mm
215195	Sheep	300 mm	26 mm	50 mm	17,5 mm	14 mm

*Distance from piston to tip outlet.

BOVIMAG® CATTLE MAGNETS

Powerful rectangular magnets made of oxyferite.

- Dimensions: 60 x 20 x 15 mm
- Supplied by 6 or 12.

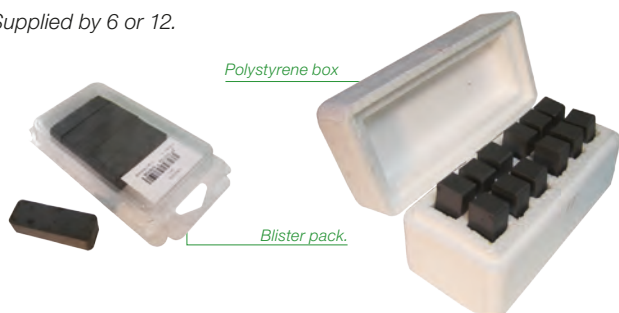

Code	Packaging	Pack.	O/pack.
227812	Polystyrene box	x 12	x 16
257810	Blister	x 6	-



ACCESSORIES

Code	Model
215060	Bolus applicator for cattle magnets

BOVIMAG® CAGE MAGNETS

Uniquely designed cage magnet collects longer and more numerous metallic objects, which align themselves longitudinally.

- Single piece magnet 36 mm in diameter and 100 mm long avoids the overlapping of magnets in the rumen.
 - Bars of the cage situated on the 4 edges of the magnet create more space for foreign bodies.
 - Spaced out lines allow foreign bodies to align along the magnet.
- Supplied in boxes of 12.

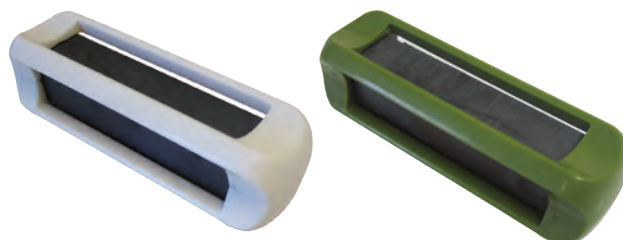

Code x 12	Model
227815	Green
227817	White

ECOMAG

Cage magnet with double magnet and multi-retaining bars.

Supplied in boxes of 12.

Code x 12	Model
227820	Green

Outer packaging:
master case of 10

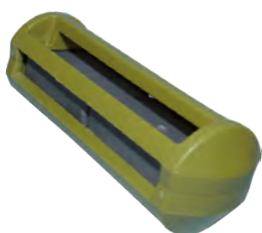

CAGE MAGNET APPLICATOR

Cage magnet applicator for BOVIMAG® and ECOMAG cage magnets.

- Magnet is held by the rubber sleeve.



Code	Model
215030	Cage magnet applicator



■ SURGIFAR RAZOR BLADE

Hoof knives with very narrow stainless steel surgical blades, farrier quality.

- Standard handle in stained and polished beech.
- Riveted half-blades in cutlery steel.
- Slightly curved blades with short, narrow grooves.
- Sharp along whole length to the handle.

Supplied in a plastic case.

On demand: bevelled blade.



A SURGIFAR SINGLE BLADE

Code	Model
220140	Right-handed surgical blade
220142	Left-handed surgical blade
220148	Right-handed large blade
220149	Left-handed large blade

B SURGIFAR DOUBLE BLADE

Code	Model
220151	Right-handed large blade with double-edged (1 short and 1 long)

■ FARLAND RAZOR BLADE

Carbon steel hoof knives, farrier quality.

- Long, **tapered**, ergonomic, stained and polished beech handle.
- Riveted half blades made of cutlery steel.
- Straight blades, wide at the base and narrow at the end.
- Slight curve.
- Short and narrow grooves.

Supplied in a plastic case.

On demand: bevelled blade.



L: SHORT BLADE
XL: LONG BLADE

Code L	Code XL	Model
220120	220100	Right-handed
220122	220102	Left-handed

■ FARKNIFE RAZOR BLADE

Carbon steel hoof knives, farrier quality.

- Long, **thick**, ergonomic, stained and polished beech handle.
- Riveted half blades made of cutlery steel.
- Straight blades, wide at the base and narrow at the end.
- Slight curve.
- Short and narrow grooves.

Supplied in a plastic case.

On demand: bevelled blade.



Code L	Code XL	Model
220108	220134	Right-handed
220107	220136	Left-handed

■ FARLOOP

Carbon steel hoof knife, oval shape, farrier quality.

- Ergonomic, long tapered Farland handle made of polished, stained beech.
- Riveted blades made of cutlery steel.

Supplied in a plastic case.



Code	Model
220110	Large
220112	Small

VETLAND BEVELLED BLADE

Hoof knives with carbon steel blades, veterinary quality.

- Full blades riveted to a plastic handle.
- Slightly curved blades and standard grooves.
- Special cutlery steel.

Supplied in a plastic case.



	Code	Model	Finish
A	220002	Right-handed narrow blade	Single edge
	220004	Right-handed large blade	Single edge
	220006	Left-handed narrow blade	Single edge
	220008	Left-handed large blade	Single edge
B	220010	Right-handed large blade	Double edge (1 short and 1 long)
	220032	Right-handed large blade	Double edge (2 long)

STANLAND BEVELLED BLADE

Hoof knives with carbon steel blades, veterinary quality.

- Half-blades riveted to a beech handle.
- Slightly curved blades and standard grooves.
- Special cutlery steel.

Supplied in a plastic case.



	Code	Model	Finish
	220050	Right-handed large blade	Single edge
A	220052	Left-handed large blade	Single edge
B	220054	Right-handed large blade	Double edge (1 short and 1 long)

PROLAND BEVELLED BLADE

Hoof knives with stainless steel blades, veterinary quality.

- Half-blades riveted to a stained beech handle.
- Slightly curved blades and standard grooves.
- Special cutlery steel.

Supplied in a plastic case.



	Code	Model	Finish
A	220020	Right-handed narrow blade	Single edge
	220022	Right-handed large blade	Single edge
	220024	Left-handed narrow blade	Single edge
	220026	Left-handed large blade	Single edge
B	220030	Left-handed large blade	Double edge (1 short and 1 long)

DRAWING KNIVES BEVELLED BLADE

Double edge drawing knives with carbon steel blade, veterinary quality.

- Full blades riveted to a plastic handle.
- Special cutlery steel.

Supplied in a plastic case.



Code	Model	Size
220164	N°6	170 mm
220166	N°8	170 mm
220168	N°10	170 mm

p.156 [Find our sharpening steel](#)

SAGE KNIFE BEVELLED BLADE

Double edge carbon steel sage knife, veterinary quality.

- Full blade riveted to a plastic handle.
- Special cutlery steel.

Supplied in a plastic case.



Code	Length
220150	190 mm

RINGLAND

Ring shaped drawing knife with wooden handle for cattle and horses.

- Standard quality.
- Carbon-steel blade.



Code	Length	Model
227051	150 mm	Sharpened
227050	150 mm	Unsharpened



HOOFLAND

Sharpened hoof scraper made of special carbon steel of farrier quality.

- Wooden or plastic-reinforced handle.
- Cutlery steel for easy and long lasting sharpening.
- Easy to hold (plastic handle).

Supplied in a plastic case.

WOOD HANDLE

Code	Model	Total length	Blade length
220226	Medium	300 mm	32 mm

PLASTIC COATED HANDLE

Code	Model	Total length	Blade length
220202	Small	280 mm	27 mm
220213	Medium	280 mm	32 mm
220214	Large	360 mm	44 mm

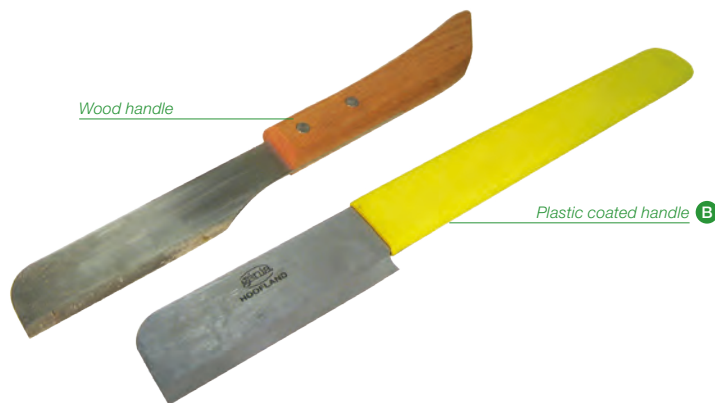

HOOFSCRAP

Sharpened hoof scraper with no grip. Standard quality.

Supplied in a plastic case.



Code	Model	Length
A 220200	Hoofscrap only	30 cm
220210	Hoofscrap only	24 cm
B 220199	PVC grip only	-

HOOF TESTERS

Stainless steel hoof testing forceps.



Code	Model	Length
227100	Flat	35 cm
227102	Flat	47 cm
227103	Round	35 cm
227104	Round	47 cm

SHARPENING STEEL

Oval sharpening steel, coated with diamond microparticles for finishing work.

- Suitable for all knives, especially the grooves of hoof knives and drawing knives.
- Total length 265 mm.

Supplied complete.



Code	Blade length	Blade width	Blade thickness
227222	150 mm	18 mm	5 mm

SHARPENING SET

Sharpening kit for hoof knives and hoof scrapers.

- Semi-circular whetstone to sharpen grooves.
- Conical whetstone for drills and turbines.

Supplied in a polyethylene bag with instructions for use.



Code	Model
220220	Complete set

CICABOM

Black balm ointment for fast wound healing.

- Its antiseptic, bactericidal, and insecticidal qualities provide an effective barrier for the wound and keep the area moist.
- Composition: vaseline, cod liver oil, pharmaceutical-grade zinc oxide, balsam of Peru, pine tar.



Code	Model
227846	200 mL jar
227847	500 mL jar



GROOMING

Grooming scissors 158

TISSERAND STANDARD SCISSORS

Straight carbon steel grooming scissors, without finger rest, including:

- Adjusting knob.
- Blade with micro teeth.
- Round rings.



Code	Model	Length
500262/1	Straight gold bronze	15,5 cm
500296/1	Curved bronze	17 cm

TISSERAND THINNING SCISSORS

Carbon steel grooming scissors including:

- Adjusting knob.
- Finger rest.
- Standard rings.
- Teeth on both blades.



Code	Model	Length	Teeth
500094	Adjustable straight bronze	15,5 cm	23
500095	Adjustable straight gold bronze	15,5 cm	23

TISSERAND SCULPTING SCISSORS

Carbon steel grooming scissors including:

- Adjusting knob.
- Finger rest.
- Standard round rings.
- Teeth on one blade.



Code	Model	Length	Teeth
500126	Adjustable straight gold bronze	15,5 cm	30
500165	Adjustable straight bronze	15,5 cm	40

GENIA STAINLESS STEEL SCISSORS

Stainless steel grooming scissors including:

- Adjusting knob.
- Round rings.
- Micro-teeth blade.
- Possibility to add a finger rest.

Supplied without finger rest.

Minimum quantity: 10 units per model.



Code	Model	Length
505302/1	Curved	18,5 cm
505271/1	Straight	18,5 cm
505307/1	Curved	20 cm

ACCESSORIES

Code	Model
A 599110	Finger rest

THINNING SCISSORS WITH SCREW

Chrome-plated carbon steel thinning scissors.



Code	Model	Length
601475	With screw, straight	17 cm
601476	With screw, curved	17 cm



■ ALPHABETICAL

A

ABOMASUM, DISPLACED	55
ABS, CASE	119
ABSORBABLE, SUTURE	38-39
ABSORBENT, DRYSOFT® PAD	76
ACCESSORY, ALL PROJECTOR	98
ACCESSORY, DRENCHING	138-139
ACCESSORY, GAS PROJECTOR	94-95
ACCESSORY, HOOF CARE	156
ACCESSORY, HOSPITALIZATION	84-85
ACCESSORY, NEEDLE	23
ACCESSORY, OSTÉOSYNTHESIS	65-66
ACCESSORY, SYRINGE, INJECTION	17
ACCESSORY, SYRINGE, PROJECTOR	104
ADAPTER, HYPODERMIC SYRINGE	16
ADERPLAST®, ADHESIVE BANDAGE	78
ADERPLAST® ULTRA, ADHESIVE BANDAGE	78
ADHESIVE, ADERPLAST® BANDAGE	78
ADOPTION SPRAY	145
ADOPT-SPRAY, ADOPTION SPRAY	145
ADSON BROWN FORCEPS	50
ADSON FORCEPS	50
ADSON GRAEFE FORCEPS	50
ADVANCE, ELECTRIC POD	140
AEROSOL, ADOPTION	145
AFRICAN CANNULA, SYRINGE, PROJECTOR	103
AGRIPLAST, DRENCHING SYRINGE	137
AIR NEEDLE	23
AISOGAN®, EXPLORATION GLOVE	123
ALGI, ANIPLAST® DRESSING	81
ALGINATE CALCIUM DRESSING	82
ALKAZYME, DISINFECTION, CLEANSING	132
ALLIS FORCEPS	51
ALU-DETECT®, DETECTABLE NEEDLE	22
ALUMINIUM, NEEDLE, HUB	20
ALUMINIUM SYRINGE, PROJECTOR	102
ANESTHESIA, INTUBATION CATHETER	36
ANIPLAST® DRESSING, ALGI	81
ANIPLAST® DRESSING, HYDRO	81
ANIPLAST® DRESSING, SPONGI	81
ANIPLAST® DRESSING, SURGI	81
ANIPLAST® DRESSING, TULLO	81
ANIPLAST® SET, DRESSING	80
ANIVEN®, CATHETER	25
APPLICATOR, BOLUS	152-153
APPLICATOR, DRENCHING	134-137
APPLICATOR, MAGNET	152-153
APPLICATOR, PILL	85
APPLIMASTER®, POUR-ON DRENCHING GUN	134
ARMPIT PROTECTION, GLOVE	123
ASPIRATION CANNULA	53
ASSEMBLY, GÉNIAMATIC, VALVE	16
AUTOMATIC, INJECTION STICK	106
AUTOMATIC, SYRINGE	12-13

B

BALLOON, INTUBATION, CATHETER	36
BALM, CICABOM, OINTMENT	156
BAND, LEG	141
BANDAGE	77-79
BANDAGE, ADHESIVE, ADERPLAST®	78
BANDAGE, COHÉSIVE FUN STRAP®	77
BANDAGE, COHÉSIVE STRAP BAND	77
BANDAGE, ELASTIC	77-78
BANDAGE, EQUINE, EQUIPLAST®	78
BANDAGES, ADERPLAST®	78
BANDAGES SCISSORS	48
BARB, 11 MM SYRINGE CANNULA, PROJECTOR	101
BARB, 13 MM SYRINGE CANNULA, PROJECTOR	103
BARREL, ANODISED ALUMINIUM, SYRINGE, PROJECTOR	102
BARREL, DRENCHING GUN	138

BARREL, PROJECTOR	95
BEARING RETAINER	56
BETANETT, READY TO USE STAIN REMOVER	132
BEVELLED BLADE, SAGE KNIFE	155
BIONET, CLEANSING POWDER	132
BIRD OF PREY, PROTECTIVE GLOVE	120
BIRD, SYRINGE	9, 12-13
BLADDER, CATHETER	35
BLADE, NECROPSY KNIFE	53
BLADE, TOOTH RASPS	149
BLADES, SWANN MORTON SCALPEL	44
BLEEDING, TROCAR	150
BLOAT	150-153
BLOODLETTING	150
BLOWPIPE	89
BLOWPIPE, DISTINJECT, 16 MM, EXTENSION	89
BLOWPIPE, MINI-JECT, 11 MM	89
BODY, PROTECTION	125-126
BOLUS APPLICATOR, HANDLE	153
BOLUS APPLICATOR, MAGNET	152-153
BONE PIN CHUCK	66
BONNEY, SUTURE NEEDLE	43
BOOT, DISPOSABLE PROTECTION, POLYBOOT	126
BOTTLE HANGER, AUTOMATIC SYRINGE	12-13
BOUFFANT CAP	126
BOVIMAG®, CAGE MAGNET	153
BOVIMAG®, CATTLE MAGNET	153
BOYTON, NEEDLE HOLDER	49
BRAKE, SYRINGE CANNULA, PROJECTOR	103
BREAKER, TABS	85
BROPHY SCISSORS	46
BROWN, ADSON FORCEPS	50
BRUSH, SURGICAL	130
BÜHNER NEEDLE	56
BÜHNER, VAGINAL TAPE	56
BULL LEAD	140
BURDIZZO, CASTRATOR	142
BUTTON, SURGICAL	66

C

CAESAREAN FORCEPS	56
CAESAREAN, PROLAPSE PREVENTION	56
CALCIUM, ALGINATE DRESSING	82
CALF PULLER, GÉNIA	143
CALVE, INFUSION SET, PERFUVET® SOLO	31
CALVING	143-144
CALVING, PROTECTIVE COVERALL	126
CANCELLOUS SCREW, BONES	62
CANIS-MOBILE®, MOBILITY CART	68
CANNULA, 11 MM SYRINGE, PROJECTOR	101
CANNULA, 13 MM SYRINGE, PROJECTOR	103
CANNULA, AFRICAN, SYRINGE, PROJECTOR	103
CANNULA, ASPIRATION	53
CANNULA, BARB, 13 MM SYRINGE, PROJECTOR	103
CANNULA, BRAKE, SYRINGE, PROJECTOR	103
CANNULA, ELEPHANT, SYRINGE, PROJECTOR	103
CANNULA, FLANGE, 13 MM SYRINGE, PROJECTOR	103
CANNULA, PRACTICE, 11 MM SYRINGE, PROJECTOR	101
CANNULA, PRACTICE, 13 MM SYRINGE, PROJECTOR	103
CANNULA, SMOOTH, 11 MM SYRINGE, PROJECTOR	101
CANNULA, SMOOTH, 13 MM SYRINGE, PROJECTOR	103
CANNULA WITH BARB, 11 MM SYRINGE, PROJECTOR	101
CANNULA WITH FLANGE, 11 MM SYRINGE, PROJECTOR	101
CAP, MALE	33
CAPSULE, CO ₂ , PROJECTOR	94
CAPSULE HOLDER, CO ₂ , PROJECTOR	97
CAPSULES, INJECTION, SYRINGE, PROJECTOR	102
CAPTURE	87-120
CAPTURE, CAT	110, 112, 114-115
CAPTURE, REPTILE	117-119
CARE, FOOT	154-156
CARE, LACTATION	145
CARTRIDGE, EJECTOR, PROJECTOR	97

CASE, ABS, REPTILE CAPTURE SET	119
CASTRATION	142
CAT, CAPTURE TONG	115
CAT, CONTENTION KENNEL	112
CAT, PROTECTIVE GLOVE	120
CAT, TRAP	110
CAT, URINARY CATHETER, UROLENE® CAT	34
CATCHER, HOG	140
CATHETER	25-26
CATHETER ANIVEN®	25
CATHETER, BLADDER AND UTERINE, STAINLESS STEEL	35
CATHETER, INTRAFLO	26
CATHETER, INTRANULE	26
CATHETER, INTUBATION WITH BALLOON	36
CATHETER, LACRIMAL	36
CATHETER, TEAT	145
CATHETER, URINARY, POLYPROPYLENE	35
CATHETER, URINARY TUBING	36
CATHETER, URINARY, UROLENE® CAT	34
CATHETER, URINARY, UROLENE® DOG	34
CATHETER, UROLENE®	34
CATHETER, UROLITHIASIS	36
C-CUT, HYSTERECTOMY	56
CHERON, FORCEPS	143
CHUCK, BONE PIN	66
CHUCK KEY	66
CICABOM, HOOF OINTMENT	156
CLAMP, RIGHT ANGLE	51
CLAMP, UMBILICAL, CLAMPEX	144
CLAMPEX, UMBILICAL CLAMP	144
CLAMPS, FIXATION	61
CLEAN, GÉNIA, HYGIENE RANGE, DISINFECTION	128-129
CLEANING, SET, PROJECTOR	97
CLEANSING, DISINFECTION	128-132
CLEANSING GENTLE LOTION, GÉNIA CLEAN	130
CLEANSING, HAND	130
CLEANSING POWDER, GÉNIA CLEAN	128
CLIMAX, MOUTH GAGS	149
CLOSED, URINARY CATHETER UROLENE®	34
CLOTHING, PROTECTION	125-126
CO ₂ CAPS, PROJECTOR	94
COHESIVE, FUN STRAP® BANDAGE	77
COHESIVE, STRAP BAND BANDAGE	77
COLLAR, ELIZABETHAN	70-73
COLOSTRUM SCALE	148
COMBIVET, PROTECTION	126
CONTAINER, WASTLE	23
CORTICAL SCREW, OSTEOSYNTHESIS	62
COSYPAD® EXAMINATION PAD, HOSPITALIZATION	74-75
COSYPAD®, HANGER	70
COVERALL, DISPOSABLE, PROTECTION, COMBIVET	126
COVERALL PROTECTIVE CALVING	126
COW LIFT	140
CRILE FORCEPS	51
CRILE WOOD, NEEDLE HOLDER	49
CROWN, SCISSORS	65
CRUSHING, CUPS, TABLET	85
CUPS, TABLET CRUSHING	85
CURAFIL, HYDROGEL DRESSING	82
CURSOR SYRINGE	8-10
CUTTABLE PLATES, OSTEOSYNTHESIS	63
CUTTING, WIRE, SCISSORS	65

D

DANISH TEAT SLITTER	145
DCP, PLATE, OSTEOSYNTHESIS	64
DEBAKEY FORCEPS	50
DEHORNING	146
DELTA, 11 MM PNEUMATIC PROJECTOR	90
DELVO, NOZZLE	18
DENSIMETER, COLOSTRUM SCALE	148
DENTAL FORCEPS, HORSE	149
DENTAL FORCEPS, WOLF TOOTH, HORSE	149

DENTISTRY, EQUINE	149	ENUCLEATION SCISSORS	47	FOREIGN BODY, FORCEPS	52
DERMASTEEL, NOZZLE	19	EQUINE DENTISTRY	149	FUN STRAP®, COHESIVE BANDAGE	77
DETECTABLE, ALU-DETECT® NEEDLE	22	EQUINE, EQUIPLAST® BANDAGE	78	FUNCOL®, E-COLLAR	71
DETECTABLE, DISPOSABLE HYPODERMIC NEEDLE	22	EQUIPLAST®, EQUINE BANDAGE	78	FUR AND MANE SCISSORS	48
DETECTABLE, PLASTI-DETECT® NEEDLE	22	EQUIPMENT, PROTECTION, HOSPITALIZATION	74-76		
DETERGENT, CLEANSING, ALKAZYME	132	ESOFLEX, STOMACH TUBE	151	G	
DETERGENT, DISINFECTING SPRAY, GÉNIA CLEAN	129	EWE, SPECULUM	148	GARFLEX, TOURNIQUET	23
DETERGENT, POWDER, BIONET	132	EXAMED, EXAMINATION GLOVE, LATEX	124	GAS, LIGHTER REFILL	104
DIAGNOSTIC, INSTRUMENT, MEASURE	147-148	EXAMINATION, GLOVE	124	GAS, PROJECTOR	92-93
DIGIFIX, THERMOMETER	86, 147	EXERCICE, CANNULA, 11 MM SYRINGE, PROJECTOR	101	GAS REMOVER, PLUNGER PUSHER	104
DIGIFLASH, THERMOMETER	86, 147	EXERCICE, CANNULA, 13 MM SYRINGE, PROJECTOR	103	GEASE, SILICONE, SILIGLISS	17, 104
DIGIVET, THERMOMETER	86	EXPLOGAN®, EXPLORATION GLOVE	122	GEL, DEHORNING, SH PLUS	146
DISINFECTANT, CLEANSING SPRAY, GÉNIA CLEAN	129	EXPLOGEL®, LUBRICATING GEL	125	GEL, ECHOGRAPHY, EKOGE	125
DISINFECTANT, FOAMING SPRAY, GÉNIA CLEAN	129	EXPLORATION, LARGE ANIMAL, GEL	125	GEL, EXAMINATION GLOVE	125
DISINFECTION, FLOOR, GÉNIA CLEAN	129	EXPLORATION, LARGE ANIMAL, GLOVE	122-123	GEL, HAND SANITISER, GÉNIA CLEAN	130
DISINFECTION PROTOCOL, CLEANSING	128	EXPULSION, EXPLORATION GLOVE	122-123	GELPI RETRACTOR	52, 66
DISPENSER CASE, SUTURE	38-41	EXTENSION, INFUSION SET, PERFUVET® TWIST	30	GENALU, NEEDLE	20
DISPLACED ABOMASUM	55	EXTENSION, INJECTION STICK	17, 106	GÉNIA CLEAN, CLEANSING, DISINFECTION	128-130
DISPROJECT®, 2 PIECES SYRINGE	14	EXTENSION, STICK, INJECTION	17, 106	GÉNIAMATIC, LONG SYRINGE	9
DISPROJECT®, 3 PIECES SYRINGE	14	EXTERNAL FIXATION	59-61	GÉNIAMATIC, VALVE ASSEMBLY	16
DISPROJECT®, DISPOSABLE NEEDLE	21			GÉNIAMATIC WITH TUBING, SYRINGE	9
DISPROJECT®, SAFETY INSULIN SYRINGE	15	F		GÉNIAPLEX 300 ML, DRENCHING SYRINGE	136
DISPROJECT®, STANDARD INSULIN SYRINGE	15	FARKNIFE RAZOR BLADE, FARRIER KNIFE	154	GÉNIAPLEX 300 ML, HYPODERMIC SYRINGE	8
DISPOSABLE, 13 MM SYRINGE, PROJECTOR	105	FARLAND RAZOR BLADE, FARRIER KNIFE	154	GÉNIAPLEX, LONG SYRINGE	8
DISPOSABLE HYPODERMIC NEEDLE	20-22	FARLOOP, FARRIER KNIFE	154	GÉNIAPLEX, SYRINGE	8
DISPOSABLE, HYPODERMIC SYRINGE	14-15	FARRIER RANGE, HOOF KNIFE	154	GERLACH-BÜHNER, NEEDLE	56
DISPOSABLE PROTECTION, POLYBOOT	126	FARRIER, VETERINARY RANGE	155	GILLIES, NEEDLE HOLDER	49
DISPOSABLES, HOSPITALIZATION	70-82	FASTFIL®, ABSORBABLE SYNTHETIC SUTURE	38	GLOVE, ARMPIT PROTECTION	123
DISSECTION FORCEPS	50	FEATHERED, SYRINGE STABILISER, PROJECTOR	102	GLOVE, CAPTURE	120
DISTANCE, INJECTION STICK	17, 106	FEEDING, NOZZLE, TUBE	137	GLOVE, CAPTURE, HIGH REINFORCED	120
DISTANCE, SYRINGE	9-10, 12, 106	FEEDING SYRINGE, TUBE	137	GLOVE, CAPTURE, PROTECTION, CAT, DOG	120
DISTINJECT	87-120	FEEDING, TUBE	137	GLOVE, CAPTURE, PROTECTION, MONKEY, BIRD OF PREY	120
DISTINJECT, 11 MM BLOWPIPE, 16 MM	89	FILAMID, NON-ABSORBABLE SUTURE	40	GLOVE, EXAMINATION	124
DISTINJECT, POLE	107	FILESTER, NON-ABSORBABLE SUTURE	40	GLOVE, EXPLORATION, LARGE ANIMAL	122-123
DOG, PROTECTIVE GLOVE	120	FILINE, NON-ABSORBABLE SUTURE	40	GLOVE, INSEMINATION	122-123
DOG, TRAP	111	FILSILK, NON-ABSORBABLE SUTURE	40	GLOVE, SURGERY	124
DOG, URINARY CATHETER, UROLENE® DOG	34	FIXATION, EXTERNAL ROD	61	GLYCOFIL®, ABSORBABLE SYNTHETIC SUTURE	39
DORSAL TANK	33, 139	FLAMATIC®, SYRINGE	12	GOWN, MILKING, VELVET	126
DOSIPLEX, SYRINGE	10	FLANGE, 11 MM SYRINGE CANNULA, PROJECTOR	101	GOWN, PROTETIVE, CALVING	126
DOUBLE NEEDLE, TRANSFER	33	FLANGE, 13 MM SYRINGE CANNULA, PROJECTOR	103	GRADUATED, PRECISION REAR SIGHT	98
DRAPVET, DISPOSABLE SURGICAL DRAPE	54	FLAT SPLINT	79	GRAEFE, ADSON FORCEPS	50
DRAWING KNIFE BEVELLED BLADE	155	FLIP, SYRINGE, PROJECTOR	105	GRAEFE FORCEPS	50
DRENCHING	134-139	FLUIDOTHERAPY SET	33	GREASE, SILICONE	104
DRENCHING, ACCESSORY	138-139	FOAM, HYDROPHILIC, DRESSING	82	GREENCOL, E-COLLAR	71
DRENCHING GUN	134-135	FOLDING, KENNEL	113	GROOMING	157-158
DRENCHING, NOZZLE	17, 138	FOMON SCISSORS	47	GROOMING, SCISSORS	158
DRENCHING, SYRINGE	136-137	FORCE-FEEDING, AGRIPLAST 100 ML SYRINGE	137	GRYMER STERNER, DISPLACED ABOMASUM	55
DRENCHMASTER®, DRENCHING GUN	134	FORCE-FEEDING NOZZLE	137	GUN, DRENCHING	134-135
DRESSING	80-82	FORCEPS, ADSON	50		
DRESSING, ABSORBENT	81-82	FORCEPS, ADSON BROWN	50	H	
DRIVER, PIN	65	FORCEPS, ADSON GRAEFE	50	HAIRSTYLE, SCISSORS, SCREW	158
DRUGMATIC, DRENCHING SYRINGE	136	FORCEPS, ALLIS	51	HALSTEAD MOSQUITO FORCEPS	51
DRYSOFT®, ABSORBENT PAD	76	FORCEPS, BURDIZZO, CASTRATION	142	HAND GEL, GÉNIA CLEAN	130
DYNAMIC COMPRESSION PLATE	64	FORCEPS, CAESAREAN	56	HANDLE, BOLUS APPLICATOR	153
		FORCEPS, CASTRATION	142	HANDLE, SAW WIRE	146
		FORCEPS, CHERON	143	HANDLE, SCALPEL	44
E		FORCEPS, CRILE	51	HANDLE, SCALPEL	44
EASY, SYRINGE, PROJECTOR	100	FORCEPS, DEBAKEY	50	HANDY CANIS, HARNESS	67
ECHOGRAPHY GEL	125	FORCEPS, DISSECTION	50	HANGER, BOTTLE, AUTOMATIC SYRINGE	12-13
ECOGAN, EXPLORATION GLOVE	122	FORCEPS, FOREIGN BODY, HARTMANN	52	HANGER, E-COLLARS, COSYPAD®	70
E-COLLAR	70-73	FORCEPS, GRAEFE	50	HARNESS, INJECTION, DRENCHING, POUR-ON	17, 139
E-COLLAR, HANGER	70	FORCEPS, HALSEAD MOSQUITO	51	HARNESS, REHABILITATION	67
ECOMAG, CAGE MAGNET	153	FORCEPS, HARTMANN	52	HARTMANN FORCEPS	52
EF, SUTUREC, SUTURE NEEDLE	43	FORCEPS, HEMOSTATIC	51	HEMOSTATIC FORCEPS	51
EF2, SUTUREC, SUTURE NEEDLE	43	FORCEPS, HOOF TESTER	156	HOG CATCHER	140
EF3, SUTUREC, SUTURE NEEDLE	43	FORCEPS, KELLY	51	HOHMANN RETRACTOR	66
EJECTOR, CARTRIDGE	97	FORCEPS, MICRO ADSON	50	HOLDER, CO ₂ CAPSULE, PROJECTOR	94
EKOGE, ECHOGRAPHY GEL	125	FORCEPS, RIGHT ANGLE CLAMP	51	HOLDER, NEEDLE	49
ELECTRIC PROD, VILLETTE®	140	FORCEPS, ROCHESTER PEAN	51	HOLDING KENNEL, CAT	112
ELEPHANT, SYRINGE CANNULA, PROJECTOR	103	FORCEPS, SPIKELET, HARTMANN	52	HOOF CARE, ACCESSORY	156
ELPLEX®, SYRINGE	11	FORCEPS, STANDARD, DISSECTION	50	HOOF KNIFE, FARRIER RANGE	154
EMASCULATOR	142	FORCEPS, TOWEL CLIP, SURGICAL DRAPE	50	HOOF OINTMENT, CICABOM	156
EMASCULATOR, REIMER'S, SAND	142				

HOOF, RINGLAND	155	KEY, BONE PIN CHUCK	66	MONOFIL, ABSORBABLE SYNTHETIC SUTURE	38
HOOF SCRAPER	156	KILLIAM SPECULUM	52	MONOJECT, NEEDLE	20
HOOF TESTER	156	KNIFE, FARRIER RANGE, HOOF	154	MORTON, SWANN, SCALPEL BLADE	44
HOOFLAND, HOOF KNIFE	156	KNIFE, NECROPSY	53	MOSQUITO, HALSTEAD FORCEPS	51
HOOFSCARP, HOOF KNIFE	156	KNIFE, SAGE, BEVELLED BLADE	155	MOUTH GAGS, CLIMAX	149
HOOK, OVARIECTOMY	52	KNIFE, VETERINARY RANGE, HOOF	155	MOUTH GAGS, SCHOUBE	149
HOOK, REPTILE	118-119	K-STAR®, ANTI-PINCH DEVICE, INFUSION SET	33		
HORSE, MOUTH GAGS	149			N	
HORSE, WOLF TOOTH, DENTAL FORCEPS	149	L		NASOESOPHAGEAL TUBE	151
HOSPITALIZATION	69-86	LACFIL, ABSORBABLE SYNTHETIC SUTURE	39	NASOFLEX, TUBE AND PUMP	151
HUB, HYPODERMIC SYRINGE	16	LACRIMAL, CATHETER	36	NECKY, E-COLLAR	72
HYDRO, ANIPLAST® DRESSING	81	LACTATION CARE	145	NECROPSY KNIFE	53
HYDROGEL CURAFIL DRESSING	82	LANDING NET, CAPTURE	116	NECROPSY SCISSORS	53
HYDROPHILIC FOAM DRESSING	82	LARGE ANIMAL RESTRAINT	140	NEEDLE, ACCESSORY	23
HYGIENE	127-134	LASCAP, POLE	109	NEEDLE, AIR	23
HYGIENE, HAND	130	LASER POINTER	98	NEEDLE, ALUMINIUM HUB	20
HYPODERMIC, DISPOSABLE DETECTABLE NEEDLE	22	LASER RANGEFINDER	98	NEEDLE, BONNEY'S	43
HYPODERMIC, DISPOSABLE NEEDLE	20-22	LATEX, EXAMINATION GLOVE, EXAMED	124	NEEDLE, BÜHNER, SUTURE	56
HYPODERMIC, DISTINJECT MATERIAL	89-106	LATEX, SURGERY GLOVE, SURGITEK	124	NEEDLE, CAESAREAN	56
HYPODERMIC, REUSABLE NEEDLE	18-19	LEAD, BULL	140	NEEDLE, DETECTABLE, ALU-DETECT®	22
HYPODERMIC SYRINGE	8-17	LIGAMENT REPAIR, SURGICAL BUTTON	66	NEEDLE, DETECTABLE, DISPOSABLE	22
HYPODERMIC, SYRINGE SYRMAN	11	LIGHTER GAS REFILL	104	NEEDLE, DETECTABLE, PLASTI-DETECT®	22
HYPOJET®, NEEDLE	20	LINEN, SUTURE	40	NEEDLE, DISPOJECT®, DISPOSABLE	21
HYSTERECTOMY, C-CUT	56	LINGERE SCISSORS	48	NEEDLE, DISPOSABLE, HYPODERMIC	20-22
		LISTER SCISSORS	48	NEEDLE, DOUBLE TRANSFER	33
I		LIVESTOCK	133-156	NEEDLE, GENALU	20
IDENTIFICATION, BAND	141	LONG, GÉNIAMATIC SYRINGE	9	NEEDLE, GERLACH BÜHNER	56
IDENTIFICATION, LARGE ANIMAL	154-156	LONG, GÉNIAPLEX SYRINGE	8	NEEDLE HOLDER	49
IDENTIFICATION, SMALL ANIMAL	83	LONG, METALPLEX® SYRINGE	10	NEEDLE HOLDER, BOYTON	49
IDENTIX SPRAY, MARKING SPRAY	141	LONG, ROUX SYRINGE	12	NEEDLE HOLDER, CRIL WOOD	49
IMMOBILIZATION MATTRESS, VACUUMAT®	76	LOTION, GENTLE CLEANSING, GÉNIA CLEAN	130	NEEDLE HOLDER, GILLIES	49
IMOMÉTAL, IMOVEINE	32	LUBRICANT, EKOGEL, ECHOGRAPHIC GEL	125	NEEDLE HOLDER, MATHIEU	49
IMOPLAST, DISPOSABLE IMOVEINE	32	LUBRICANT, EXPLOGEL®, EXPLORATION GEL	125	NEEDLE HOLDER, MAYO HEGAR	49
IMOVALVE, IMOVEINE	32	LUBRICANT, SILIGLISS	17, 104	NEEDLE HOLDER, OLSEN HEGAR	49
INFUJECT, EXTENSION	27			NEEDLE, HYPODERMIC	18-24
INFUJECT-SITE, EXTENSION	27	M		NEEDLE, HYPODERMIC, DISPOSABLE	20-22
INFUJECT-TRIO, EXTENSION	27	MACHINE, TATOING	83	NEEDLE, HYPODERMIC, REUSABLE	18-19
INFUSION SET	27-33	MAGNET, CAGE	153	NEEDLE, HYPOJET®	20
INFUSION SET, ANTI-PINCH DEVICE, K-STAR®	33	MAGNET, CATTLE, BOVIMAG®	153	NEEDLE, MONOJECT	20
INFUSION SET, EXTENSION, PERFUVET® TWIST	30	MAGNETS, BOLUS APPLICATOR	152-153	NEEDLE, OLIVE-TIP	23
INFUSION SET, SAMPLING, CATHETER	25-36	MAINTENANCE OF GAS PROJECTOR	95	NEEDLE, POST-MORTEM	43
INJECTION	7-36	MALE CAP	33	NEEDLE, PRIMAJECT®, DISPOSABLE	21
INJECTION, CAPSULES	102	MANUAL, SYRINGE	8,10-11,14-15	NEEDLE, RUMEN	23
INJECTION, EXTENSION STICK	17, 106	MARKER PEN PENMARK®	141	NEEDLE, SERPENTINE, SUTURE	43
INJECTION, HARNESS	17, 139	MARKER PENMARK®	141	NEEDLE, SPECIFIC	23
INJECTION STICK	17, 106	MARKING SPRAY	141	NEEDLE, SUTURE	43
INJECTMASTER®, SYRINGE	13	MATERIAL, CAPTURE	107-120	NEEDLE, SUTUREC	43
INK, TATOING MACHINE	83	MATERIAL, HYPODERMIC	89-106	NEEDLE, SUTUREC EXTRA FINE EF	43
INK, TATOING, PIG, TATOOMARK	141	MATERIAL, SURGERY, LARGE ANIMAL	55-56	NEEDLE, SUTUREC EXTRA FINE EF2/EF3	43
INSEMINATION, GLOVE	122-123	MATERIAL, SUTURE	38-43	NEEDLE, SYRINGE, PROJECTOR	101, 103
INSTRUMENT, MEASURE, DIAGNOSTIC	147-148	MATHIEU, NEEDLE HOLDER	49	NEEDLE, TATOING MACHINE	83
INSTRUMENTATION, CLEANSING	128, 132	MATTRESS, IMMOBILIZATION, VACUUMAT®	76	NEEDLE, WASTE CONTAINER	23
INSTRUMENTATION, SURGERY	44-56	MAXOGAN, EXPLORATION GLOVE	123	NEOCOL®, E-COLLAR	71
INSULIN, SAFETY, DISPOJECT® SYRINGE	15	MAYO HEGAR, NEEDLE HOLDER	49	NITRILE, EXAMINATION GLOVE, VETRILE	124
INSULIN, STANDARD, DISPOJECT® SYRINGE	15	MAYO SCISSORS	46	NON-ABSORBABLE, SUTURE	40
INTRAFLON, CATHETER	26	MAYO SERRATED SCISSORS	46	NOZZLE, DELVO	18
INTRANULE, CATHETER	26	MAYO STILLE SCISSORS	46	NOZZLE, DERMASTEEL	19
INTUBATION, BALLOON, CATHETER	36	MEASURE, DIAGNOSTIC, INSTRUMENT	147-148	NOZZLE, DRENCHING GUN	138
IODE, STAIN REMOVER, BETANETT	132	MEASURING TAPE, ZOOMETRIC	147	NOZZLE, DRENCHING, HYPODERMIC SYRINGE	17, 138
IODINE REMOVER, GÉNIA CLEAN	129	MEDICAL SCISSORS	48	NOZZLE, FEEDING	137
IRIDECTOMY SCISSORS	47	METALPLEX®, LONG SYRINGE	10	NOZZLE, FORCE-FEEDING	137
		METALPLEX®, SYRINGE	10	NUT, SET OF 3, AUTOMATIC SYRINGE	13
J		METZENBAUM SCISSORS	46		
JUNIOR, YLG TATOING MACHINE	83	MICRO, ADSON FORCEPS	50	O	
		MILK SUCKING PREVENTOR, ALUMINIUM	144	OINTMENT, HOOF, CICABOM	156
K		MILK SUCKING PREVENTOR, PLASTIC	144	OLIVE-TIP NEEDLE	23
KELLY FORCEPS	51	MILKING, GOWN, VELVET	126	OLSEN HEGAR, NEEDLE HOLDER	49
KENNEL, FOLDING	113	MINI-JECT, 11 MM BLOWPIPE	89	OPEN END, URINARY CATHETER UROLENE®	34
KENNEL, POUND	112	MINI-JECT, SYRINGE, PROJECTOR	100	OPERATION, DISPOSABLE SURGICAL DRAPE	54
KENNEL, TRANSPORT	112-114	MOBILITY CART, CANIS-MOBILE®	68	OPHTHALMIC SCISSORS	47
		MONKEY, PROTECTIVE GLOVE	120	ORALPLEX, DRENCHING SYRINGE	136

■ BY REFERENCE

1

100002	8	103004	11	107142	14	147016	18	147415	18	147764	21
100003	8	103005	11	107144	14	147019	18	147418	18	147766	21
100004	8	103006	11	107146	14	147022	18	147421	18	147768	21
100006	8	103010	11	107148	14	147025	18	147423	18	147770	21
100007	8	103011	11	107150	14	147028	18	147424	18	147772	21
100008	8	103012	11	107152	14	147031	18	147427	18	147774	21
100010	8	103013	11	107154	14, 137	147034	18	147430	18	147776	21
100012	8	103014	11	107162	14	147037	18	147433	18	147778	21
100014	8	103504	11	107164	14	147040	18	147435	18	147780	21
100016	8	103505	11	107166	14	147043	18	147436	18	147886	19
100018	8	103506	11	107168	14	147046	18	147437	18	147890	19
100020	8	104000	11	107262	12	147048	18	147438	18	147891	19
100022	8	104002	11	107270	12	147049	18	147439	18	147894	19
100024	8	104003	11	107509	137	147052	18	147440	18	147903	19
100026	8	104004	11	107510	137	147053	18	147442	18	147906	19
100028	8	104005	11	107511	137	147055	18	147443	18	147910	19
100032	8	104800	11	107800	12	147058	18	147445	18	147911	19
100034	8	104801	11	107803	12	147061	18	147448	18	147913	19
100036	8	104804	11	107805	12	147064	18	147451	18	147914	19
100038	8	104850	8	107810	12	147067	18	147454	18	147917	19
100040	8	105000	12	107861	12	147070	18	147456	18	147920	19
100046	8	105002	12	107862	12	147073	18	147458	18	147921	19
100048	8	105010	12	109253	16	147076	18	147460	18	147922	19
100050	8	105012	12	109257	16	147078	18	147468	18	147923	19
100410	8	105020	12	109265	16, 139	147080	18	147470	18	147924	19
100412	8	105022	12	109266	16, 139	147082	18	147472	18	147925	19
100414	8	105025	12	109267	16	147085	18	147473	18	147926	19
100416	8	105027	12	109268	16	147086	137	147476	18	147931	19
100418	8	105080	12	109269	16, 139	147090	23	147485	20	147933	19
100451	9	105082	12	109270	16, 136, 139	147275	20	147602	21	147934	19
100453	9	105085	12	109300	16-17	147277	20	147604	21	147935	19
100470	9	105087	12	109302	16	147278	20	147608	21	147936	19
100530	8	106002	17	109304	16	147280	20	147616	21	147940	19
100531	8	106007	17	109306	16	147282	20	147618	21	147941	19
100532	8	106008	16-17	109308	16	147283	20	147624	21	147942	19
100533	8	106020	104	109310	16	147284	20	147634	21	147943	19
100534	8	106021	17	109312	16	147290	20	147650	43	147944	19
102020	10	106023	17	109314	16	147360	20	147655	43	147945	19
102021	10	106024	17	109332	32	147361	20	147660	43	147946	19
102022	10	106025	17	129280	141	147362	20	147665	43	147951	19
102023	10	106030	16	140481	32	147363	20	147670	43	147953	19
102024	10	106032	16	140482	16	147364	20	147685	43	147954	19
102030	10	106033	16	140483	32	147365	20	147690	43	147955	19
102031	10	106034	16	140500	32	147366	20	147691	43	147956	19
102032	10	106040	23	140501	32	147367	20	147692	43	147959	19
102033	10	106041	23	140502	32	147368	20	147694	20	147960	19
102034	10	106043	16	140504	9, 12-13	147369	20	147696	20	147962	19
102210	10	106046	16	140512	32	147371	20	147700	20	147963	19
102211	10	106048	16-17	140514	32	147372	20	147702	20	147964	19
102212	10	106050	16	140515	32	147373	20	147704	20	147965	19
102213	10	106051	16	140520	33	147374	20	147706	20	147966	19
102214	10	106080	13	140521	33	147376	20	147708	20	147970	19
102600	10	106155	13	140524	33	147392	20	147710	20	147971	19
102602	10	106196	12, 136	140533	32	147399	18	147750	21	147972	19
102603	10	107031	137	140535	33	147400	18	147752	21	147973	19
102605	10	107135	15	140536	33	147403	18	147754	21	147974	19
103002	11	107136	15	147003	18	147404	18	147756	21	147975	19
103003	11	107140	14	147010	18	147406	18	147757	21	147976	19
				147011	18	147409	18	147758	21	147977	19
				147013	18	147411	18	147760	21	148218	22
				147015	18	147412	18	147762	21	148220	22

148285	22	157711	43	180302	135	187032	11, 16	192114	102	192262	100
148287	22	157712	43	180305	135	187036	17	192120	103	192264	100
148290	22	157713	43	180306	135	187038	138	192122	103	192266	100
148292	22	157720	43	180308	135	187040	138	192124	103	192268	100
148295	22	157721	43	180310	135	187042	138	192126	103	192270	100
148300	22	157722	43	180314	135	187044	138	192128	103	192272	100
148303	22	157723	43	180320	135	187046	138	192130	103	192274	100
148305	22	157724	43	180324	135	189501	139	192132	103	192276	101
148308	22	157725	43	180326	135	189503	139	192134	103	192280	104
148310	22	157726	43	180330	136	189506	139	192136	103	192290	102
148312	22	157727	43	180336	136	189509	139	192138	103	192292	102
148314	22	157728	43	186010	138	189512	139	192140	103	192294	102
148500	23	157740	43	186012	138	189514	139	192142	103	192296	97
148502	23	157741	43	186014	138	189624	138	192144	103	192298	97
148503	23	157742	43	186016	138	189625	8, 11, 138	192146	103	192300	97
157190	26	157743	43	186017	138	189645	138	192148	103	192302	97
157192	26	157744	43	186018	138	189646	138	192150	103	192304	97
157194	26	157745	43	186020	138	189647	138	192152	103	192306	97
157196	26	157746	43	186022	138	189674	138	192154	103	192320	104
157198	26	157760	43	186024	138	189676	138	192156	103	192324	97
157200	26	157761	43	186044	135, 138	189690	138	192158	103	192326	97
157202	26	157764	43	186046	138	190000	134	192160	103	192328	104
157204	26	157766	43	186048	138	190002	134	192162	103	192332	97
157208	26	157850	25	186050	138	190004	134	192164	103	192336	97
157209	26	157852	25	186052	138	190006	134	192166	103	192337	104
157210	26	157854	25	186054	138	190008	134	192168	103	192338	101
157212	26	157856	25	186056	138	190010	134	192180	102	192340	101
157214	26	180002	136	186060	138	190012	134	192182	102	192342	104, 106
157216	26	180004	136	186062	138	190015	134	192184	103	192344	94
157268	26	180018	136	186308	13	191052	33	192185	101	192345	94
157270	26	180020	136	186309	13	191054	33	192186	103	192346	94
157271	26	180022	136	186310	13	191061	84	192188	103	192347	94
157272	26	180026	136	186311	13	192000	93	192189	103	192348	94
157274	26	180028	136	186312	13	192004	93	192190	103	192350	95
157319	27	180030	136	186313	13	192008	92	192192	102	192351	95
157330	33	180032	136	186314	13	192012	96	192194	102	192352	95
157393	31	180049	136	186315	13	192016	96	192200	102	192353	95
157394	28	180050	136	186316	13	192020	92	192202	102	192357	95
157395	28	180052	136	186317	13	192030	89	192204	102	192358	95
157396	31	180055	136	186318	13	192031	89	192206	102	192359	95
157397	29	180056	136	186319	13	192032	90	192208	102	192361	95
157398	29	180057	136	186320	13	192034	90	192210	102	192370	106
157399	27	180058	136	186321	13	192036	89	192212	102	192372	106
157400	27	180059	136	186322	13	192037	89	192214	102	192374	106
157404	27	180060	135	186323	13	192048	98	192216	105	192376	106
157405	27	180065	135	186324	13	192050	98	192218	105	192378	106
157406	27	180070	135	186325	13	192052	98	192220	105	192380	106
157407	27	180072	135	186326	13	192053	98	192222	100	192400	107
157450	30	180075	135	186327	13	192054	98	192240	101	192402	107
157451	30	180078	135	186328	13	192062	98	192242	101	192404	107
157452	30	180079	135	186329	13	192064	98	192243	101	192406	107
157590	144	180080	135	186330	13	192066	94	192244	101	192408	107
157696	43	180085	135	186331	13	192068	94	192246	101	192409	107
157698	43	180087	135	186790	13	192080	119	192248	101	192421	107
157700	43	180090	135	187003	139	192100	102	192250	101	192422	107
157701	43	180095	135	187006	139	192102	102	192252	101	192424	107
157702	43	180110	135	187007	139	192104	102	192254	101	192440	115
157703	43	180115	135	187009	139	192106	102	192256	101	192441	117
157704	43	180117	135	187010	33, 139	192108	102	192257	101	192443	115
157708	43	180141	138	187011	33, 139	192110	102	192258	101	192444	117
157710	43	180300	135	187030	23	192112	102	192260	100	192445	117

192447	117	215100	152	220405	150	227022	85	227666	125	260207	65
192448	117	215120	152	220410	150	227023	145	227682	125	260208	65
192462	118	215130	152	220415	150	227024	145	227684	125	260209	65
192466	118	215140	152	220450	150	227028	140	227800	150	260570	68
192467	119	215150	152	220455	150	227029	140	227812	153	260571	68
192468	118	215160	152	220460	150	227030	140	227815	153	260574	68
192472	116	215180	153	220500	144	227032	149	227817	153	260575	68
192480	116	215192	153	220600	150	227033	149	227820	153	260580	68
192490	119	215195	153	220602	150	227037	143	227840	146	260581	68
192491	119	220002	155	220800	56	227038	144	227842	146	261002	65
192492	119	220004	155	220805	56	227039	140	227844	146	261004	65
192493	119	220006	155	220810	56	227040	140	227846	156	261012	66
192494	119	220008	155	220840	146	227050	155	227847	156	261014	66
192495	119	220010	155	220850	56	227051	155	227860	53	261017	66
192496	119	220020	155	220852	56	227052	144	227862	53	261021	66
192497	119	220022	155	220890	56	227061	145	227900	56	261022	66
192504	116	220024	155	220892	56	227066	145	227901	56	264444	62
192506	116	220026	155	220894	56	227071	145	227902	56	264446	62
192550	110	220030	155	220900	83	227076	56	227903	56	264448	62
192552	110	220032	155	220902	141	227077	56	227970	86	264450	62
192554	110	220050	155	220904	83	227081	147	227972	86, 147	264462	62
192556	110	220051	154	220906	83	227082	147	227978	86, 147	264464	62
192558	111	220052	155	221000	140	227086	85	257810	153	264466	62
192560	111	220054	155	221002	140	227087	56	259912	61	264468	62
192610	112	220100	154	221003	140	227100	156	259914	61	264470	62
192612	112	220102	154	221350	109	227102	156	259916	61	264472	62
192614	112	220107	154	221351	109	227103	156	259918	61	264474	62
192616	112	220108	154	221352	109	227104	156	259920	61	264476	62
192620	114	220110	154	221354	109	227108	83	259922	61	264478	62
192622	113	220112	154	221355	109	227110	83	259924	61	264480	62
192624	113	220120	154	221356	109	227111	83	259926	61	264482	62
192626	113	220122	154	221357	109	227222	156	259928	61	264484	62
192628	113	220134	154	221430	108	227230	85	259930	61	264486	62
192630	113	220136	154	221432	108	227250	67	259932	61	264488	62
192640	114	220140	154	221434	108	227252	67	260019	61	264490	62
192642	114	220142	154	221500	83	227254	67	260020	61	265500	62
192644	114	220148	154	222000	151	227256	67	260022	61	265501	62
192646	114	220149	154	222002	151	227258	67	260023	61	265502	62
192648	114	220150	155	222004	151	227296	17, 139	260024	61	265503	62
192650	114	220151	154	222006	151	227300	148	260026	61	265504	62
192656	113	220164	155	222020	151	227302	148	260027	61	265506	62
192750	120	220166	155	223000	148	227304	148	260028	61	265508	62
192752	120	220168	155	223001	148	227340	140	260030	61	265510	62
192754	120	220199	156	223002	148	227342	140	260032	61	265512	62
192756	120	220200	156	223004	148	227500	145	260034	61	265514	62
192880	95	220202	156	223005	148	227510	141	260046	61	265568	62
192886	95	220210	156	223007	148	227512	141	260047	61	265570	62
192888	97	220213	156	223008	148	227514	141	260048	61	265572	62
192890	97	220214	156	223010	148	227520	141	260049	61	265574	62
192895	95	220220	156	223011	148	227522	141	260160	61	265576	62
192896	95	220226	156	223012	148	227524	141	260162	61	265578	62
192990	95	220291	150	223013	148	227628	141	260164	61	265580	62
		220300	150	223100	146	227630	141	260168	61	265582	62
		220305	150	227005	151	227632	141	260170	61	265584	62
		220310	150	227010	151	227634	141	260200	65	265586	62
215000	152	220315	150	227013	151	227636	141	260201	65	265588	62
215030	152-153	220330	150	227014	151	227638	141	260202	65	265590	62
215040	152	220335	150	227015	151	227640	141	260203	65	265592	62
215060	152-153	220340	150	227016	151	227660	125	260204	65	265594	62
215070	152	220360	52	227020	151	227662	125	260205	65	265636	62
215080	152	220400	55, 150	227021	85	227664	125	260206	65	265638	62

2

265640	62	266022	64	26A2012	59	26B3025	59	26G1515	59	26M1415	59
265642	62	266024	64	26A2015	59	26B3030	59	26G1815	59	26M1420	59
265644	62	266026	64	26A2020	59	26B3520	59	26G2015	59	26M1430	59
265646	62	266028	64	26A2025	59	26B3525	59	26G3015	59	26M1512	59
265648	62	266030	64	26A2030	59	26B3530	59	26K1010	59	26M1515	59
265650	62	266032	64	26A2512	59	26B4020	59	26K1012	59	26M1520	59
265652	62	266034	64	26A2520	59	26B4025	59	26K1015	59	26M1525	59
265654	62	266036	64	26A2530	59	26B4030	59	26K1020	59	26M1530	59
265656	62	266038	64	26A3012	59	26B5025	59	26K1030	59	26M1620	59
265658	62	266040	64	26A3015	59	26B5030	59	26K1210	59	26M1630	59
265660	62	266042	64	26A3020	59	26B6025	59	26K1212	59	26M1812	59
265662	62	266044	64	26A3025	59	26B6030	59	26K1215	59	26M1820	59
265664	62	266046	64	26A3030	59	26B7025	59	26K1220	59	26M1830	59
265666	62	266048	64	26A3520	59	26B7030	59	26K1230	59	26M2012	59
265668	62	266050	64	26A3530	59	26B8030	59	26K1415	59	26M2015	59
265670	62	266052	64	26A4020	59	26E1012	60	26K1420	59	26M2020	59
265672	62	266054	64	26A4025	59	26E1020	60	26K1425	59	26M2025	59
265674	62	266056	64	26A4030	59	26E1025	60	26K1430	59	26M2030	59
265676	62	266058	64	26A5025	59	26E1430	60	26K1510	59	26M2212	59
265678	62	266060	64	26A5030	59	26E1520	60	26K1512	59	26M2220	59
265706	62	266062	64	26A6030	59	26E1525	60	26K1515	59	26M2230	59
265708	62	266064	64	26A8030	59	26E1530	60	26K1520	59	26M2512	59
265710	62	266066	64	26B0812	59	26E1630	60	26K1530	59	26M2515	59
265712	62	266068	64	26B0830	59	26E1820	60	26K1612	59	26M2520	59
265714	62	266070	64	26B1010	59	26E1830	60	26K1620	59	26M2525	59
265716	62	266072	64	26B1012	59	26E2025	60	26K1630	59	26M2530	59
265718	62	266074	64	26B1020	59	26E2030	60	26K1812	59	26M3012	59
265720	62	266076	64	26B1025	59	26E2230	60	26K1820	59	26M3015	59
265722	62	266150	63	26B1030	59	26E2520	60	26K2010	59	26M3020	59
265724	62	266152	63	26B1212	59	26E2525	60	26K2012	59	26M3025	59
265726	62	266154	63	26B1220	59	26E2530	60	26K2015	59	26M3030	59
265728	62	266156	63	26B1230	59	26E3020	60	26K2020	59	26M3520	59
265730	62	266158	63	26B1415	59	26E3025	60	26K2025	59	26M3525	59
265732	62	266160	63	26B1420	59	26E3030	60	26K2030	59	26M3530	59
265734	62	266170	63	26B1430	59	26E3520	60	26K2512	59	26M4020	59
265736	62	266172	63	26B1512	59	26E3525	60	26K2520	59	26M4025	59
265738	62	26A1010	59	26B1515	59	26E3530	60	26K2530	59	26M4030	59
265740	62	26A1012	59	26B1520	59	26E4020	60	26K3012	59	26M5025	59
265742	62	26A1015	59	26B1525	59	26E4025	60	26K3015	59	26M5030	59
265744	62	26A1020	59	26B1530	59	26E4030	60	26K3020	59	26M6025	59
265746	62	26A1030	59	26B1620	59	26E4525	60	26K3025	59	26M6030	59
265748	62	26A1210	59	26B1630	59	26E5030	60	26K3030	59	26M7025	59
265750	62	26A1212	59	26B1812	59	26E6030	60	26K3520	59	26M7030	59
265752	62	26A1215	59	26B1820	59	26F1020	60	26K3530	59	26M8030	59
265754	62	26A1220	59	26B1830	59	26F1220	60	26K4020	59	26T1012	60
265756	62	26A1230	59	26B2012	59	26F1420	60	26K4025	59	26T1020	60
265758	62	26A1415	59	26B2015	59	26F1520	60	26K4030	59	26T1025	60
265760	62	26A1420	59	26B2020	59	26F1620	60	26K5025	59	26T1430	60
265762	62	26A1425	59	26B2025	59	26F1820	60	26K5030	59	26T1520	60
265764	62	26A1430	59	26B2030	59	26F2020	60	26K6030	59	26T1525	60
265766	62	26A1510	59	26B2212	59	26F2520	60	26K8030	59	26T1530	60
266002	64	26A1512	59	26B2220	59	26F2525	60	26M0812	59	26T1630	60
266004	64	26A1515	59	26B2230	59	26F3025	60	26M0830	59	26T1820	60
266006	64	26A1520	59	26B2512	59	26F3525	60	26M1010	59	26T1830	60
266008	64	26A1530	59	26B2515	59	26F4025	60	26M1012	59	26T2025	60
266010	64	26A1612	59	26B2520	59	26F4030	60	26M1020	59	26T2030	60
266012	64	26A1620	59	26B2525	59	26F5030	60	26M1025	59	26T2230	60
266014	64	26A1630	59	26B2530	59	26F6030	60	26M1030	59	26T2520	60
266016	64	26A1812	59	26B3012	59	26G0815	59	26M1212	59	26T2525	60
266018	64	26A1820	59	26B3015	59	26G1015	59	26M1220	59	26T2530	60
266020	64	26A2010	59	26B3020	59	26G1215	59	26M1230	59	26T3020	60

26T3025	60	306410	72	307203	77	307748	124	307987	142	327022	81
26T3030	60	306412	72	307206	77	307760	124	307988	142	327030	81
26T3520	60	306413	72	307207	77	307761	124	307990	142	327032	81
26T3525	60	306414	72	307208	77	307762	124	307994	142	327040	80
26T3530	60	306416	72	307209	77	307763	124	307995	142	327042	80
26T4020	60	306420	70	307212	77	307769	124	307996	142	327050	76
26T4025	60	306422	70	307213	77	307770	124	307997	142	327052	76
26T4030	60	306424	70	307214	77	307771	124	307999	142	327054	76
26T4525	60	306426	70	307215	77	307772	124	308001	142	327056	76
26T5030	60	306428	70	307216	77	307800	79	308002	142	327200	75
26T6030	60	306430	70	307220	77	307801	79	317102	35	327201	75
277600	141	306432	70	307222	77	307805	79	317104	35	327203	75
277606	141	306438	70	307230	77	307806	79	317106	35	327205	75
		306450	73	307232	77	307810	79	317136	137	327211	74
		306452	73	307234	77	307811	79	317178	54	327212	74
3		306454	73	307240	77	307820	79	317180	54	327213	74
300015	36	306456	73	307241	77	307822	79	317182	54	327302	76
306000	72	306458	73	307242	77	307824	79	317184	54	327304	76
306002	72	306460	73	307243	77	307826	79	317205	130	327306	76
306004	72	306462	73	307250	78	307828	79	317210	132	33C0810	60
306006	72	306468	73	307252	78	307830	79	317247	132	33C1012	60
306008	72	306898	34	307254	78	307832	79	317248	132	33C1212	60
306010	72	306900	34	307256	78	307834	79	317250	132	33C1512	60
306012	72	306902	34	307280	78	307860	23	317256	132	33C1815	60
306013	72	306904	34	307282	78	307865	23	317408	129	33C2015	60
306014	72	306908	34	307290	78	307880	125	317410	129	33C2515	60
306016	72	306920	34	307292	78	307882	125	317412	128	33C3020	60
306100	70	306922	34	307294	78	307884	125	317414	130	33C3520	60
306102	70	306924	34	307296	78	307886	125	317420	130	33C4020	60
306104	70	306926	34	307320	36	307890	126	317422	130	33P0810	60
306106	70	306928	34	307322	36	307892	126	317440	129	33P1012	60
306108	70	306940	34	307324	36	307900	149	317442	129	33P1212	60
306110	70	306942	34	307326	36	307901	149	317444	129	33P1512	60
306112	70	307020	78	307328	36	307902	149	317446	128	33P1812	60
306116	70	307022	78	307330	36	307903	149	31C0810	60	33P2012	60
306117	70, 75	307024	78	307400	53	307904	149	31C1012	60	33P2512	60
306200	70	307026	78	307401	53	307905	149	31C1212	60	33P3015	60
306202	70	307028	78	307410	53	307907	149	31C1512	60	33P3515	60
306204	70	307030	78	307610	122	307908	149	31C1815	60	33P4015	60
306206	70	307072	82	307611	122	307920	48	31C2015	60	340000	55
306208	70	307083	82	307613	122	307922	53	31C2515	60	340007	55
306210	70	307087	82	307620	123	307926	148	31C3020	60	340010	55
306212	70	307102	36	307623	123	307943	44	31C3520	60	340019	55
306213	70	307104	36	307626	122	307944	44	31C4020	60	340020	66
306214	70	307110	35	307627	122	307949	44	31P0810	60	340030	66
306216	70	307112	35	307629	122	307950	44	31P1012	60	340480	40
306218	70	307120	35	307640	126	307952	44	31P1212	60	340500	40
306300	70	307122	35	307650	122	307956	44	31P1512	60	340502	40
306302	70	307124	35	307656	126	307958	53	31P1812	60	340504	40
306304	70	307126	35	307658	126	307959	53	31P2012	60	340506	40
306306	70	307130	36	307660	126	307963	44	31P2512	60	340508	40
306308	70	307132	36	307685	126	307965	44	31P3015	60	340510	40
306310	70	307133	36	307698	124	307970	44	31P3515	60	340512	40
306312	70	307134	36	307700	124	307975	52	31P4015	60	340514	40
306314	70	307135	137	307702	124	307976	52	327000	81	340522	40
306315	70	307136	137	307704	124	307978	142	327002	81	340554	40
306316	70	307138	137	307706	124	307980	52	327006	81	340556	40
306400	72	307139	137	307708	124	307983	142	327008	81	340558	40
306402	72	307200	77	307745	124	307984	145	327014	81	340560	40
306404	72	307201	77	307746	124	307985	56	327016	81	340562	40
306406	72	307202	77	307747	124	307986	142	327020	81	340564	40

340566	40	340990	38	600400	46	607014	49
340568	40	340991	38	600401	46	607016	49
340570	40	342000	39	600402	46	607018	49
340604	40	342001	39	600410	46	607020	49
340606	40	342002	39	600411	46	607022	49
340608	40	342003	39	600452	46	607024	49
340612	40	342004	39	600458	46	607028	49
340652	40	342006	39	600459	46	607030	49
340654	40	342008	39	600460	46	607032	49
340656	40	342009	39	600490	46	630000	66
340658	40	342010	39	600493	46	630010	52, 66
340660	40	342012	39	600494	46	650001	50
340662	40	342014	39	600495	46	650012	50
340664	40	342016	39	600502	46	650031	50
340810	39	342018	39	600505	46	650320	50
340811	39	342020	39	600506	46	650322	50
340812	39	342022	39	600512	46	650330	50
340813	39	342024	39	600515	46	650332	50
340814	39	342026	39	600530	46	650335	50
340815	39	342028	39	600741	46	650460	50
340816	39	342030	39	600743	46	650495	50
340817	39	342032	39	600777	47	650498	50
340818	39	343014	38	600810	47	650580	50
340820	39	343015	38	600812	47	650882	50
340822	39	343016	38	600827	47	657000	51
340824	39	343018	38	600886	47	657004	51
340826	39	343020	38	600887	47	657006	51
340827	39	347015	55	600910	47	657008	51
340828	39			600911	47	657012	51
340829	39			600928	47	657014	51
340830	39	5		600929	47	657016	51
340831	39	500094	158	600935	47	657018	51
340832	39	500095	158	601165	65	657020	51
340834	39	500126	158	601170	65	657022	51
340836	39	500165	158	601239	48	657024	51
340838	39	500262/1	158	601255	47	657030	51
340838	39	500296/1	158	601256	47	657032	51
340839	39	505271/1	158	601258	47	657034	51
340840	39	505302/1	158	601258	47	657036	51
340890	39	505307/1	158	601259	47	657040	143
340891	39	599110	158	601313	48	657041	143
340892	39			601410	46	657052	51
340892	39			601412	46		
340893	39			601413	46		
340900	38	600122	48	601414	46		
340901	38	600123	48	601420	46		
340902	38	600124	48	601422	46		
340903	38	600129	48	601423	46		
340904	38	600130	48	601424	46		
340905	38	600170	48	601453	46		
340906	38	600202	48	601454	46		
340907	38	600273	46	601456	46		
340908	38	600275	46	601458	46		
340909	38	600303	46	601470	48		
340910	38	600319	46	601475	158		
340911	38	600322	46	601476	158		
340912	38	600340	46	607000	49		
340913	38	600342	46	607002	49		
340914	38	600370	46	607003	49		
340916	38	600372	46	607006	49		
340918	38	600375	46	607008	49		
340919	38	600377	46	607010	49		
340922	38	600378	46				

www.genia.fr

the veterinarian's preference... on the web !



*Find the catalog,
our new products and our news
on social networks and our website.*



22 | 23



Génia

Parc d'Activités Le Pont Béranger
12 rue Jean-François Champollion
44680 St. Hilaire de Chaléons - France

Tél : +33 (0)2 40 03 24 17 - Fax : +33 (0)2 40 03 14 71

genia@genia.fr

www.genia.fr

génia